



WEST VALLEY WATER DISTRICT
855 W. BASE LINE ROAD, RIALTO, CA 92376
PH: (909) 875-1804 FAX: (909) 875-1849

REGULAR BOARD MEETING
AGENDA

THURSDAY, OCTOBER 20, 2022
CLOSED SESSION - 6:00 PM • OPEN SESSION – 6:30 PM

BOARD OF DIRECTORS

Channing Hawkins, President
Greg Young, Vice President
Angela Garcia, Director
Dan Jenkins, Director
Kelvin Moore, Director

"In order to comply with legal requirements for posting of agendas, only those items filed with the District Secretary's office by noon, on Wednesday a week prior to the following Thursday meeting, not requiring departmental investigation, will be considered by the Board of Directors."

On March 4, 2020, Governor Newsom declared a State of Emergency resulting from the threat of COVID-19. On September 16, 2021, Governor Newsom signed Assembly Bill No. 361 into law. Assembly Bill No. 361 amends Government Code section 54953(e) by adding provisions for remote teleconferencing participation in meetings by members of a legislative body, without the requirements of Government Code section 54953(b)(3), subject to the existence of certain conditions. The West Valley Water District adopted a resolution determining, by majority vote, that, as a result of the declared State of Emergency, the District is adopting the State protocol which allows meetings in person and/or via teleconference. Accordingly, it has been determined that all Board and Workshop meetings of the West Valley Water District will be held pursuant to Assembly Bill No. 361, the Brown Act and will be conducted via teleconference and in person. Members of the public may listen and provide public comment via telephone by calling the following number and access code: Dial: (888) 475-4499, Access Code: 840-293-7790 or you may join the meeting using Zoom by clicking this link: <https://us02web.zoom.us/j/8402937790>. Public comment may also be submitted via email to administration@wvwd.org. If you require additional assistance, please contact administration@wvwd.org.

OPENING CEREMONIES

Call to Order
Pledge of Allegiance
Opening Prayer
Roll Call of Board Members

ADOPT AGENDA

PUBLIC PARTICIPATION

Any person wishing to speak to the Board of Directors on matters listed or not listed on the agenda, within its jurisdiction, is asked to complete a Speaker Card and submit it to the Acting Board Secretary, if you are attending in person. For anyone joining on Zoom, please wait for the Board President's instruction to indicate that you would like to speak. Each speaker is limited to three (3) minutes. Under the State of California Brown Act, the Board of Directors is prohibited from discussing or taking action on any item not listed on the posted agenda. Comments related to noticed Public Hearing(s) and Business Matters will be heard during the occurrence of the item.

Public communication is the time for anyone to address the Board on any agenda item or anything under the jurisdiction of the District. Also, please remember that no disruptions from the crowd will be tolerated. If someone disrupts the meeting, they will be removed.

PRESENTATIONS

- Introduction to Geographical Information Systems

CONSENT CALENDAR

All matters listed under the Consent Calendar are considered routine and will be enacted by one vote. There will be no separate discussion of these items unless a member of the Board of Directors, Staff Member, or any member of the public request a specific item(s) be removed for separate action.

Consideration of:

1. Bunker Hill Well Site Evaluation Ph2. **Pg. 6.**
2. Soft Start Motor Drive for 4-1 Pump Station. **Pg. 43.**
3. Cactus Basin 2 Maintenance Activities. **Pg. 50.**
4. Architectural Services for Building "C" Improvements. **Pg. 54.**
5. Ultraviolet Transmittance Meter for the Oliver P. Roemer Water Filtration Plant. **Pg. 73.**
6. Post Water-Main Break Street Repairs. **Pg. 81.**
7. Disposable Cartridge Filters for Ion Exchange Treatment Systems. **Pg. 87.**

8. Water Supply Assessment for Pepper 210 Commerce Center. **Pg. 93.**
9. Grant of Easement for the Oliver P. Roemer Upgrade and Expansion Project. **Pg. 142.**
10. Water System Infrastructure Install and Conveyance Agreement with Lennar. **Pg. 154.**
11. Contract Amendment: Classification and Compensation Study. **Pg. 178.**
12. Approval of Payment to Julia Sylva, Law Professional Services, in September 2022, Invoice No. 10159 for \$3,220.00. **Pg. 181.**
13. Approval of Payment to Hunt Ortmann, Professional Services, in September 2022, Invoice No. 95789 for \$4,818.00. **Pg. 182.**

BUSINESS MATTERS

Consideration of:

14. Award of Contract for the Construction of the Oliver P. Roemer Water Filtration Facility Upgrade and Expansion Project. **Pg. 183.**

REPORTS - LIMITED TO 5 MINUTES MAXIMUM (Presentations or handouts must be provided to Board Members in advance of the Board Meeting).

1. **Board Members**
2. **General Manager**
3. **Legal Counsel**

UPCOMING MEETINGS

- October 24, 2022 - External Affairs Committee Meeting at 6:00 p.m.
- October 25, 2022 - Policy Review Committee Meeting at 6:30 p.m.
- October 26, 2022 - Finance Committee Meeting at 6:00 p.m.
- November 5, 2022, Oliver P. Roemer Community, Tour. 9:00 a.m. - 11:00 a.m., Oliver P. Roemer Water Filtration Facility

UPCOMING COMMUNITY EVENTS

- Saturday, October 22, 2022, Irrigation and Water Capture (WVWD Workshop), 10:00 a.m. - 1:00 p.m. West Valley Water District

- Saturday, November 12, 2022, Irrigación y Colección de Agua (WVWD Workshop), 10:00 a.m. - 1:00 p.m. West Valley Water District

UPCOMING EDUCATION & TRAINING OPPORTUNITIES

- November 29 - December 1, 2022 - Association of California Water Agencies, 2022 Fall Conference (Indian Wells, CA)

CLOSED SESSION

- CONFERENCE WITH LEGAL COUNSEL - ANTICIPATED LITIGATION - Significant Exposure to Litigation Pursuant to Paragraph (2) of Subdivision (D) of Section 54956.9(B): Number of Cases: Two (2).
- CONFERENCE WITH LEGAL COUNSEL - EXISTING LITIGATION - Pursuant to Paragraph One (1) of Subdivision (d) of the Government Code Section 54956.9 Case Name: Diana Gunn. vs. West Valley Water District, Case No. CIVSB2117195.
- CONFERENCE WITH LEGAL COUNSEL - EXISTING LITIGATION - pursuant to Paragraph one (1) of Subdivision (d) of the Government Code Section 54956.9 Case Name: Patricia Romero vs. West Valley Water District, Case No. CIVDS2024402.
- CONFERENCE WITH LEGAL COUNSEL - EXISTING LITIGATION - Pursuant to Paragraph One (1) of Subdivision (d) of the Government Code Section 54956.9 Case Name: Nadia Loukeh. vs West Valley Water District, Case No. CIVSB2116242.
- CONFERENCE WITH LEGAL COUNSEL - PUBLIC EMPLOYEE APPOINTMENT - Pursuant to Government Code Section 54957, Title(s) Chief Financial Officer.
- CONFERENCE WITH LEGAL COUNSEL - PUBLIC EMPLOYEE APPOINTMENT - Pursuant to Government Code Section 54957, Title(s) Board Secretary.
- CLOSED SESSION PURSUANT TO GOVERNMENT CODE SECTION 54957 - Public Employee Performance Evaluation - General Counsel.

ADJOURN

DECLARATION OF POSTING:

I declare under penalty of perjury, that I am employed by the West Valley Water District and posted the foregoing Agenda at the District Offices on October 17, 2022.



Nancy Albitre, Acting Board Secretary

Please Note:

Material related to an item on this Agenda submitted to the Board after distribution of the agenda packet are available for public inspection in the District's office located at 855 W. Baseline, Rialto, during normal business hours. Also, such documents are available on the District's website at www.wvwd.org subject to staff's ability to post the documents before the meeting.

Pursuant to Government Code Section 54954.2(a), any request for a disability-related modification or accommodation, including auxiliary aids or services, in order to attend or participate in the above-agendized public meeting should be directed to the Acting Board Secretary, Nancy Albitre, at least 72 hours in advance of the meeting to ensure availability of the requested service or accommodation. Ms. Albitre may be contacted by telephone at (909) 875-1804 ext. 346, or in writing at the West Valley Water District, P.O. Box 920, Rialto, CA 92377-0920.



**BOARD OF DIRECTORS
STAFF REPORT**

DATE: October 20, 2022
TO: Board of Directors
FROM: Van Jew, Acting General Manager
SUBJECT: BUNKER HILL WELL SITE EVALUATION PH2

BACKGROUND:

The West Valley Water District (“District”) requested proposals from expert groundwater consultants (“Consultants”) to provide professional hydrogeological services related to performing a comprehensive well siting evaluation for Phase 2 of the Bunker Hill Well Siting Evaluation (“Project”). The District is interested in drilling and constructing new groundwater supply wells in the Bunker Hill Groundwater Basin to enhance groundwater production supply.

A comprehensive well site evaluation will focus on potential sites outside of the Management Zone Area (“MZA”) of the US EPA 2004 Consent Decree for the Newmark and Muscoy Groundwater Contamination Superfund Site. This evaluation is required to ensure any new groundwater production well maximizes production potential as well as meets water quality objectives. The comprehensive geological evaluation, designated Phase 2, will identify production well sites outside the MZA that have the highest probability of success in meeting the District’s water supply goals. Attached as **Exhibit A** is a copy of the MZA map. As part of the preliminary phase to this work, Phase 1 of the Bunker Hill Well Siting Evaluation identified potential well sites within the MZA and has been completed. In preparation of the well siting evaluation for Phase 2, the consultant will obtain and review all relevant geohydrologic data and other available background information regarding the well site areas included in Phase 1.

DISCUSSION:

District Staff posted the Request for Proposal (“RFP”) on PlanetBids and sent out the RFP to consulting firms who specialize in groundwater resource management. Two (2) consulting firms – Geoscience Support Services, Inc. (“Geoscience”) and Wood Rodgers submitted proposals in response to the RFP.

The written proposals were reviewed by a committee comprised of District Staff and were evaluated based on the following criteria:

- Past performance and qualifications of the proposal team members on similar projects.
- Familiarity with a company to handle all aspects of the work.
- Ability to complete the project within an expedited time frame.

- The proposed project approach, scope, manner, and thoroughness in which it is presented in the proposal.
- Firm's experience, staff availability, and stability.
- Consultant fees.

The proposal costs for professional hydrogeological services related to Bunker Hill well siting evaluation are shown below:

Consultant	Cost
Geoscience	\$32,567.00
Wood Rodgers	\$80,413.00

To determine the best value for the District, Staff first ensured that all proposals received met the minimum requirements in the scope of work by conducting a systematic proposal evaluation. Based on technical qualifications, overall evaluation, and costs, Staff concluded that Geoscience provided the best value for the District's needs. The firm's design approach, overall understanding of the project's goals, and the completion of Bunker Hill Well Siting Evaluation for Phase 1 further aided in the selection process for the RFP. Attached as **Exhibit B** is a copy of the proposal submitted by Geoscience.

FISCAL IMPACT:

The cost to provide the services for the Project as proposed by Geoscience is \$32,567.00. This item is included in the Fiscal Year 2022/23 Capital Improvement Budget under the W20001 Property Investigation for Bunker Hills Wells and Pump Station. Sufficient funds are available in the project budget to cover the cost.

STAFF RECOMMENDATION:

Staff recommends that to the Board of Directors to authorize entering into a contract with Geoscience in the amount of \$32,567.00 for the hydrogeological services for the Bunker Hill Well Siting Evaluation Project Phase 2.

Respectfully Submitted,

Van Jew

Van Jew, Acting General Manager

RMG:ls

ATTACHMENT(S):

1. Exhibit A - Management Zones Area Map
2. Exhibit B - Proposal Submitted by Geoscience

MEETING HISTORY:

10/12/22 Engineering, Operations and Planning Committee REFERRED TO BOARD

EXHIBIT A

Exhibit A - Modification

Management of the US EPA 2004 Consent Decree for the Newmark & Muscovy Groundwater Contamination Superfund Site

5.1.a

0 2,500 5,000 7,500 10,000 12,500 Feet

Raymond Brown December 21, 2004



The San Bernardino Valley Municipal Water District has prepared and uses this information for its own purposes and it is not intended for, nor may it be suitable for, use by others. The information is provided "as is". Further information may be obtained by contacting the GIS Department by calling (909) 387-9275.

¹ As provided by the San Bernardino Municipal Water Department on December 10, 2004*. Plume is an approximation based on PCE concentrations in excess of 5 µg/l from 2002/2003 monitoring data.

² Per the Western-San Bernardino Watermaster: Western Municipal Water District et al. vs. East San Bernardino County Water District et al.; Case No. 78426 Superior Court County of Riverside.

* Management Zones were modified to exclude the City of Colton.

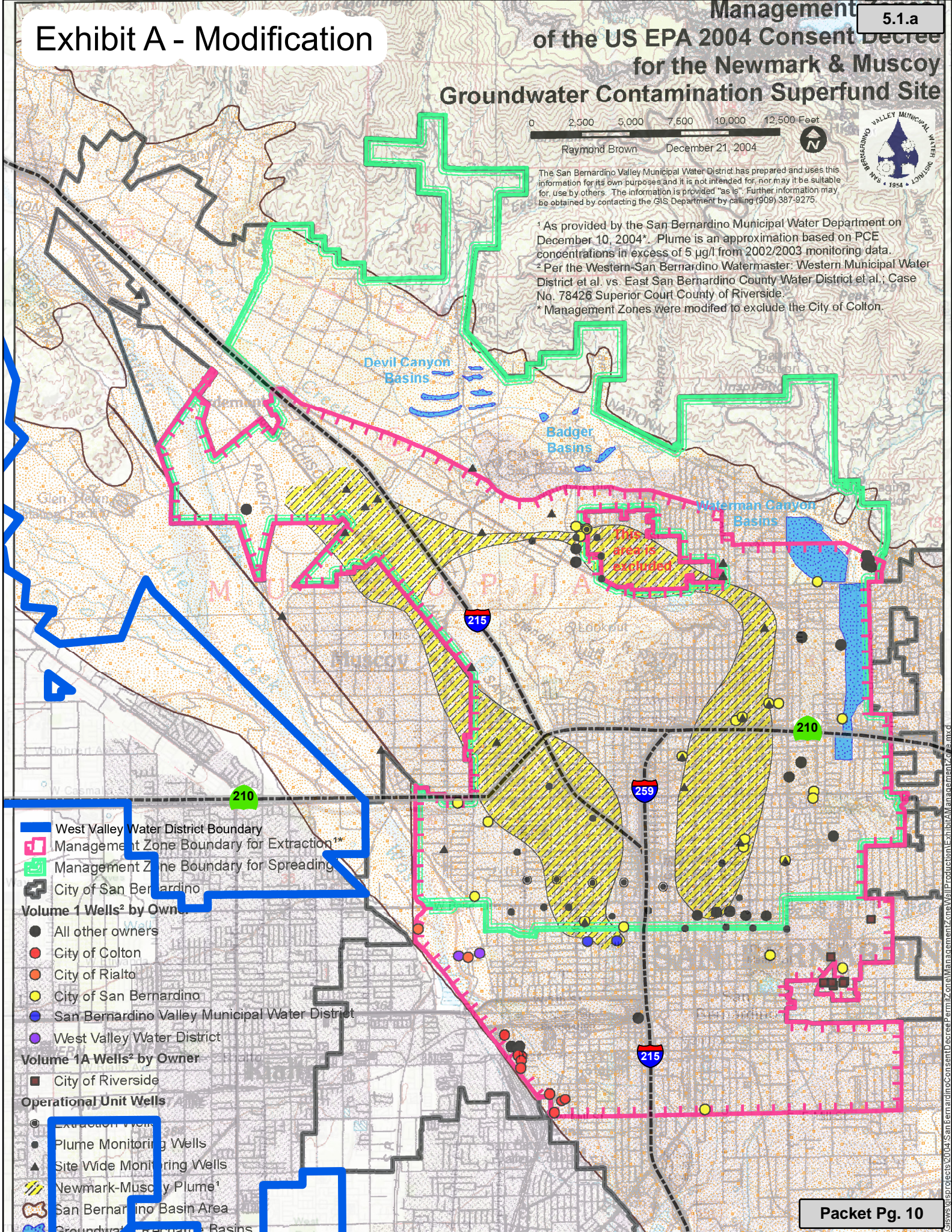

- West Valley Water District Boundary
- Management Zone Boundary for Extraction**
- Management Zone Boundary for Spreading
- City of San Bernardino
- Volume 1 Wells² by Owner**
 - All other owners
 - City of Colton
 - City of Rialto
 - City of San Bernardino
 - San Bernardino Valley Municipal Water District
 - West Valley Water District
- Volume 1A Wells² by Owner**
 - City of Riverside
- Operational Unit Wells**
 - Extraction Wells
 - Plume Monitoring Wells
 - Site Wide Monitoring Wells
 - Newmark-Muscovy Plume¹
 - San Bernardino Basin Area
 - Groundwater Recharge Basins

W:\projects\2004\SanBernardinoConsentDecree\emissions\ManagementZone\ExhibitA\ManagementZone.mxd

EXHIBIT B

GEOSCIENCE

5.1.b

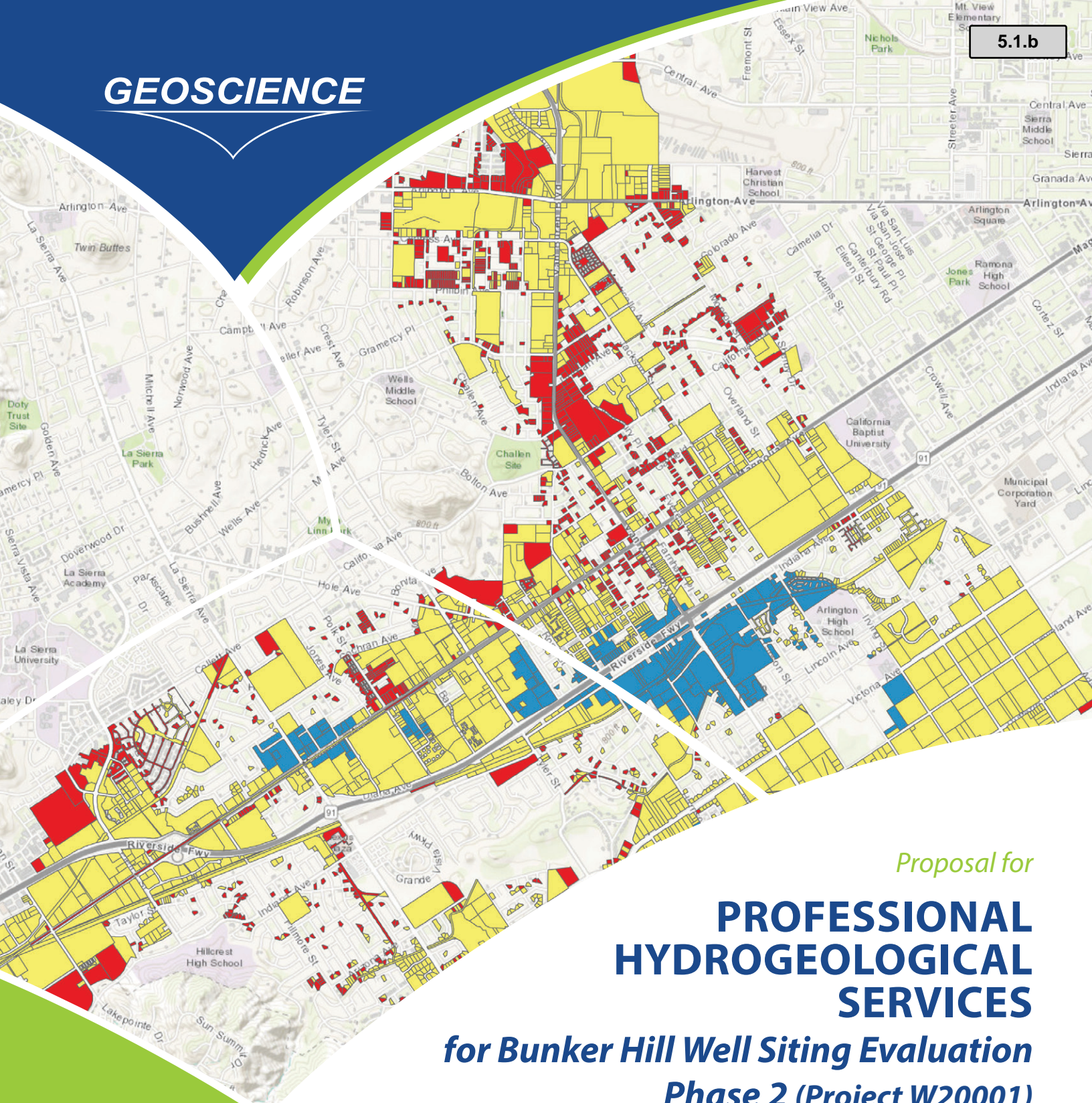

Proposal for

PROFESSIONAL HYDROGEOLOGICAL SERVICES

***for Bunker Hill Well Siting Evaluation
Phase 2 (Project W20001)***

Presented to:

West Valley Water District

September 29, 2022

main office

160 Via Verde, Suite 150, San Dimas, CA 91773

main | 909.451.6650

gsswater.com

Packet Pg. 12

Contents

COVER LETTER..... 1

BACKGROUND ON FIRM 2

STATEMENT OF UNDERSTANDING & APPROACH 15

SCOPE OF WORK 16

PROJECT SCHEDULE 20

REFERENCES..... 21

ADDITIONAL INFORMATION..... 23

COST ESTIMATES OF CONSULTING FEE..... SEPARATE FILE

September 29, 2022

The First Name in Groundwater

Al Robles, Purchasing Supervisor
 West Valley Water District
 855 W. Baseline Rd.
 Rialto, CA 92376

RE: Proposal to Provide Professional Hydrogeological Services Related to the Bunker Hill Well Siting Evaluation Phase 2

Dear Mr. Robles,

Geoscience Support Services, Inc. (Geoscience) is pleased to submit this proposal to West Valley Water District (WVWD) to provide professional hydrogeological services for Phase 2 of a comprehensive well site evaluation that identifies potential production well sites outside of WVWD’s Management Zone Area, that have the highest probability of success in meeting district water supply goals. WVWD requires a cost-efficient, knowledgeable, and reliable team to provide this phase of the siting evaluation. Since Geoscience prepared the Phase 1 of this siting evaluation, you know that we utilize an internally developed and well-established process for well siting, that includes the use of our in-house GIS-based analysis tool. As evidence of the success of our typical approach, successful supply and production wells have been completed for more than 100 wells over the past decade. As such, we have closely considered the needs of your project and have assembled a team and approach that will help you successfully complete this project on schedule. Our team offers WVWD the following benefits:

- **A qualified and experienced team to provide comprehensive hydrogeological services**
 For more than 40 years, Geoscience has focused solely on groundwater consulting and production well design and rehabilitation. We have a long history in the industry having completed more than 1,000 well projects, including well siting, design, development, and groundwater modeling and studies. Additionally, as our assigned project manager I have worked on and supported more than 350 well projects and provided third-party review. *Both the extensive experience of our project manager and project team, combined with our knowledge and familiarity of the basin, will provide you with a comprehensive production well siting report to help you meet your water supply needs.*
- **The use of our in-house GIS-based analysis tool can provide a rapid assessment of many of your project criteria saving considerable time comparing potential sites**
 A tool commonly utilized by Geoscience to accomplish well site evaluation studies combines static suitability factors with a framework to incorporate dynamic model results, allowing all potential sites to be evaluated at once. *Our customizable tool allow us to save a sizable amount of time comparing potential sites allowing for additional alternative scenarios to be considered and will help you make better-informed decisions for your future water supply.*
- **Using a proven project approach will help deliver a successful project**
 Our team members have conducted numerous well siting studies for many of our current clients and we will continue using the same approach that has successfully delivered numerous well development projects. *Because we have successfully completed more than 100 production and supply well siting reports, designs, construction, and development projects in the last decade, we can provide more certainty on a successful project outcome.*
- **Our knowledge of the local area can improve project efficiency and reduce long-term costs**
 At Geoscience, we focus on getting it right the first time. Our familiarity with the local basins and recent, relevant experience enables us to eliminate the learning curve, improving project efficiency. *Our knowledge of the local groundwater basins, our track record of successfully providing identical services, and our focus on long-term cost savings will help you keep your project on schedule and reduce long term costs.*

We are committed to continuing our relationship with WVWD and the experience acquired during our history of working with you and other California water districts and agencies allows us to provide the hydrogeological capabilities that you require to achieve your goals. If you have any questions regarding our submittal or need any additional information, please contact me at (909) 667-4057, or via email at twatkins@geoscience-water.com.

Regards,

Terry Watkins, PG, CHG
 Project Manager

P.O. Box 220
 Claremont, CA 91711

BACKGROUND ON FIRM

Geoscience Support Services Inc. (Geoscience) is a leading groundwater consulting firm, working with water utilities, government agencies, and private industry to overcome their most complex challenges in developing, managing, and preserving groundwater resources.

Founded in 1978 by Dr. Dennis Williams, Geoscience was one of the first hydrogeology firms in California established to provide consulting services to the groundwater industry. Our firm is a trusted advisor to industry professionals and stakeholders—delivering solutions to groundwater supply, development, management, and protection challenges that meet the changing needs of our clients.

For more than 43 years, Geoscience has been serving the water districts and municipalities of Southern California, performing work in nearly every basin, and completing more than 2,000 groundwater projects. Geoscience is one of the first, and today is one of the largest, groundwater-focused consultancies in the state. We are world renowned for well expertise, having helped to develop the national standards for well design and completed work on more than 1,000 wells in Southern California and worldwide.

OUR QUALIFICATIONS

Well siting, design and supervision of construction are part of our day-to-day business at Geoscience. Our expertise comes from practical, hands-on experience designing and working on hundreds of municipal, high capacity water wells. We also site, design, and supervise construction of injection, extraction, and irrigation supply wells for municipalities, irrigation districts, and other water purveyors.

Geoscience handles all phases of well projects—from evaluating geohydrologic data and developing and calibrating groundwater flow models for well siting, to borehole drilling and design and construction supervision of new wells. Our well design methods, quality of construction supervision, and experience have led to our wells being known for their high efficiency, low sand

GEOSCIENCE *by the Numbers*

Company Headquarters:

160 Via Verde, Suite 150
San Dimas, CA 91773

P: 909.451.6650

E: email@geoscience-water.com

Branch Offices:

Tucson, AZ
Modesto, CA

Contact:

Terry Watkins, PG, CHG

P: 909.667.4057

E: twatkins@geoscience-water.com

Type of Organization: Corporation (CA),
Small Business Certified

Number of years in business: 43

Number of staff: 28

Company Owners/Officers:

- ◆ Dennis Williams, PhD, PG, CHG and Virginia Williams - Owners
- ◆ Dennis Williams - President
- ◆ Mark Williams, PhD, PE - CEO, CFO, and Secretary

MORE THAN **1,000**

Wells developed by Geoscience

Demonstrated ability to successfully design your project based on our experience with hundreds of similar projects

MORE THAN **350**

Wells designed and installed by our assigned project manager

Our project manager's extensive experience provides you with unparalleled expertise in well development and a successful project.

production, and long lifetime with minimal maintenance—helping clients meet their goals of installing wells that produce the most water with the lowest lifecycle costs.

The Geoscience team is also often called upon to look into increasing efficiencies in water production and troubleshoot and test existing wells for water quality and other issues. We work closely with the professionals at our public and private clients to make sure our client’s objectives are met, and are well versed in project management and stakeholder communications.

Our extensive experience in all phases of water well projects has earned Geoscience a reputation as a leader in the groundwater industry. Members of our staff serve on national committees, including the Well Standards Committee of the American Water Works Association (AWWA), among others. Members of the Geoscience team are frequently sought after speakers on topics related to well siting, design, construction, testing, and maintenance. For more than four decades, Geoscience has focused solely on groundwater wells and consulting, resulting in a team with extensive experience in well development and inspection. Our assigned team has more than 100 years of combined well siting, development, and construction experience, and have recently completed seven new production wells in various counties throughout Southern California.

We also specialize in groundwater modeling and studies, and well rehabilitation. With this experience, we are able to leverage Geoscience’s modeling knowledge to provide additional information to help you accurately assess potential water quality issues on potential well sites.

ASSIGNED STAFF

Terry Watkins, PG, CHG will serve as our assigned project manager. He has served as the project manager and senior geohydrologist in the completion of more than 350 well projects, including production wells, monitoring wells, injection wells, and extraction wells. Terry

will be supported by two technical advisors, Brian Villalobos, PG, CHG, CEG and Chris Coppinger, PG, CHG. Each have experience completing production and supply wells in similar conditions. Brian and Chris are available to provide backup support to Terry if needed.

The organization chart below lists our assigned staff and their role on this project. We have also included detailed biographies and a listing of our project team’s relevant experience on the following pages. In addition, personnel assigned to this project will not be changed for the duration of the project without the advance written approval of WVWD. Detailed key team resumes are available at the end of this section.

KEY TEAM MEMBERS

Terry Watkins, PG, CHG

Project Manager



Terry has more than 18 years of experience in a variety of groundwater projects, including geohydrologic investigations, groundwater quality studies, artificial recharge projects, site feasibility and test drilling programs, sea water desalination programs, in addition to water well construction

Proposed Team Organization Chart

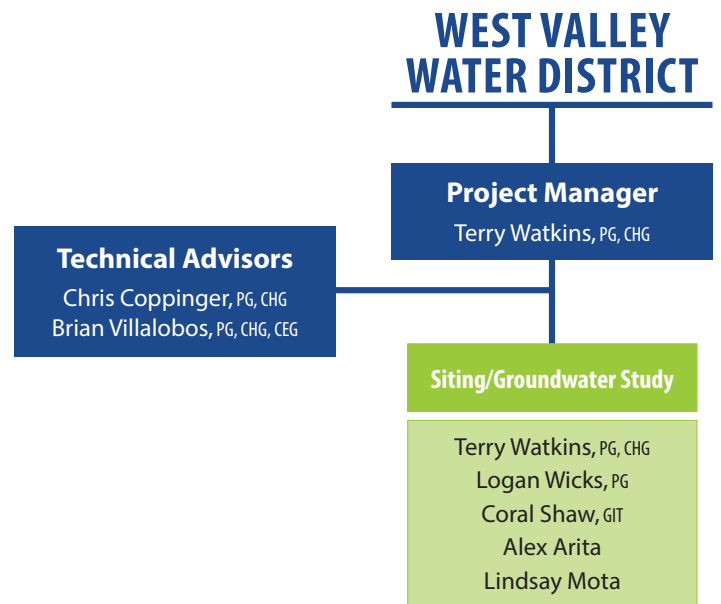

supervision and management. Terry has completed more than 350 well projects over the course of his career. He is currently a Senior Geohydrologist at Geoscience and manages our well construction group, overseeing project aspects ranging from site evaluation and selection, preliminary well design, development of technical specifications, final well design, aquifer pump test analysis, development of well rehabilitation programs, and providing construction management. Terry has performed project management and well construction management and supervision on several multi-well projects throughout California including municipal water supply wells, ASR wells, injection wells, and monitoring wells.

Relevant Experience:

- **Bunker Hill Well Siting Evaluation Phase 1, West Valley Water District:** Terry led efforts to site a production well in an area near known plumes, other production wells, river channel, and a highly industrial populated area. He and his team used an **in-house GIS analysis tool** to help locate potential sites suitable for up to two wells near their future mainline.
- **Well Site Evaluation and Construction of New Miragrind Well, Three Valley Municipal Water District:** Terry oversaw and managed a detailed site assessment and evaluation study with the purpose of identifying potential location for future groundwater wells that would maximize production and not require treatment. This task was performed using **in-house GIS based software** to identify potential locations. Once completed, Terry was the project manager for a new potable supply well.
- **Well No. 28, City of Lakewood:** Terry was the project manager for a new well constructed for the City of Lakewood, designated Well No. 28. The well was completed under budget, ahead of schedule, and exceeded production expectations, producing 2,500 gpm with a specific capacity over 100 gmp/ft.

Brian Villalobos, PG, CHG, CEG **Technical Advisor**



Brian has more than 32 years of professional experience in geohydrology and environmental geology throughout the Southern California region. His specific areas

of expertise are in hydrogeologic investigations to support indirect potable reuse, groundwater recharge, and groundwater basin characterization projects. He has studied and modeled groundwater basins across the State and has led efforts to develop studies and reports including, monitoring well networks, groundwater recharge projects, sustainable yield, water budgets, and more. He currently serves several cities and water districts to develop and assess groundwater recharge projects, including the City of Oceanside, Elsinore Valley Municipal Water District, San Bernardino Valley Municipal Water District, Yucaipa Valley Water District, and others. Brian has also supported 20 groundwater related litigation cases serving as either the lead technical advisor or in a support role.

Relevant Experience:

- **Hydrogeological Investigation of the Warm Springs Subbasin, Elsinore Valley Municipal Water District:** Brian led a hydrogeologic investigation to quantify the groundwater storage and safe yield of the Warm Springs Subbasin, estimate yield for future municipal supply well, determine water quality in the subbasin, identify needed potable water conveyance infrastructure, and plan environmental and permitting requirements.
- **Evaluation of Potential Locations for Ground Water Recharge at the East and West Dam Sites, Diamond Valley Lake, Riverside County:** Brian assessed water quality and water level trends and other considerations to evaluate impacts from proposed recharge scenarios.

Chris Coppinger, PG, CHG **Technical Advisor**



Chris has more than 18 years of professional experience on more than 50 municipal supply wells and has completed more than 150 well field assessments. As a senior Geohydrologist for Geoscience, Chris provides oversight for multiple projects involving well construction and deconstruction, design and construction oversight, permitting and working with county and state agencies, interpreting pump tests, drilling process and fluids, analysis in well productions, and well rehabilitation. As a project manager, Chris pulls from his depth of knowledge to recognize and mitigate

potential project issues early in the project. He is experienced in interacting with all levels of management and professionals to help his team and external contractors to keep the project on schedule and within budget. Chris excels at task and time tracking and how it affects the project's overall success. He has helped many clients find long-term solutions that help reduce future maintenance and operational costs well after the project is completed.

Relevant Experience:

- **North Torrance Wellfield, Well Nos. 10 & 11, City of Torrance:** Chris was the Project Manager for design-build services for Wells No. 10 and 11 in the North Torrance Wellfield (NTWF), as well as demolition services for Well No. 6. Our team provided technical specifications and preliminary design for review and approval by the City.
- **Groundwater Supply Study, California Water Service Company:** Chris developed a strategy to maximize groundwater production to fully utilize pumping allotment across two adjudicated basins. He compiled and reviewed historical pumping and water level data in district wells, and located data from other nearby wells. Chris then developed rehabilitation schedules, long term average flow rates, and provided areas to target for future well siting.
- **Well Rehabilitation and Groundwater Monitoring Program, City of Riverside:** Chris managed efforts to compile and review historical well data for 60 potable water supply wells owned and operated by the city. The project developed a well ranking system to prioritize well rehabilitation and repair. To complete the assessment, Chris reviewed video surveys, driller's logs, construction information, historical pumping, performance, ground water elevations, and past rehabilitation/redevelopment measures. Chris helped develop a priority ranking matrix for well rehabilitations/replacement that included the well's estimated remaining useful life, and estimated rehabilitation costs over five, ten and twenty years. At the conclusion of the review Chris developed presentations and attended project workshops to present and discuss findings to key project personnel.

Logan Wicks, PG

Siting Study Project Geohydrologist



Logan has more than 15 years of professional experience on more than 27 municipal direct or alternative supply wells and has completed more than 70 well field assessments and groundwater studies. His experience includes many different types of projects, such as geohydrologic investigations, groundwater quality studies, artificial recharge projects, water well test drilling programs, sea water desalination programs, and the management and supervision of water well projects including: siting, design, aquifer pumping test analyses and well construction. He has managed numerous well projects including water supply wells, injection wells, and monitoring wells. He has performed various aquifer pump tests analyses and help developed water quality sampling protocols including specialized depth specific sampling and analysis. He is also part of a team developing new methodologies for collecting real time flow and water quality data for better and more accurate well design and quality control.

Relevant Experience:

- **Bunker Hill Well Siting Evaluation Phase 1, West Valley Water District:** Logan assisted with efforts to site a production well in an area near known plumes, other production wells, river channel, and a highly industrial populated area. An **in-house GIS analysis tool** was used to help locate potential sites suitable for up to two wells near their future mainline.
- **New Well No. 28, City of Lakewood:** Logan helped lead efforts to develop the technical specifications for the City of Lakewood Well 28 Project. He drafted the preliminary design and construction sheets for the design phase.
- **Miragrand Well, Three Valleys Municipal Water District:** Logan conducted a detailed site assessment and evaluation study with the purpose of identifying potential location for future groundwater wells that would maximize production and not require treatment. This task was performed using **in-house GIS based software** to identify potential locations. Once completed, a new potable supply well was designed, developed, and constructed.

Coral Shaw, GIT**Siting Study Field Support**

Coral has more than eight years of geohydrological experience in water supply well development and construction. Coral has performed well construction inspection for tasks such as pilot borehole drilling and reaming, casing inspection and installation, air lifting and swabbing, development by pumping, and down-hole video logging. She has also performed various pumping test analyses, including large scale pumping tests and water quality sample collection. In addition, Coral prepares well designs based on data collected during the drilling process, provided final pump design recommendations, and final summary reports.

Relevant Experience:

- **Ph. 3 Well II-10 & II-11, Chino Basin Desalter Authority:** Coral developed pre-bid meeting notes, reviewed technical specifications, and bid contracts. She also provided on-site observation during constant rate testing and pump development.
- **Miragrاند Well, Three Valley Municipal Water District:** Coral support design efforts and was the lead inspector for a new potable supply well. This project provided unique challenges in that it is in an affluent residential community whose neighbors do not want construction activity to disturb them. Close coordination and additional noise mitigation procedures were required to complete this work.
- **New Well No. 28, City of Lakewood:** Coral supported efforts to design and construct a new production well for the City. She also led coordination efforts with the City and the drilling contractor, and observed pilot and conductor borehole drilling and casing installation.
- **Groundwater Well Evaluation and Rehabilitation, City of Pomona:** Coral supported efforts to evaluate the city's existing well network and develop a rehabilitation ranking plan to improve groundwater productions. To support the project, Coral collected and analyzed available well data and helped develop a well criteria matrix to prioritize well rehabilitation activities.

Alex Arita**Siting Study Field Support**

Alex has five years of experience and has been involved in many different types of well projects, well assessments, groundwater level monitoring, water well test drilling programs, well rehabilitation, and new construction. He performs field supervision during well design and construction, water quality sampling and analyses, and well rehabilitation/redevelopment.

Relevant Experience:

- **Phase II Characterization, West Valley Water District (WVWD):** Our team helped West Valley Water District to evaluate the production potential and water quality several potential well sites. After the sites were acquired, Alex supported field rehabilitation and helped optimize water production for the wells. He supported well development, oversaw aquifer pump tests, spinner survey, and performed composite and depth-specific groundwater quality sampling. Alex then verified production data and made recommendations to improve well production and efficiency.
- **Miragrاند Well, Three Valley Municipal Water District:** Alex supported the permitting efforts to design and permit a new production well. He developed the Drinking Water Source Assessment and Protection (DWSAP) documentation to calculate distance and transit times from potential contamination sources. Alex also calculated fixed radius and physical barrier effectiveness, generated shape files for capture zones, and developed K tables to rank potential risks.
- **Well No. 102, Rancho California Water District:** Alex completed comprehensive Drinking Water Source Assessment and Protection documentation for Well No. 102. Initially, the well was only contributing to the district's recycled water system. The types of tests conducted by Alex included: calculations for the fix radius and physical barrier effectiveness. He generated shape files for the capture zones, which identified the types of Possible Contaminating Activities (PCA) that occurred within the ground water protection areas surrounding the well. He also worked on K tables to rank PCA risks.

Terry Watkins, PG, CHG

Senior Geohydrologist / Project Manager



EDUCATION AND PROFESSIONAL REGISTRATIONS/ CERTIFICATIONS:

- ◆ BS, Geology, Cal Poly Pomona
- ◆ California Professional Geologist (No. 9046)
- ◆ Certified California Hydrogeologist (No. 1038)

Terry has more than 18 years of experience in a variety of groundwater projects, including geohydrologic investigations, groundwater quality studies, artificial recharge projects, site feasibility and test drilling programs, sea water desalination programs, in addition to water well construction supervision and management. Terry has completed more than 350 well projects over the course of his career. He is currently a Senior Geohydrologist at Geoscience and manages our well construction group, overseeing project aspects ranging from site evaluation and selection, preliminary well design, development of technical specifications, final well design, aquifer pump test analysis, development of well rehabilitation programs, and providing construction management. Terry has performed project management and well construction management and supervision on several multi-well projects throughout California including municipal water supply wells, ASR wells, injection wells, and monitoring wells.

SUMMARY OF EXPERIENCE:

West Valley Water District: Bunker Hill Well Siting Evaluation Phase I

Terry led efforts to site a production well in an area near known plumes, other production wells, river channel, and a highly industrial populated area. He and his team used an inhouse GIS analysis tool to help locate potential sites suitable for up to two wells near their future mainline.

West Valley Water District: Lytle Creek and Bloomington Area Preliminary Feasibility Study for Artificial Recharge

Terry was the project manager and oversaw two feasibility studies using the existing Rialto-Colton and Riverside-Arlington groundwater models to determine the benefits of artificial recharge using capture stormwater to district wells.

West Valley Water District: Rialto-Colton Monitoring Well

Terry was the project manager to drill, design, construct, and develop a 910 ft stainless steel monitoring well to monitor perchlorate migration.

Years of Experience: 18
Years with GEOSCIENCE: 16

KEY QUALIFICATIONS...

- ◆ Superior relationship with drillers —maximizing well capacity and performance.
- ◆ Experience with more than 350 well projects— no learning curve, can efficiently complete the project—potentially reducing schedule delays and cost overruns.



43+

Terry has provided well construction management services for more than 43 of our clients.



350+

Terry has completed more than 350 well projects.

Elsinore Valley Municipal Water District: Multiple Well Projects, On-Call Hydrogeology Services Contract

As part of this on-call contract, Terry led efforts involving several EVMWD wells, including evaluation of the Lincoln Well's suitability for rehabilitation, development of a rehabilitation plan, and construction management for the Joy Street Well, and evaluations and recommendations associated with the Diamond Well pump failure.

Elsinore Valley Municipal Water District: Near Term Water Supply Program

Terry led the efforts to develop rehabilitation plans and provide construction management services for the rehabilitation of five EVMWD wells, including Flagler Wells 2A and 3A, Cereal Wells 1 and 3, and the Terra Cotta Well. He also provided preliminary design, final design, construction management, and testing services during the construction of the two new Lee Lake Wells. He also provided peer review for construction and pump design recommendations for the Palomar Well.

City of South Pasadena: Rehabilitation of Wilson Well #2

Terry developed rehabilitation recommendations and contractor work plan to rehabilitate Wilson Well #2. As the project and construction manager, Terry oversaw well redevelopment and testing, and as a result of his efforts, doubled well production capability.

Bedford Coldwater: Monitoring Wells

Terry recently completed designs for two new monitoring wells to help a groundwater sustainability agency implement their groundwater sustainability plan. This work included oversight during well drilling, final design, and reporting.

Chino Basin Desalter Authority: Monitoring Wells

Terry provided field oversight and construction management for monitoring well installation. The wells were to support an inland desalting facility to monitor salt concentrations and provide data to plan for future desalter expansion.

Chino Basin Desalter Authority: CDA Wells II-10, II-11, and II-12

Terry oversaw the technical specifications, drilling, construction, design, development, and testing of three, 450-foot deep, large diameter, high capacity municipal production wells. The wells had initial production goals of 2,500 gpm, however once completed the wells produced more than 3,500 gpm.

City of Lakewood: Well No. 28

Terry was the project manager for a new well constructed for the City of Lakewood, designated Well No. 28. Tasks included in this work included preliminary design, development of contract documents, contractor bid support, construction management and field supervision, draft preliminary and final DWSAP documents, aquifer pump test analysis, and reporting. The well was completed under budget, ahead of schedule, and exceeded production expectations, producing 2,500 gpm with a specific capacity over 100 gmp/ft.

Three Valley Municipal Water District: Well Site Evaluation and Construction of New Miragrand Well

Terry oversaw and managed a detailed site assessment and evaluation study with the purpose of identifying potential location for future groundwater wells that would maximize production and not require treatment. This task was performed using in-house GIS based software to identify potential locations. Once completed, Terry was the project manager for a new potable supply well that was completed at the end of 2020. This project provided unique challenges in that it is in an affluent residential community whose neighbors do not want construction activity to disturb them. Close coordination and additional noise mitigation procedures were required to complete this work.

Stirling Airports International: Geohydrologic Evaluation of Potential Discharge Basins

Terry performed field supervision for exploratory borehole drilling and single-ring infiltrometer testing at the test site.

Brian Villalobos, PG, CHG, CEG

Principal Geohydrologist / Technical Advisor



EDUCATION AND PROFESSIONAL REGISTRATIONS/ CERTIFICATIONS:

- ◆ BS, Geology, California State University, Los Angeles
- ◆ California Professional Geologist (No. 4153)
- ◆ Certified California Hydrogeologist (No. 794)
- ◆ Certified California Engineering Geologist (No. 1298)

Brian has more than 32 years of professional experience in geohydrology and environmental geology throughout the Southern California region. His specific areas of expertise are in hydrogeologic investigations to support indirect potable reuse, groundwater recharge, and groundwater basin characterization projects. He has studied and modeled groundwater basins across the State and has led efforts to develop studies and reports including, monitoring well networks, groundwater recharge projects, sustainable yield, water budgets, and more. He currently serves several cities and water districts to develop and assess groundwater recharge projects, including the City of Oceanside, Elsinore Valley Municipal Water District, San Bernardino Valley Municipal Water District, Yucaipa Valley Water District, and others. Brian has also supported 20 groundwater related litigation cases serving as either the lead technical advisor or in a support role.

SUMMARY OF EXPERIENCE:

Elsinore Valley Municipal Water District: Hydrogeological Investigation of the Warm Springs Subbasin

Warm Springs Groundwater Subbasin is a small, sedimentary groundwater subbasin located within Elsinore Valley Municipal Water District’s service area. To meet long-term population growth and increasing water demand, the District is exploring options to develop water resources within the Warm Springs Subbasin. Brian led our team and to complete a hydrogeologic investigation to quantify the groundwater storage and safe yield of the Warm Springs Subbasin, estimate yield for future municipal supply well, determine water quality in the subbasin, identify needed potable water conveyance infrastructure, and plan environmental and permitting requirements.

Western Municipal Water District: Riverside-Arlington Basin Groundwater Sustainability Plan

Brian is leading efforts to develop a GSP for the Riverside-Arlington Basin. The Basin is classified by DWR as a medium-priority basin and is one of the district’s primary sources of local water supply. Brian and our team are working in conjunction with the district to complete all studies

Years of Experience: 32
Years with GEOSCIENCE: 14

KEY QUALIFICATIONS...

- ◆ More than 30 years of groundwater resource studies and reports
- ◆ Specializes in groundwater recharge and water reuse
- ◆ Certified Hydrogeologist and Engineering Geologist
- ◆ Experience supporting more than 20 groundwater-related litigation cases.



30+

Brian has more than 30 years of experience providing specialized groundwater resource studies and reports.

and investigations necessary to complete a compliant GSP. Specific activities include supporting grant administration and stakeholder engagement, assessing and developing a data management system, reviewing monitoring networks and providing recommendations, and defining the plan area.

Yucaipa Valley Water District: Oak Valley Town Center Recharge Project

Brian is leading efforts to complete a feasibility study for a recycled water recharge project. To complete the study, our team developed a focused groundwater model, a 3-D lithologic model, and developed a test infiltration basin.

Yucaipa Valley Water District: Recycled Water Use Evaluation using the Gateway Sub-basin Focused Groundwater Model

Brian managed efforts to develop a geologic and hydrologic conceptual model and a groundwater flow and solute transport model for a 10 square mile area of the Gateway sub-basin and portions of five additional sub-basins. The model is being used to evaluate potential movement of recycled water from the Wilson Creek Spreading Basin.

San Bernardino County: Active Recharge Project from Tributaries of the Santa Ana River

Brian led our team to develop a watershed model to estimate potential stormwater capture from 13 tributary Creeks to the Santa Ana River in the San Bernardino Valley. The project included preparing conceptual designs for stormwater capture facilities and estimating potential new conservation water added to the ground water system from urban run-off capture.

Castaic Lake Water Agency: Santa Clara River Valley Salt and Nutrient Management Plan

Brian led efforts to determine ambient water quality conditions and develop a plan to confirm that water management practices were consistent with the agency's water quality objectives. The completed plan provided a framework to protect groundwater and improve groundwater resource sustainability. Brian led our team to develop a monitoring plan, and evaluate the effect that proposed projects would have on groundwater quality.

Riverside County: Hydrogeologic Evaluation of the Riverside Aquifer Storage and Recovery Project

Brian identified available Santa Ana River surface flows to use in On-Channel and Off-Channel recharge basins and evaluated recharge impacts on the ground water surface.

Riverside County: Evaluation of Potential Locations for Ground Water Recharge at the East and West Dam Sites, Diamond Valley Lake

Brian assessed water quality and water level trends and other considerations to evaluate impacts from proposed recharge scenarios.

San Bernardino Valley Municipal Water District: Recharge Investigation of the Yucaipa Groundwater Basin

Brian led efforts to complete a hydrogeologic investigation at eleven potential sites within the Yucaipa Groundwater Basin for potential artificial recharge. Recommendations for subsequent phases of investigation were provided for each site.

San Bernardino Valley Municipal Water District and Partners: Determination of the Usable Capacity and Safe Yield for each Sub-basin within the Yucaipa Basin Area

Brian led efforts to reevaluate sub-basin boundaries in the Yucaipa Groundwater Basin to assess the "safe yield" and storage capacity of each sub-basin. He developed a watershed model of the Yucaipa Valley to determine water balance terms previously not calculated.

City of Moreno Valley: Groundwater Basin Assessment for the Box Springs Mutual Water Company Service Area Rezoning

Brian helped evaluate available long-term water supplies from the San Jacinto Groundwater Basin to support future City development plans.



Christopher Coppinger, PG, CHG

Senior Geohydrologist / Technical Advisor

EDUCATION AND PROFESSIONAL REGISTRATIONS/ CERTIFICATIONS:

- ◆ BS, Geology, College of William & Mary
- ◆ California Professional Geologist (No. 9093)
- ◆ Certified California Hydrogeologist (No. 1040)

Chris has more than 18 years of professional experience on more than 50 municipal supply wells and has completed more than 150 well field assessments. As a senior Geohydrologist for Geoscience, Chris provides oversight for multiple projects involving well construction and deconstruction, design and construction oversight, permitting and working with county and state agencies, interpreting pump tests, drilling process and fluids, analysis in well productions, and well rehabilitation. As a project manager, Chris pulls from his depth of knowledge to recognize and mitigate potential project issues early in the project. He is experienced in interacting with all levels of management and professionals to help his team and external contractors to keep the project on schedule and within budget. Chris excels at task and time tracking and how it affects the project's overall success. He has helped many clients find long-term solutions that help reduce future maintenance and operational costs well after the project is completed.

SUMMARY OF EXPERIENCE:

California Water Service Company: Groundwater Supply Study

Chris developed a strategy to maximize groundwater production to fully utilize pumping allotment across two adjudicated basins. He compiled and reviewed historical pumping and water level data in district wells, and located data from other nearby wells. Chris then developed rehabilitation schedules, long term average flow rates, and provided areas to target for future well siting.

Hillwood Properties/City of Riverside: Well Replacement Project

Chris served as project manager for the well replacement for Hillwood Properties. Three production wells were replaced for the City of Riverside as part of two land lease projects. Thirteen existing wells were destroyed as part of the effort. For both projects, Geoscience provided specifications, plans, and bid support, along with field services including logging, isolated aquifer zone testing, final well design, and aquifer testing. In one project,

Years of Experience: 18

Years with GEOSCIENCE: 17

KEY QUALIFICATIONS...

- ◆ More than 15 years of well design and inspection experience—increasing project efficiency
- ◆ Expertise in water supply, injection, banking, and monitoring wells—helping to identify and resolve issues
- ◆ Experience with projects that contain multiple wells—helping to manage different schedules and budgets, as well as identify project inefficiencies



15+

Chris has more than 15 years of experience designing and inspecting water supply wells.

production from the new wells exceeded design requirements by more than 50%. In the other project, Geoscience identified multiple constituents above MCL during isolated aquifer zone testing and provided support for determining a new location for the replacement well.

City of Torrance: North Torrance Wellfield, Well Nos. 10 & 11

Chris was the Project Manager for design-build services for Wells No. 10 and 11 in the North Torrance Wellfield (NTWF), as well as demolition services for Well No. 6. Geoscience previously provided design and construction services for NTWF Well No. 9, which replaced Well No. 6 in 2009. Our team provided technical specifications and preliminary design for review and approval by the City. NTWF Well No. 10 construction included the installation of the conductor casing and drilling and testing the pilot borehole conducted in 2009. The Well No. 10 pilot borehole was backfilled in 2009 pending the decision made by City of Torrance to ream the borehole and complete the Well No. 10 construction during 2019 to 2020. NTWF Well No. 11 construction included pilot borehole drilling, isolated aquifer zone testing, borehole reaming, well construction, well development and pump testing.

City of Riverside: Well Rehabilitation and Groundwater Monitoring Program

Chris managed efforts to compile and review historical well data for 60 potable water supply wells owned and operated by the city. The project developed a well ranking system to prioritize well rehabilitation and repair. To complete the assessment, Chris reviewed video surveys, driller's logs, construction information, historical pumping, performance, ground water elevations, and past rehabilitation/redevelopment measures. Chris helped develop a priority ranking matrix for well rehabilitations/replacement that included the well's estimated remaining useful life, and estimated rehabilitation costs over five, ten and twenty years. At the conclusion of the review Chris developed presentations and attended project workshops to present and discuss findings to key project personnel.

City of Riverside: 2015 Well Rehabilitation

Upon completion of the Well Rehabilitation and Groundwater Monitoring Program, the city selected 4 wells for rehabilitation. Chris led efforts to, repair, rehabilitate, and return to service, a well drilled in 1927. He also provided recommendations to modify existing technical specifications to allow needed repairs, and oversaw field inspection during repair. All wells were successfully rehabilitated with two achieving major increases in efficiency.

Rancho California Water District: Replacement of Nine Municipal Wells

As one of the Project Managers, Chris assisted in leading efforts to prepare large reports and plans to install nine new production wells that would replace failing supply wells. Since 2013, eight wells have been completed, one was abandoned due to water quality issues, the last two were completed early 2019. Our team provided well design, technical specifications, and helped the assigned district engineer to prepare bid packages. Our drilling phase work included zone testing, data analysis, and preparing multiple design options for water quality and production rates.

Orange County Water District: Alamitos Barrier Improvement Project

This project constructed 17 new injection wells, four (4) nested monitoring wells, and two (2) piezometers. The injection wells serve to increase the capacity and effectiveness of the existing seawater barrier system. Chris maintained effective control of project scope, schedule, and budget while providing construction management services.

Confidential Client: Deep Completion Monitoring Well Network

Chris worked closely with Orange County Water District and California Division of Oil Gas and Geothermal Resources to site, drill, and install deep (up to 1,400 ft) monitoring wells. The wells are currently monitored monthly to determine if water-flood injection stimulated oil production is affecting groundwater gradient and quality in the upper aquifers.

Logan Wicks, PG

Project Geohydrologist



EDUCATION AND PROFESSIONAL REGISTRATIONS/ CERTIFICATIONS:

- ◆ BS, Geology, Cal Poly Pomona
- ◆ BS, Biology, Cal Poly Pomona
- ◆ MS Geology, Cal Poly Pomona
- ◆ California Professional Geologist (No. 9580)

Logan has more than 15 years of professional experience on more than 27 municipal direct or alternative supply wells and has completed more than 70 well field assessments and groundwater studies. His experience includes many different types of projects, such as geohydrologic investigations, groundwater quality studies, artificial recharge projects, water well test drilling programs, sea water desalination programs, and the management and supervision of water well projects including: siting, design, aquifer pumping test analyses and well construction. He has managed numerous well projects including water supply wells, injection wells, and monitoring wells. He has performed various aquifer pump tests analyses and help developed water quality sampling protocols including specialized depth specific sampling and analysis. He is also part of a team developing new methodologies for collecting real time flow and water quality data for better and more accurate well design and quality control.

SUMMARY OF EXPERIENCE:

West Valley Water District: Bunker Hill Well Siting Evaluation Phase I

Logan assisted with efforts to site a production well in an area near known plumes, other production wells, river channel, and a highly industrial populated area. Our team used an inhouse GIS analysis tool to help locate potential sites suitable for up to two wells near their future mainline.

West Valley Water District: Sentinel Well 1 Construction

Logan performed site field supervision, field work, on site supervision during reaming, caliper logging, casing installation, and assisted with NPDES discharge requirements.

West Valley Water District: Quarterly Depth Specific Sampling

Logan procured and developed depth specific Snap Samplers in three (3) WVWD Wells. He then provided on site supervision for depth specific sampling and water quality analysis.

Years of Experience: 15
Years with GEOSCIENCE: 7

KEY QUALIFICATIONS...

- ◆ More than a decade of experience supporting the design of municipal supply wells
- ◆ Experience and familiarity with groundwater production and monitoring well installation— helping to maximize well production and efficiency
- ◆ Proficient in interpreting well pump tests and well productions analyses, and troubleshooting drilling issues

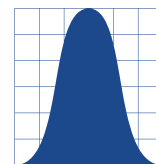

70+

Logan has completed more than 70 well field assessments and groundwater studies.

25+

Logan has supported the design of more than 25 municipal water supply wells.

City of Lakewood: New Well No. 28 Design and Technical Specifications

Logan helped lead efforts to develop the technical specifications for the City of Lakewood Well 28 Project. He drafted the preliminary design and construction sheets for the design phase.

City of South Pasadena: Rehabilitation of Wilson Well #2

Logan reviewed and evaluated video survey, production and pumping performance, hydrographs, water quality data, and side wall scraping results for Wilson Well #2. He helped prepare technical specifications for well rehabilitation, which included: cleaning of well casing and screen by brushing, applying dispersing agents, airlifting and swabbing, pumping and surging, aquifer pump tests, flowmeter survey, post-development video survey, and final well disinfection.

Elsinore Valley Municipal Water District: Multiple Projects

As part of an on-call contract, Logan led field efforts to rehabilitate six existing wells ranging in depth from 105 ft to 1,700 ft. Our team performed an initial site assessment, developed well designs, and oversaw production well construction.

Rancho California Water District: Replacement of Nine Municipal Wells

Logan assisted in leading efforts to prepare large reports and plans to install nine new production wells that would replace failing supply wells. Since 2013, eight wells have been completed, one was abandoned due to water quality issues, the last two were completed early 2019. Our team provided well design, technical specifications, and helped the assigned district engineer to prepare bid packages. Our drilling phase work included zone testing, data analysis, and preparing multiple design options for water quality and production rates.

Imperial Irrigation District: Monitoring Wells 1 & 2

Logan provided onsite well construction observation and data analysis. He helped develop the final well design, pump design and water quality analysis.

Chino Basin Desalter Authority: CDA Monitoring Well

Logan oversaw technical specifications, drilling, construction, design, development, and testing of 500-foot deep, monitoring well. The well will be used to monitor groundwater quality for a near-by treatment facility well field.

City of Huntington Beach: Well 1 Replacement

Logan performed well destruction and replacement for the City of Huntington Beach. He supported design efforts for well casing, screen, filter pack, and annular seal. During construction, he attended field meetings and worked with the contractor to inspect conductor bore hole drilling, casing installation, and the sanitary seal. He also sampled and logged soil cuttings, inspected aquifer zone testing for yield and water quality, and performed mechanical grading analyses. Once constructed, Logan inspected final development by pumping and surging and aquifer pumping tests.

Pico Water District: Well Number 11

Logan oversaw efforts to drafted technical plans and specifications, perform contractor bid assistance, and support permitting with regulatory agencies. Site selection for the project was challenging because of economic feasibility considerations. Working with the district Logan and our team successfully found solutions to integrate the new well into the existing system and meet the project completion dates and production goals set for early 2018.

Bellflower-Somerset Mutual Water Company: Leahy Avenue Well

Due to permitting issues this project was delayed for several years, Logan helped manage schedule and budget to get the project back on track and completed. The project successfully met the new schedule and budget and produces more than 3,500 gpm, with a specific capacity of 60 gpm/ft—meeting and surpassing project goals.

STATEMENT OF UNDERSTANDING & APPROACH

PROJECT UNDERSTANDING

West Valley Water District (WVWD) provides water service to thousands of people throughout Southwestern San Bernardino County and a small part of Northern Riverside County. In order to bolster its groundwater supply and diminish reliance from imported water sources, WVWD wishes to develop additional assets in the Bunker Hill Groundwater Subbasin of the Upper Santa Ana Valley Groundwater Basin which underlies the San Bernardino Valley. The Bunker Hill Groundwater Subbasin contains some of the most productive and prolific groundwater aquifers within the Upper Santa Ana Groundwater Basin. However, groundwater contamination and over pumping is of concern. In order to drill and construct new groundwater wells that maximize production potential while meeting water quality objectives, WVWD wishes to perform a comprehensive well site evaluation to identify the most advantageous locations in the Bunker Hill Subbasin. This evaluation, designated Phase II, will focus on potential sites outside of the Management Zone of the US EPA 2004 Consent Decree for the Newmark and Muscoy Groundwater Contamination Superfund Site. Candidate sites will meet the WVWD

desired production, be of acceptable water quality, and minimize interference with existing wells.

PRIMARY METHODOLOGY

One of the primary tools commonly utilized by Geoscience to accomplish well site evaluation studies is our geographical information system (GIS) based analysis tool. This tool allows Geoscience to rapidly assess many of the criterion necessary when evaluating potential sites. By combining static suitability factors (such as depth to bedrock, parcel zoning, and distance from infrastructure) with a solid framework to incorporate dynamic model results (such as recharge and extraction volumes, travel times, and saturated thickness), all of your potential sites can be evaluated at once. In addition, our GIS tool is coupled with model input parameters and scenario results of the Bunker Hill groundwater model previously developed by Geoscience.

This method saves a significant amount of time compared to considering potential sites on a parcel-by-parcel basis, which will enable you to consider more alternative scenarios and make better-informed decisions in the siting process. This approach is well-suited for a project such as this, where a relatively large area is being considered.

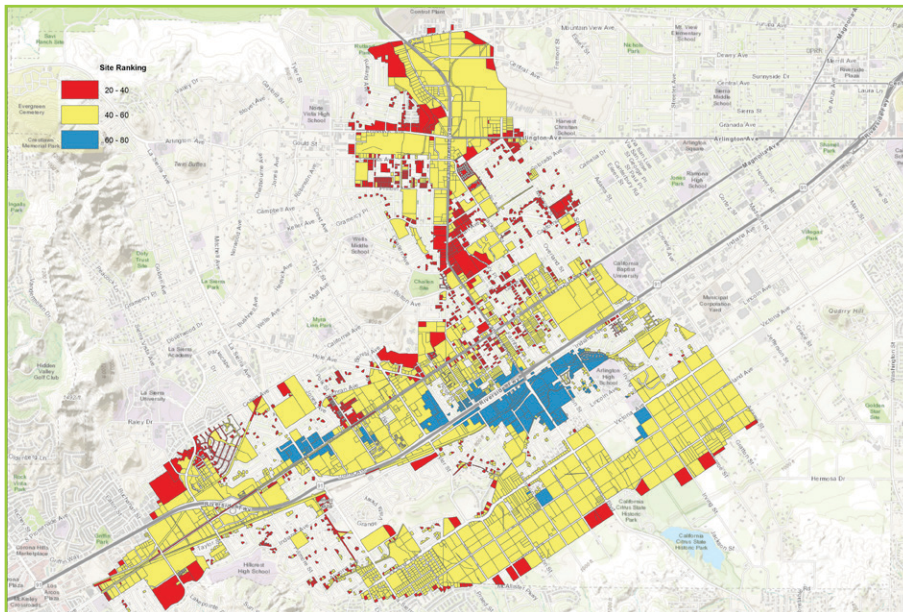

GIS Site Suitability: The example heat map on the left illustrates the most suitable well sites (shown in blue) and least favorable locations (shown in red).

SCOPE OF WORK

TASK 1. PROJECT MANAGEMENT & MEETINGS

1.1. Project Management

Effective control of a project's scope, schedule, and budget is fundamental to achieving a quality project. Our Project Team knows that understanding and managing the interrelationship of these three elements largely determines the project's success with respect to budget. Scope creep increases cost and produces delay. Delays increase costs and cause critical milestones to be missed. Geoscience understands these issues and has demonstrated ability to organize tasks, manage level of effort, develop and monitor critical-path schedules, and compare actual costs to planned costs at key milestones. By using these organizational techniques as well as good communication and coordination, a quality, on-time, and on-schedule project is ensured.

Geoscience will provide project management services throughout the entire project to ensure that all aspects are carried out in a proper and efficient manner. Project management activities will include (but not necessarily be limited to) coordination and correspondence with WVWD, project schedule updates, project budget monitoring, project status updates, and quality control and assurance. This task will also include availability to assist with any unforeseen issues which may arise throughout the course of the project.

1.2. Project Meetings

The primary objective of the project kick-off meeting will be to meet face-to-face with key project individuals from WVWD to make sure that everyone understands the intent, objectives, tasks, budgets, schedules, milestones, and deliverables of this project. The kick-off meeting also identifies any individuals outside of Geoscience that may be responsible for implementing any part of the work. This meeting provides a forum for discussion of critical path tasks, such as data collection, such that those tasks can be efficiently expedited.

The Geoscience Project Manager will review the study area and generally assess existing conditions and data requirements prior to attending the kick-off meeting. Other objectives of the kick-off meeting include (but are not necessarily limited to):

- ◆ Clarification of key issues for the project,
- ◆ Clarification and refinement of the scope of work based on the key issues,
- ◆ Clarification of the data needs to address the scope of work,
- ◆ Discussion of the project schedule.

A request for additional geohydrologic data and information not currently in Geoscience's database will be submitted and discussed at the kick-off meeting.

Following the Data review and processing (Task 2.1) Geoscience will issue DRAFT potential site location map and preliminary evaluation matrix. Geoscience will attend one (1) meeting with WVWD personnel to review and refine the potential site list, evaluation matrix, and weighting of each criteria. This meeting will establish the final potential sites and the criteria by which they shall be evaluated.

Finally, following submittal of the FINAL well site evaluation report, Geoscience will prepare for and participate in one (1) meeting with WVWD personnel to present the findings and to answer any questions that may arise.

TASK 2. WELL SITE EVALUATION

2.1. Data Collection and Processing

In preparation of the well siting evaluation, Geoscience will obtain and review all relevant geohydrologic data and other available background information regarding the well site areas. Key criteria for evaluating potential well sites include:

- ◆ Ability of aquifers to yield sufficient quantities of groundwater to meet WVWD's objectives,
- ◆ Production of groundwater quality that is acceptable to WVWD's standards,

- Minimization of potential pumping interference with nearby existing wells,
- Avoidance of excessive groundwater level drawdown and potential adverse environmental impacts to nearby wells,
- Compliance with regulatory requirements for distance from sewer lines or other utilities,
- Proximity to existing WVWD infrastructure for conveyance and treatment of water,
- Availability of undeveloped property for construction.

Geoscience has a long history of working within the Bunker Hill Groundwater Subbasin, and in the Upper Santa Ana Groundwater Basin as a whole, and has a thorough understanding of the geohydrology and maintains an extensive in-house well database. As part of the recently completed integrated Santa Ana River Model, we have compiled a comprehensive geohydrologic data base. In addition, a 3D lithologic model was developed using geophysical logs from for than 400 wells in the Bunker Hill Groundwater Subbasin. This data will be utilized for the construction of a GIS based analysis tool which will allow for the evaluation of multiple site.

Nevertheless, it will be necessary to update our database with the latest geohydrologic and well operational information. This data includes, but is not necessarily limited to, the following:

- Construction details for production wells drilled within WVWD’s boundary;
- Lithologic and geophysical logs from existing wells and any other exploratory boreholes that have been drilled in the area;
- All relevant pumping and aquifer test data, including well performance characteristics;
- Updated historical ground water elevation data;
- Updated ground water production histories; and
- Updated ground water quality information (depth-specific, if available).

2.2. Well Siting Evaluation

The purpose of the well siting evaluation is to provide WVWD with a comprehensive geohydrological evaluation that identifies production well sites that have the highest probability of success in meeting WVWD’s water supply goals.

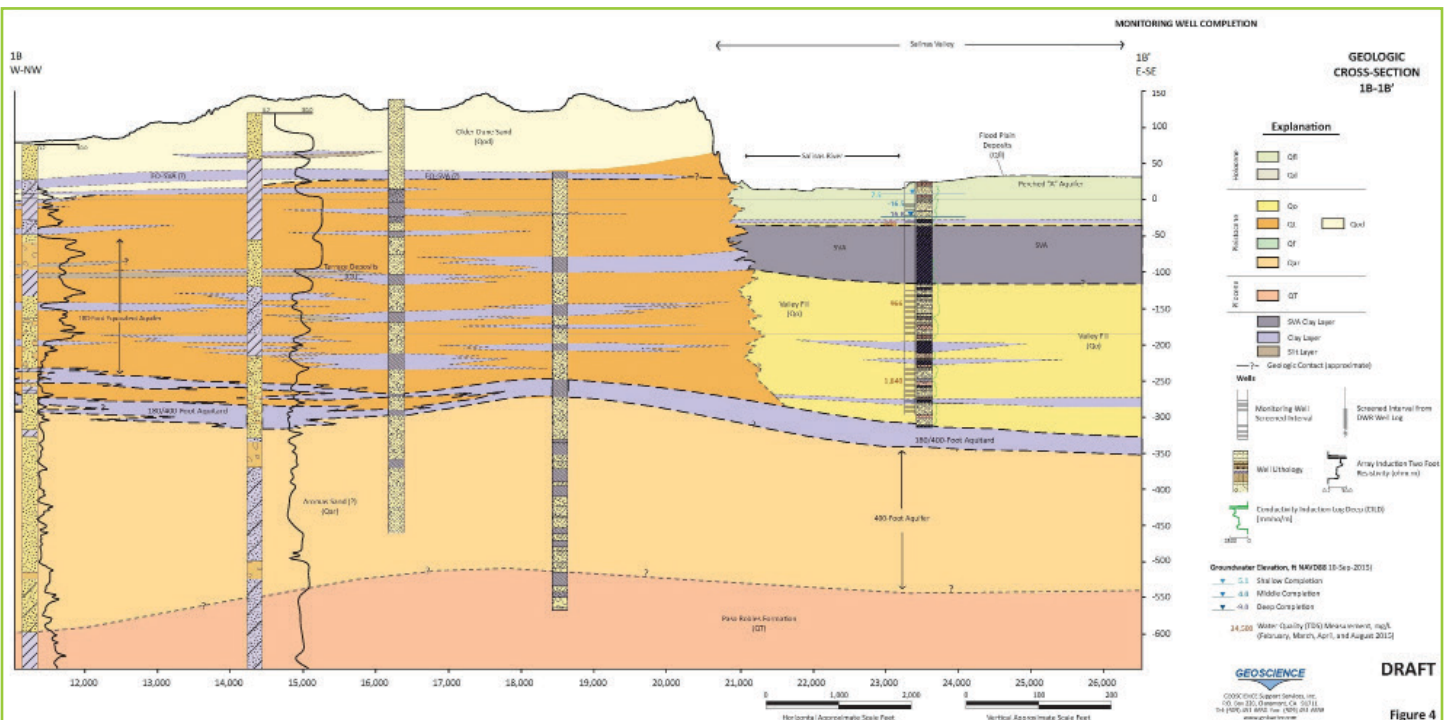

An example of a hydrogeologic cross-section that can help demonstrate the lateral extent (if any) of a regional aquifer system.

Geoscience will evaluate the geohydrology of the project area for the purpose of identifying areas or zones favorable for new production wells. Specific data to be used to assess these areas will include subsurface geology, aquifer thickness, aquifer permeability, groundwater levels and flow direction, point sources of groundwater contamination, non-point sources of contamination, location of existing infrastructure, and the location of available property for construction. All of this data will be shown in relation to existing land use, production wells, utilities, and transmission pipelines.

The final product of the evaluation will be a map showing the areas favorable for a new well and an evaluation matrix scoring the potential sites in order of most favorable. It is anticipated that eight (8) to ten (10) sites will be identified and evaluated. After review with WVWD, each recommended site will be ranked according to favorability utilizing a decision matrix. Several criteria will be assessed including, but not limited to:

- ◆ **Geohydrologic:** production potential, anticipated water quality, and water level interference

- ◆ **Environmental:** proximity to point-source sites of ground water contamination and surface water bodies
- ◆ **Logistical:** available access and area for drilling, appropriate setbacks from electrical and sanitary facilities, and disturbance to nearby businesses and/or residents
- ◆ **Engineering:** proximity to existing water transmission system and adequacy of that system
- ◆ **Cost:** project cost, including property acquisition, etc.

Each of the criteria will be weighted and evaluated in a quantitative manner according to importance. The criteria and corresponding weighting values will be prepared based on Geoscience recommendations in consideration of the WVWD’s goals.

The results of the well site assessment will be presented to WVWD as a report. The 60% and 90% DRAFT reports will be presented to WVWD in electronic format (i.e., PDF). Geoscience will meet with the District and discuss comments to the report. Comments will be incorporated and Geoscience will issue a 100% FINAL report in electronic and six (6) bound hard copies.

Potential Well Site	APN	Criteria and Weighting Factors																				Totals										
		Production Potential ¹		Interference from Existing Production Wells ^{1,a}		Groundwater Quality ^{1,a}		Proximity to Open-Case Sites of Environmental Concern ^{1,a}		Proximity to EPA Remediation Wells		Site Access and Constraints ²		Construction Impacts ¹		Proximity to Main Water Transmission Line ^{2,b}		Access to Storm Drains or Other Discharge Points ^{2,b}		Access to Construction Water Source ^{2,b}		Site Security		Proximity to Sanitary Hazards and Setbacks ^{2,a}		Current Land Use and Ownership ¹		Property Capable of Supporting Two Wells		Overall Score (of 150)	Rank (of 9)	
		Pts	Total	Pts	Total	Pts	Total	Pts	Total	Pts	Total	Pts	Total	Pts	Total	Pts	Total	Pts	Total	Pts	Total	Pts	Total	Pts	Total	Pts	Total					
		5	5	6	6	4	4	5	5	3	3	2	2	3	3	3	3	3	3	2	2	3	3	3	3	3	3	3	3			
9	013815113 013816104	3	15	2	10	3	18	2	8	3	15	3	9	1	2	4,200	1	3	3	9	3	9	1	2	3	9	2	6	3	9	124	1
6	13801111	3	15	2	10	3	18	2	8	3	15	3	9	1	2	1,300	3	9	1	3	3	9	1	2	3	9	2	6	2	6	121	2
2	13935101	3	15	1	5	2	12	2	8	3	15	3	9	3	6	450	3	9	2	6	3	9	1	2	3	9	2	6	3	9	120	3
7	13803110	3	15	2	10	2	12	2	8	3	15	2	6	1	2	1,300	3	9	3	9	3	9	1	2	3	9	1	3	3	9	118	4
8	13809224	3	15	2	10	3	18	2	8	3	15	2	6	2	4	3,900	1	3	3	9	3	9	1	2	3	9	1	3	2	6	117	5
1	14321102	2	10	1	5	2	12	2	8	3	15	3	9	2	4	950	3	9	3	9	3	9	1	2	3	9	2	6	3	9	116	6
3	13922101	3	15	2	10	1	6	2	8	3	15	3	9	2	4	50	3	9	1	3	3	9	1	2	3	9	2	6	2	6	111	7
5	13922218	3	15	2	10	2	12	2	8	3	15	2	6	1	2	375	3	9	1	3	3	9	1	2	3	9	1	3	2	6	109	8
4	13921201	3	15	1	5	2	12	2	8	3	15	2	6	1	2	375	3	9	1	3	3	9	1	2	3	9	2	6	1	3	104	9

Our evaluation will include an evaluation matrix (example shown above) that presents the scores of potential sites in order of the most favorable.

COST ASSUMPTIONS & BASIS OF PROPOSAL

1. Geoscience's Schedule and Consultants Fee included with this bid are valid for a period of 1 year assuming the starting date shown in the baseline Schedule.
2. Geoscience will manage work hours between employee classifications or utilize other employee classifications provided that the total project fee is not exceeded without prior approval of the Owner. Geoscience will first request approval from the Owner before work hours are managed between Tasks as listed in the Consultants Fee Schedule.
3. Services not Specifically Identified in the Scope of Work are not included in this Agreement for Professional Services.
4. Owner and/or Stakeholders will provide data on: Site Plans, Utility Record Drawings, Nearby Well Locations, Nearby Well Construction Details, Well Production History, Water Level History, Water Quality History, Well Maintenance History, Lithologic Logs, Geophysical Logs, Land Use Data, Known Contamination Sites Known Contamination Sites, Climatological Data, Site Ownership/Parcel Information, Gaging Station Data, Authorization Letters, Facility Details, Discharge History, or Model Files. Owner and/or Stakeholder provided data is assumed to be in an editable electronic format (eg., Excel, AutoCad GIS).
5. All owner/stakeholder furnished data required for a given Task will be provided to Consultant within a time-frame agreed upon between Consultant and Client, or as shown in the project schedule. Owner-furnished data that is received after the agreed-upon Collection Time Frame, and that necessitates a revision of analyses, calculations, design, or written deliverable, may necessitate a contract amendment.
6. Consultant assumes that data assembled and provided by the Client and/or Project Stakeholders is accurate, complete and can be used as it is. Verification of Owner furnished-data accuracy from primary source(s) is outside the scope of work.
7. One (1) round of comments and resulting deliverable revision is budgeted for each draft design deliverable as listed in the Project Deliverable Schedule. Owner will review and provide comments on the deliverable at the 60% and 90% level. Review of the 100% documents will be made to determine that changes from the 90% documents have been addressed. Responses to comments will be developed in a comment response log.
8. For review of draft deliverables, Owner will provide consolidated, written, and non-contradictory review comments to Consultant's Deliverables in an electronic, matrix format. All written review comments will be provided within a time frame as agreed upon by the Owner/Stakeholders and Consultant, or as indicated in the baseline project schedule. Owner and/or Stakeholder comments that are received after the agreed-upon deliverable review Time Frame, and that necessitate an additional revision of the deliverable, will be incorporated upon consultation with the Owner and through a contract modification.

PROJECT SCHEDULE

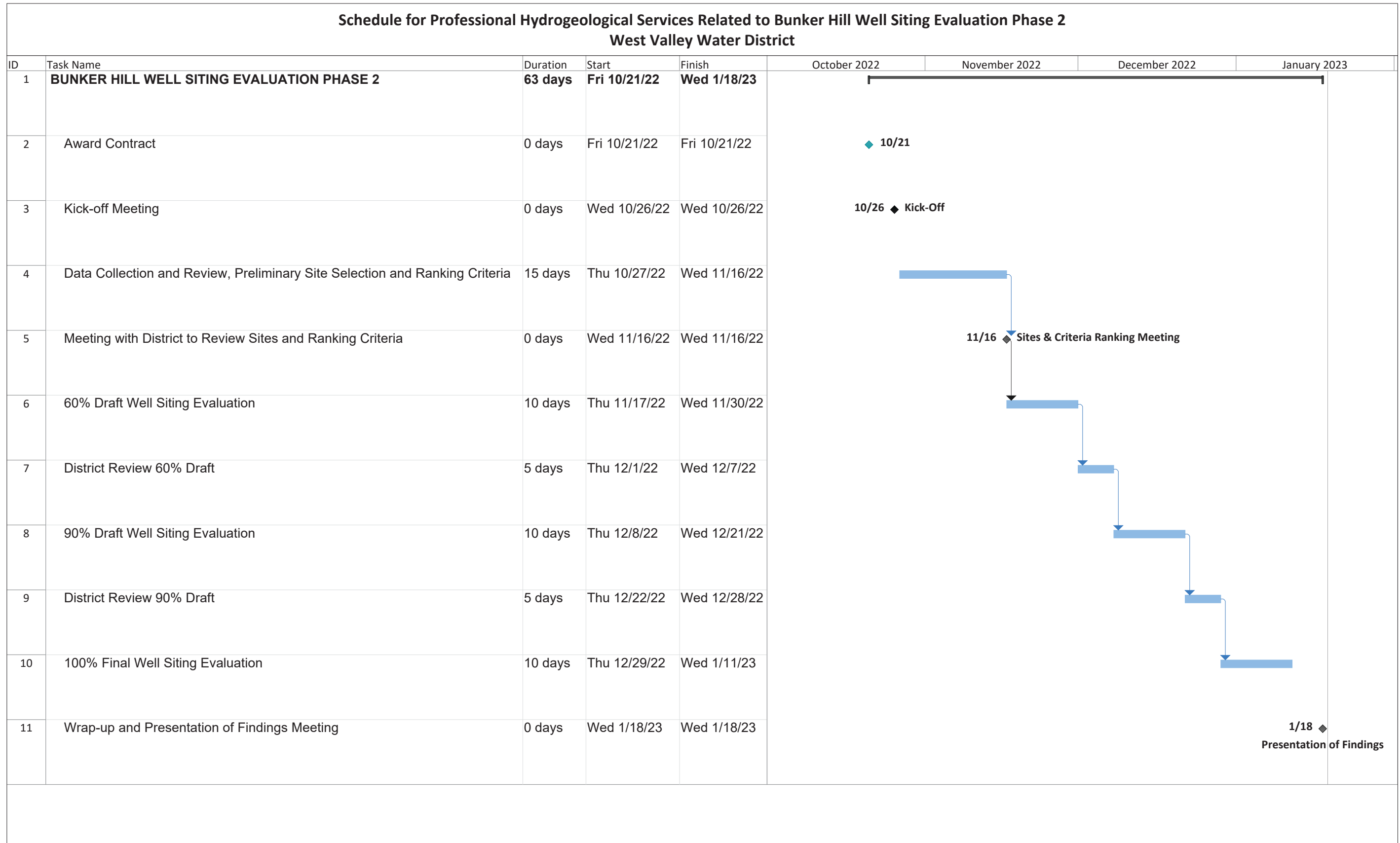

REFERENCES

RANCHO CALIFORNIA WATER DISTRICT, DISTRICT BASIN SITING STUDY

Torrance, CA

Rancho California Water District (RCWD) was seeking parcels to perform multiple groundwater recharge projects within their service area, principally in the form of surface spreading basins. Rather than only evaluating potentially desirable parcels individually and approaching owners to purchase property, RCWD also wanted the ability to evaluate and respond to market opportunities as desirable parcels become available. This required an understanding of all the parcels in the service area in terms of their suitability for groundwater recharge projects. Manual evaluation of parcels for such projects has been used previously, but the utilization of GIS allows for a more thorough, basin-wide quantitative approach. GIS-based evaluation also allows for quick and easy adjustment of rankings and weights, such as when new information about aquifer characteristics becomes available, as well as adding additional factors or removing factors. This increase in capabilities has the potential for saving both time and money by streamlining the process of locating new areas for optimal groundwater recharge.

Parcels within the RCWD service area were evaluated as to their suitability for the installation of a new recharge project in terms of geohydrology, permitting, and infrastructure

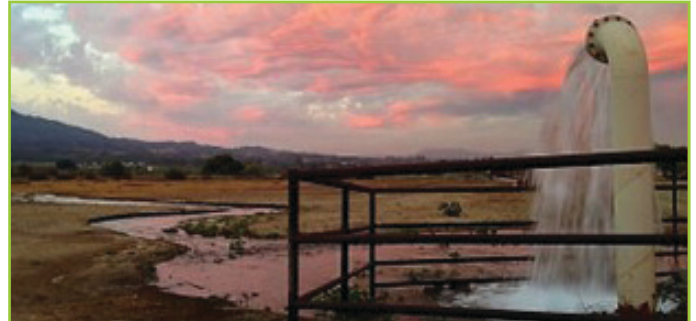

factors. Data in these three categories were processed in a site suitability model constructed to calculate a unique total score for each parcel. Hydrogeology factors such as hydraulic conductivity and unsaturated thickness were taken from a calibrated groundwater model in the basin and scored based on the potential for recharge storage. Permitting factors such as the location of wetlands and conservation easements were used to exclude areas from consideration. Infrastructure factors such as the location of existing production wells and water mains were scored based on proximity. Factors in all three categories such as geology, FEMA flood zones, and parcel land use were scored based on desirable elements. Parcels that received the highest calculated scores were then evaluated via a site visit to confirm model results and identify possible pitfalls that were not identified by the GIS model.

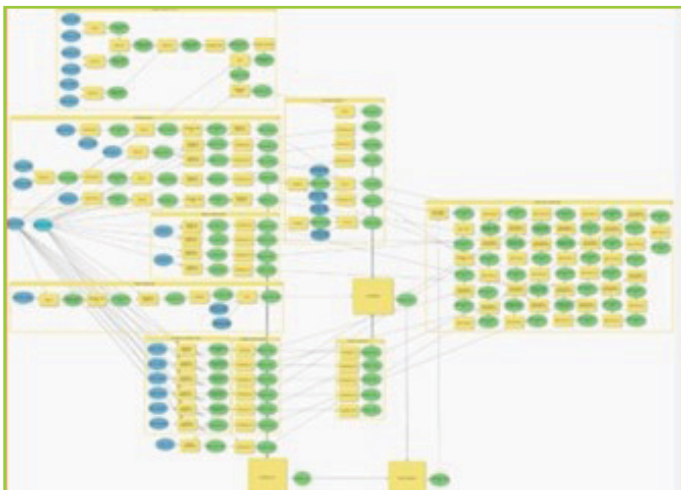

Site suitability matrix

Project Data

Client: Rancho California Water District
 Client Contact: Rich Ottolini, Operations Mgr
 Address: 42135 Winchester Rd., Temecula, CA 92590
 Phone: (951) 269-6954
 Project Date: July 2021 - January 2022
 Scope of Services:

- Basin-wide Siting Evaluation
- GIS-based analysis

MIRAGRAND WELL DESIGN & CONSTRUCTION

City of Claremont, CA

Geoscience was retained by Three Valleys Municipal Water District (TVMWD) to provide design-build services for a new municipal water supply well, referred to as the Miragrاند Well, located in the Upper Claremont Heights basin, one of six small adjacent and interconnected basins located on the northern edge of the Chino Basin.

Geoscience provided **well siting**, technical specifications, and preliminary and final design for the drilling, construction, development, and testing of the Miragrاند Well. Once the design was completed, we provided construction management and observation to drill the initial borehole. A 48-inch diameter conductor borehole was drilled to a depth of approximately 51 ft bgs using a rig equipped with a solid stem auger. Below the bottom of the conductor casing, a 17 1/2-inch diameter pilot borehole was drilled using a fluid reverse circulation rotary drilling rig



Auger drilling for the conductor casing placement

to a final depth of 770 ft bgs. Geoscience also provided observation to conduct and complete the isolated aquifer zone testing. The purpose of isolated aquifer zone testing is to determine both yield and water quality from the potential completion interval(s) before determining the final design of the well. Three (3) zones were selected for testing prior to preparing the final recommended well design, which included the selection of the screened interval, slot size, and filter pack gradation. The selection of the zone test intervals was based upon visual examination of the formation samples and analysis of the geophysical logs. In addition to the pilot borehole drilling, and isolated aquifer zone testing, construction of the Miragrاند Well also included borehole reaming, well construction, well development, and pump testing.

Once completed, the well successfully produced 600 gallons per minute (gpm).



Borehole reaming for the Miragrاند Well

Project Data

Client: Three Valleys Municipal Water District
 Client Contact: Benjamin Peralta
 Address: 1021 E Miramar Ave, Claremont, CA 91711
 Phone: (909) 621-5568
 Project Date: March 2020 - December 2021

Scope of Services:

- Well Siting
- Well Preliminary Design Reports
- New Well Design and Construction
- Quality Assurance/Quality Control
- Project Administration

ADDITIONAL INFORMATION

For more than 40 years, Geoscience has focused on only one thing; groundwater. We were one of the first firms in the State to focus solely on groundwater modeling, studies, and groundwater production wells. During this time, we have completed more than **2,000** groundwater studies and more than **1,000** well design projects.

Our expertise comes from practical, hands-on experience designing and working on numerous municipal high capacity water wells. We also design and supervise well construction for municipal and private clients and are often called upon to help increase water production efficiency, and troubleshoot and test existing wells for water quality and other issues. We routinely assist agencies in assessing and managing well infrastructure to prolong well life, minimize long term expenses, and improve water supply reliability.

The tables below illustrates our other recent experience in siting, designing, developing and constructing production wells. We have listed the beginning and end dates, and our client contacts for each project. Detailed descriptions have been provided for a few of the projects listed below.

OUR EXPERIENCE *by the Numbers*

MORE THAN 2,000

Groundwater studies & modeling projects completed

proven consulting expertise in groundwater modeling and hydrogeologic studies

MORE THAN 20

Well projects represented

in the list of projects presented on the following page - exhibiting our relevant, recent experience that proves we can handle this project

MORE THAN 100

Municipal production wells

completed by Geoscience in the last decade - demonstrating proven experience that we can maximize well production, while minimizing project delays and cost overruns

Geoscience Team Project and Client	Project Dates	Project Reference	Well Siting & Design	Well Development & Construction	Completed On Schedule
Bunker Hill Well Siting Evaluation Phase 1 (Siting only)	2019 - 2020	West Valley Water District, 855 W. Baseline Rd., Rialto, CA 92376; Linda Jadeski, (909) 820-3713	X		X
Extraction Well Nos. CDA II-10, CDA II-11, & CDA-II-12	2017 - 2021	Chino Basin Desalter Authority, 3550 E Philadelphia St Suite 170, Ontario, CA 91761; Tom O'Neill, (909) 218-3729	X	X	X
Well No. 28	2019 - 2020	City of Lakewood, 5050 Clark Avenue, Lakewood, CA 90712; Derwin Dy, (562) 866-9771	X	X	X
North Torrance Well Field Well Nos. 10 & 11	2019 - 2021	City of Torrance, 3031 Torrance Blvd., Torrance, CA 90503; John Dettle, (310) 618-3059	X	X	X
Exploratory Drilling in the Lee Lake Groundwater Basin and Lee Lake Well Nos. 1 & 2	2018 - 2022	Elsinore Valley Municipal Water District, 31315 Chaney St., Lake Elsinore, CA 92530; Jesus Gastelum, (760) 518-6266	X	X	X
Well Destruction & Replacement - Warren Well	2018 - 2019	Hillwood Properties, 901 Via Piemonte, Ontario, CA 91764; John Grace, (909) 256-5924	X	X	X

WEST VALLEY WATER DISTRICT, BUNKER HILL SUBBASIN WELL SITING STUDY

San Bernardino County, CA

West Valley Water District (WVWD) provides water service to approximately 82,000 people through 22,000 service connections. To bolster its groundwater supply and reduce reliance upon imported water sources, WVWD investigated the develop additional assets in the Bunker Hill Groundwater Subbasin of the Upper Santa Ana Valley Groundwater Basin that underlies the San Bernardino Valley. The Bunker Hill Groundwater Subbasin contains some of the most productive and prolific groundwater aquifers within the Upper Santa Ana Groundwater Basin. However, groundwater contamination and over-pumping are of concern. To drill and construct new groundwater wells that maximize production potential while meeting water quality objectives, WVWD commissioned a comprehensive well site evaluation to identify the most advantageous locations in the Bunker Hill Subbasin. Geoscience was retained to prepare Phase 1 of a well site evaluation to identify the viable candidate locations for future groundwater extraction. The purpose of the Phase 1 site evaluation report was to conduct an initial assessment and evaluate and rank each potential well site. Each site was evaluated based specific factors to determine its suitability for the installation of a municipal groundwater supply well.

Before starting the well site evaluation and ranking process, our team developed a preliminary list of 36 parcels in coordination with WVWD utilizing GIS-based software that fulfilled the initial criteria. Many of these parcels are located adjacent to each other and therefore were lumped together for consideration as one site. Based on this, the total number of parcels was reduced to nine potential sites for consideration for the future construction of new municipal groundwater supply wells. Each of the potential well sites were evaluated for its geohydrologic and engineering suitability as a construction site for new municipal groundwater supply well(s). The geohydrologic evaluation relied previous work performed by Geoscience in the Bunker Hill Subbasin and other published physical and chemical data, whereas the engineering evaluation primarily relied on aerial and street-level photography. In particular, this evaluation included an assessment of the following criteria:

Geohydrology:

- ◆ Production potential
- ◆ Interference with existing production wells

- ◆ Groundwater quality
- ◆ Proximity to open-case sites of environmental concern
- ◆ Proximity to EPA remediation wells

Engineering:

- ◆ Site access and constraints
- ◆ Construction impacts
- ◆ Proximity to main water transmission line
- ◆ Access to storm drains or other discharge points
- ◆ Access to construction water source
- ◆ Site security
- ◆ Proximity to sanitary hazards and setbacks
- ◆ Current land use and ownership
- ◆ Land for two wells

Each of the nine potential well sites were then ranked in order of favorability, with one being the most favorable, according to Geoscience’s proven methodology. All fourteen criteria were assessed for each site using a three-point scale, where one point indicates the least suitable site and a score of three points indicates the most suitable. Weighting factors were then assigned to each criterion, with factor values ranging from one (1) to five (5) indicates the greatest significance). The products of each site’s criteria scores and the corresponding weights were added to obtain the total weighted scores and site rankings.

Based on our evaluation, Potential Well Site 9 was ranked the highest and was considered the best suited location for one or two new municipal production wells. According to the results of the siting study, a well constructed on this property could potentially produce the desired groundwater volumes and was expected to have favorable water quality while meeting production expectations. The good production potential of this site, combined with its excellent access, availability of construction water, and sufficient area to drill two wells, makes it a good site to construct new groundwater well(s). Three other potential well sites were also presented as Alternative Sites.

Project Data

Client: West Valley Water District

Project Date: 2019 - 2020

Scope of Services:

- Well Siting Evaluation
- GIS-based analysis

CDA EXTRACTION WELL Nos. II-10, II-11, AND II-12

Riverside, CA

The Chino Basin Desalter Authority (CDA) selected a team including Geoscience to provide design, construction management, and inspection services for three groundwater extraction wells in the southern portion of the Chino Basin, where complex water-bearing zones consisting of interlayered sands, gravels, silts, and clays comprise the aquifer system.

Geoscience provided technical specifications and design for the drilling, construction, development, and testing of all three ground water extraction wells, referred to as CDA Well Nos., II-10, II-11, and II-12 located in the Cities of Eastvale and Ontario, California. All three wells provided feed water to the CDA Desalter II plant, with II-12 also serving as a mitigation measure for the cleanup of the South Archibald TCE plume. This work required additional effort in coordination with the Santa Ana Regional Water Quality Control Board who oversaw the cleanup of the plume.

Once the design was completed, Geoscience provided construction management and field supervision during drilling and construction of all three wells. The wells were drilled using the fluid reverse circulation rotary drilling method. Construction each well included pilot borehole drilling, isolated aquifer zone testing, borehole



Pilot borehole drilling for CDA-II-12

reaming, well construction, well development, and pump testing.

Following completion II-12, the well was modified so that production from only the upper screened interval could be possible. The purpose of this was to produce only contaminated groundwater containing TCE, thereby maximizing the cleanup effort, but maintaining access to the lower, clean water once the contaminant plume was mitigated. This modification was accomplished by backfilling the lower casing and screened interval of the well with gravel and placing a thin cement cap above that. The modification was performed to allow for the easy removal of the backfill material at a future date when production from the lower screened interval is desired.



Zone testing at CDA-II-11

Project Data

Client: Chino Basin Desalter Authority
Project Date: 2014 - 2021

Scope of Services:

- Well Siting & Preliminary Design Report
- Well Development & Construction
- Well CM & Inspection
- Point Source Contamination

ELSINORE VALLEY MUNICIPAL WATER DISTRICT, EXPLORATORY DRILLING AND FINAL WELL DESIGN AND CONSTRUCTION IN THE LEE LAKE GROUNDWATER BASIN - LEE LAKE WELL NOS. 1 AND 2

Riverside County, CA

As part of their near-term water supply program, Elsinore Valley Municipal Water District (EVMWD) wished to develop groundwater resources in the Lee Lake Groundwater Basin to meet the anticipated increase in potable water demand due to rapid population growth over the next 20 years. Their intent was to optimize their groundwater resources in the next two to three years in order to increase the potable supply while also reducing their dependence on imported water sources. One of the projects for this program was the drilling and testing of suitable sites previously identified for two new groundwater production wells.

After identifying a suitable location for the drilling and testing of two new groundwater production wells, a test borehole was drilled to verify the site suitability by use of the air rotary casing hammer (ARCH) drilling method. The ARCH drilling method was selected due to the poorly consolidated coarse-grained alluvial material in which the borehole was drilled. This method was also selected for its ability to provide representative formation samples critical to the investigation, as well as reliable groundwater elevation data. Once the total depth of the borehole was achieved, drilling mud was introduced to the borehole, the casing was removed, and a suit of geophysical log was performed. Based on the data obtained from the investigation, a very accurate preliminary design of the production wells was developed.

This test borehole was one component of a much larger, multi-phase project throughout the EVMWD service area. Geoscience was responsible for the development of a work plan for the test drilling, field inspection during drilling and testing, and the development of



the preliminary well designs for the municipal groundwater supply wells.

Geoscience was then selected to provide final design, construction management, and observation support for the two new groundwater production wells – referred to as EVMWD Lee Lake Well Nos. 1 and 2. Once the final design was completed, Geoscience staff provided bid support, construction management and observation to drill the initial borehole and complete isolated aquifer zone testing. Based on the results of the zone testing, we completed the final design and observed well completion including well development by airlifting and swabbing, aquifer testing, and final down-hole video inspection.

Project Data

Client: **Elsinore Valley Municipal Water District**
Project Date: **July 2018 - February 2022**

Scope of Services:

- Well Siting
- Well Preliminary Design Reports
- New Well Design and Construction
- Quality Assurance/Quality Control
- Project Administration

CITY OF LAKEWOOD, WELL No. 28

Lakewood, CA

The City of Lakewood relies on groundwater for its municipal water supply and currently uses a network of 10 active production wells. To improve supply reliability and meet increased demand in the future, the City installed a new well (Well No. 28) at the City public works yard.

Our team previously completed several wells adjacent to Well No. 28, and **helped the City assess the suitability of the selected site.**

Geoscience was then selected to develop a Preliminary Design Report (PDR), provide final design, and construction management and observation support.

To develop the PDR, we reviewed existing data, assessed contaminant sources, developed a preliminary design, reviewed construction constraints including site layouts, and developed an initial cost estimate. Because several production wells were within close vicinity of the project area, we assess well drawdown and interference on the proposed well.



Once the PDR was completed, we provided bid support and provided construction management and observation to drill the initial borehole and complete isolated aquifer zone testing. The zone testing helped identify well screen depths to maximize groundwater quality since the area had historically high levels of arsenic. Also, the project site was typical of the Los Angeles Basin and had extremely fine-grained sediments, making filter pack and well screen design critical to reduce sand production and turbidity. Based on the results of the zone testing, we completed the final design and observed well completion including well development by airlifting and swabbing, aquifer testing, and final down-hole video inspection.

Once completed, the well successfully produced 2,500 gallons per minute (gpm). The zone testing efforts were extremely successful and helped the well meet and exceed water quality standards in an area with known water quality issues.



Installation of conductor.

Project Data

Client: City of Lakewood
Project Date: 2019 - 2020

Scope of Services:

- Well Siting
- Well Preliminary Design Reports
- New Well Design and Construction
- Quality Assurance/Quality Control
- Project Administration



CITY OF TORRANCE, NORTH TORRANCE WELLFIELD WELL NOS. 10 AND 11

Torrance, CA

The City of Torrance selected a team including Geoscience to provide design-build services for Wells No. 10 and 11 in the North Torrance Wellfield (NTWF), as well as demolition services for Well No. 6. Geoscience previously provided design and construction services for NTWF Well No. 9, which replaced Well No. 6 in 2009.

We provided technical specifications and preliminary design for review and approval by the City. Once the design was completed, we provided construction management and observation to drill the initial boreholes and complete isolated aquifer zone testing. The zone testing helped identify well screen depths to maximize groundwater quality since the project site was typical of the Los Angeles Basin and had extremely fine-grained sediments, making filter pack and well screen design critical to reduce sand production and turbidity. NTWF Well No. 10 construction included the installation of the conductor casing and drilling and testing the pilot borehole conducted in 2009. The Well No. 10 pilot borehole was backfilled in 2009 pending the decision made by City of Torrance to ream the borehole and complete the Well No. 10 construction during 2019 to 2020. NTWF Well No. 11 construction included pilot borehole drilling, isolated aquifer zone testing, borehole reaming, well construction, well development, and pump testing. Our services on the project also included:

- ◆ Obtaining and reviewing background geohydrologic data and preparing a preliminary design.
- ◆ Coordination with Division of Drinking Water and LA County health for variance requests.
- ◆ Providing pump design recommendations, including short- and long-term drawdown, recommended discharge rate, and pump setting.

The design maximum total production from the well field (NTWF Well Nos. 9, 10, and 11) is 9,000 gallons per minute (gpm) which will allow the City to fully utilize its existing water right and provide surplus capacity to allow for well maintenance or local production in the event of an emergency that interrupts groundwater imports.

Project Data

Client: City of Torrance
Project Date: 2019 - 2021

Scope of Services:

- Well Siting
- Well Preliminary Design Reports
- New Well Design and Construction
- Well Demolition
- Quality Assurance/Quality Control
- Project Administration

GEOSCIENCE

The First Name in Groundwater



**BOARD OF DIRECTORS
STAFF REPORT**

DATE: October 20, 2022
TO: Board of Directors
FROM: Van Jew, Acting General Manager
SUBJECT: SOFT START MOTOR DRIVE FOR 4-1 PUMP STATION

BACKGROUND:

The pumping equipment at the 4-1 Pump Station is equipped with a 25-year-old open architecture soft start motor drives which are now obsolete and cannot be repaired. Pump No. 1 at that facility has failed and needs to be replaced. District staff has been replacing old motor drives of this type with Allen Bradley brand digital soft start motor drives as the older drives fail.

DISCUSSION:

District staff selected the Allen Bradley devices based on cost, heat tolerance, reliability, ease of programming and operation, and the compatibility with the district's current and future control systems. District Staff has been trained on the Allen Bradley brand products and is able to reduce the District's reliance on outside contractors for the installation and programming of those devices.

This a sole source item. Royal Industrial Solutions (Royal) is the sole distributor to sell Allen Bradley associated products. Attached as **Exhibit B** is the sole source justification form. The quote from Royal for the requested motor drive totaled to \$7,968.42. Attached as **Exhibit A** is the quote. The quote expires on October 31, 2022 and the lead time is approximately 30 days. Staff is recommending a purchase order be issued to Royal in the amount of \$9,000.00 to account for a slight contingency for unforeseens.

FISCAL IMPACT:

This item will be paid for using budgeted funds from O&M Production – Repair & Maintenance / Structures / Facilities 100-5210-540-5614.

STAFF RECOMMENDATION:

Staff recommends that the Board of Directors to issue a purchase order to Royal in the amount of \$9,000.00 for a motor drive.

Respectfully Submitted,

Van Jew

Van Jew, Acting General Manager

VJ:jc

ATTACHMENT(S):

1. Exhibit A - Quote
2. Exhibit B - Sole Source Form

MEETING HISTORY:

10/12/22 Engineering, Operations and Planning Committee REFERRED TO BOARD

EXHIBIT A

ROYAL INDUSTRIAL SOLUTIONS
 3200 RUSSELL ST
 RIVERSIDE CA 92501
 TEL: 951 683-6625 FAX: 951 787-9883

CONTACT: COUNTER

QUOTE FOR: WEST VALLEY WATER DISTRICT
 ACCT #: HJ-63371 WEST VALLEY WATER DISTRICT

WATER DISTRICT
 P O BOX 920
 RIALTO, CA 92376

QUOTATION		PAGE	
QUOTE #	DATE	REV #	REV DATE
1268396	05/17/22	004	09/22/22
QUOTE EXPIRES		PREPARED BY	
10/31/2022		MEB	
SLS		INSL	
2380		1014	
FOB		FREIGHT	
SHIPPING POINT		PICKUP	

CUS PO #:
QUOTE
JOB NAME:

LN	QTY	MFR	CATALOG #	DESCRIPTION	PRICE	UOM	EXT AMT
01	1	AB	150-C317NBD	600V MOTOR CNTRLR	7,327.28	E	7,327.28

MDSE:	7,327.28
TAX:	641.14
TOTAL:	7,968.42

PLEASE NOTE: THIS IS NOT AN OFFER TO CONTRACT, BUT MERELY A QUOTATION OF CURRENT PRICES FOR YOUR CONVENIENCE AND INFORMATION. ORDERS BASED ON THIS QUOTATION ARE SUBJECT TO YOUR ACCEPTANCE OF THE TERMS AND CONDITIONS LOCATED AT SALES.OUR-TERMS.COM, WHICH WE MAY CHANGE FROM TIME TO TIME WITHOUT PRIOR NOTICE. WE MAKE NO REPRESENTATION WITH RESPECT TO COMPLIANCE WITH JOB SPECIFICATIONS.

EXHIBIT B

ALLEN BRADLEY SOFT START MOTOR DRIVES

Sole Source Justification

1. Why do we need to acquire the goods and services?

This device will be replacing a failed motor drive that is obsolete and is no longer able to be repaired.

2. Why are the goods or services the only ones that can meet your needs?

The decision to use Allen Bradley products was based on the cost of the product, the ease of installation and setup, the quality and reliability of these drives, and the seamless integration with the Allen Bradley PLC that will be part of a planned SCADA upgrade that will be starting in the near future.

Standardizing allows Electrical & Instrumentation Staff to minimize product specific training and be more familiar and able to diagnose problems with those devices.

3. Were alternative goods/services evaluated? If yes, why are those unacceptable?

There are similar devices that would be suitable for our application, however the District's Electrical & Instrumentation staff made the decision to standardize on Allen Bradley motor drives and has been replacing failed drives with this brand.

4. What efforts were made to get the best price?

Part of the evaluation of the Allen Bradley motor drives was the cost to purchase, the cost to integrate the device with existing and future control systems, availability, and the cost to train staff on programming the device.

5. Why is price fair and reasonable?

A careful evaluation was performed against several similar devices, the cost overall cost to purchase, install, program, and integrate the Allen Bradley device was the lowest.

6. What impact is there if the sole source is not used?

Royal Wholesale Electric is the sole supplier of the Allen Bradley motor drives used by the District in this region. A letter from Rockwell Automation (Allen Bradley Parent Company) is included with the documents for this this purchase request.

Recommendation:

Supervisor/Department Head Signature:  Date: 9/22/22
Joe Schaack

Supervisor/Department Head Print Name: _____

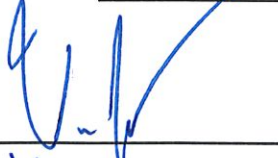
General Manager Signature:  Date: 9/22/22

General Manager Print Name: Van Jew

Los Angeles Office
10805 Holder St, Suite 300
Cypress CA 92806
Tel 714-938-9000

Rockwell
Automation

May 9, 2019

Joe Schaack
West Valley Water District
855 W Baseline Rd
Rialto CA 92376

Re: Rockwell Automation Authorized Distributors/Royal Industrial Solutions

Dear Mr. Joe Schaack:

Rockwell Automation extends and enhances its own significant automation capabilities by partnering with a network of authorized distributors in order to ensure we are able to meet our customers technical and logistics requirements. Just a few of the many benefits that customers enjoy working with their local authorized Allen-Bradley distributor include:

- Access to local distributor inventory (including for spares and replacement parts)
- Technical assistance from local distributor product specialists
- A knowledgeable staff that has access to factory training
- Rockwell Automation provided factory support of local distributor activities

This is to confirm that Royal Industrial Solutions currently is the only distributor appointed and authorized to sell Allen-Bradley Standard Controls, Drives, PLC/MMI, Rockwell Software products and all services offerings in the geographic area in which your facility in Rialto is located. As a matter of Company policy, full factory product and sales support is made available only to the local authorized distributor, and it is Rockwell Automation's practice and policy to always promote and recommend the use of that distributor to customers in that geographic area.

Should you have any questions, please do not hesitate to contact Royal Industrial Solutions at (951) 683-6625 or our local Rockwell Automation sales office at (714) 938-9000.

Respectfully,

Keith Hornberger
Rockwell Automation
Channel Account Manager
714-306-2372 cell
kahornberger@ra.rockwell.com

cc:

Tyler Brubaker – Royal Industrial Solutions
Gabriel Oduna – Royal Industrial Solutions

LISTEN.
THINK.
SOLVE.



**BOARD OF DIRECTORS
STAFF REPORT**

DATE: October 20, 2022
TO: Board of Directors
FROM: Van Jew, Acting General Manager
SUBJECT: CACTUS BASIN 2 MAINTENANCE ACTIVITIES

BACKGROUND:

In May 2016, the West Valley Water District (District) and the San Bernardino County Flood Control District executed an agreement permitting the spreading of water in Cactus Basin 2 (Basin) to support the District's Fluidized Bed Bioreactor (FBR) Groundwater Treatment project. The District is responsible for obtaining regulatory permits and performing all maintenance activities. Burrowing owl and nesting bird survey was completed in September 2022, and the District has received permission from the California Fish and Wildlife to proceed with mowing down vegetation in Cactus Basin 2, removing them, and disposing them in October 2022.

DISCUSSION:

The District's landscaping contractor, California Landscape & Design, submitted a quote in the amount of \$24,945.00 for the specified services. Attached as **Exhibit A** is the quote. The project must be completed before bird nesting season, and before rain season so the basin would be dried for contractor to perform the specified services.

FISCAL IMPACT:

This item is included in the Fiscal Year 2022/23 Operating Budget and will be funded from project number GL100-5350-536-5473 titled "Miscellaneous/Permits & Fees".

STAFF RECOMMENDATION:

Staff recommends that the Board of Directors to issue a Purchase Order to California Landscape & Design in the amount of \$24,945.00 for Cactus Basin maintenance activities.

Respectfully Submitted,

Van Jew

Van Jew, Acting General Manager

VJ:jc

ATTACHMENT(S):

1. Exhibit A - Quote

MEETING HISTORY:

10/12/22 Engineering, Operations and Planning Committee REFERRED TO BOARD

EXHIBIT A



Bid Proposal

Date: September 27, 2022
Name: West Valley Water District
Address: 855 W Baseline Rd. Rialto CA 92376
Phone: (909) 644-6910, (909) 875-1804 ext. 717
Project: Removal of Plant Material and Disposal from Water Basin
Attn: Sergio Granda
Email: sgranda@wvd.org

Proposal # 402
Valid Until: January 1, 2023

Quantity		Unit	Description	Unit Price	Ext. Price
Removal of Plant Material and Disposal from Water Basin					
13.5 Acres Approx					
6	Container		40 YD High Wall Trash Containers	\$ 600.00	\$ 3,600.00
1	LS		Miscellaneous Materials/Tools	\$ 200.00	\$ 200.00
13.5	Acre		Tractor	\$ 150.00	\$ 2,025.00
NOTE: Mowing weeds inside of basin and etc.					
5	Day		Tractor Rental	\$ 600.00	\$ 3,000.00
48	Hour		Tractor Operator	\$ 65.00	\$ 3,120.00
200	Hour		Labor	\$ 65.00	\$ 13,000.00
NOTE: Manual removal of weeds and clean up					



We propose hereby to furnish material and labor complete in accordance with above specification for the sum of: **\$ 24,945.00**

Customer _____ Date _____ License Number 597267 (Class C27)

The above prices, specifications and conditions are satisfactory and are hereby accepted. You are authorized to perform the work specified.

This project was completed on: _____ **Sign:** _____

Any questions concerning a contractor may be referred to the Contractors State License Board, P.O. Box 26000 Sacramento, CA 95826



**BOARD OF DIRECTORS
STAFF REPORT**

DATE: October 20, 2022
TO: Board of Directors
FROM: Van Jew, Acting General Manager
SUBJECT: ARCHITECTURAL SERVICES FOR BUILDING “C” IMPROVEMENTS

BACKGROUND:

The West Valley Water District (“District”) has identified a need to improve Building “C”. The project goal is to upgrade and optimize the facilities for the Meter and Distribution Departments. The improvements will include new offices, breakrooms, restrooms, showers, lockers, laundry, and AC, lighting, and fire system upgrades.

District Staff invited six Consultants to submit a Request for Conceptual Design Proposal (RFP). The RFP identified the areas to be considered for improvements and the scope of the project.

District Staff received a total of three proposals. The three Consultants and proposals are summarized below:

Consultant	Proposed Cost
Miller Architectural Corporation	\$24,775.00
SVA Architects, Inc.	\$51,820.00
Gillis + Panichapan Architects, Inc.	\$53,160.00

Staff has reviewed the proposals and confirmed that Miller Architectural Corporation best meets the District’s needs. Attached as **Exhibit A** is the proposal submitted by Miller Architectural Corporation.

FISCAL IMPACT:

The cost to perform the conceptual design is \$24,775.00. This will provide the District with a minimum of 3 architectural design concepts for improvements to Building “C” identifying all the required permits along with associated construction costs for the District to select the design concept that best meets its needs. This item was included in in the Fiscal Year 2022/23 Capital Improvement Budget with a budget of \$75,000.00.

STAFF RECOMMENDATION:

Staff recommends that the Board of Directors to authorize entering into an agreement with Miller

Architectural Corporation in the amount of \$24,775.00 to provide architectural services for design concepts for Building "C" improvements.

Respectfully Submitted,

Van Jew

Van Jew, Acting General Manager

MB:ls

ATTACHMENT(S):

1. Exhibit A - Miller Architectural Corporation Proposal

MEETING HISTORY:

10/12/22 Engineering, Operations and Planning Committee REFERRED TO BOARD

EXHIBIT A



September 6, 2022

West Valley Water District
855 West Base Line Road
Rialto, CA 92377

Re: Architectural Services for Design Concepts
For Building "C" Improvements

Dear Mr. Bravo:

We are pleased to submit a proposal to provide architectural design services for the WVWD Building "C" located at 855 West Base Line Road. We understand the scope of work for this project to entail the following services:

- Facility assessment, programming and floor plan design services for renovations to the existing 5,000 SF Building "C".

Services generally include but are not limited to all services necessary to study, evaluate, program, design, produce construction documents and administer construction administration. Specifically, these services include:

- Facility Assessment
- Field Measurement and creation of as-built floor plan
- Programming
- Cost Estimating
- Architectural
 - Project management of all investigation and assessment of the existing facility systems for architecture services
 - Programming, space planning and floor plan design concepts.

We intend to provide the following services:

Task 1 - Project Initiation Fee - Not Applicable

Task 2 - Project Management Project Information

1. Provide all services required by the Architectural Space Programming Phase
2. Research requirements of local regulatory agencies.
3. Programming meetings with the Owner to establish requirements and determine needs for the project. (Includes 3 meetings)
4. Measure & document existing premises as needed and observe existing conditions
5. Field verification of site and facility conditions by Architect
6. Prepare a background floor plan drawing illustrating existing conditions.

Task 3 - Schematic Design

1. Provide all services required by the Schematic Design Phase
2. Meetings with the Owner to establish requirements and determine detailed needs for each space for the project to fine tune program and adjacency needs. (Includes 3 meetings)
3. Prepare floor plan review to determine final scope requirements
4. Modify as necessary floor plan to accommodate required ADA accessibility for approval of the final floor plan layout.

Utah
Nevada
Idaho
California

1177 Idaho Street
Suite 200
Redlands, CA 92374
P 909.335.7400
F 909.335.7299
An Architectural Corporation

We will provide the above services on a time and materials basis with and estimated not to exceed amount per the breakdown below:

Task 1 Project Initiation Fee (N/A)	-0-
Task 2 Project Information	\$10,825.00
Task 3 Schematic Design	\$13,550.00
Total	<u>\$24,375.00</u>
Estimated reimbursable	\$400.00
Total with reimbursable	<u>\$24,775.00</u>

Additional Services –

1. Changes to the scope of work during any phase of the contract shall be billed in accordance with the attached hourly rate schedule.
2. Services beyond submitting and allowing the review process to run its normal course shall be billed hourly in accordance with the attached hourly rate schedule. These services include but are not limited to phone calls to assure timely processing, tracking documents lost by government agencies and other efforts necessary to assure the government agencies are moving the project through the process.

Expenses and services beyond the above-described scope shall be billed in accordance with the attached fee schedule. The Owner permits the Architect to take photographs of the property during construction and upon completion of the work.

Payments on account of services rendered, and for reimbursable expenses incurred, shall be made monthly upon presentation of Architect’s statement of services. Architect may charge interest at a rate of 1% per month for unpaid balances over 30 days late. Work may stop on this project if an invoice is past due by more than 30 days. Collection efforts including liens will be pursued for invoices more than 90 days past due. The Owner agrees that the Architect has a lien on any money or property recovered in satisfaction or partial satisfaction of your claim in any matter in which you have retained the Architect. This lien is not limited to fees and costs incurred in the specific matter from which a settlement or judgment arose but applies to all fees and costs the Owner owes the Architect for any legal services provided.

This Agreement may, without cause, be terminated by either party upon not less than seven days’ written notice of withdrawal in the event that the either party fails to meet to their obligations, or in the event either party determines, with reasonable discretion, that it would be unethical or impractical to continue in this or any other matter. In the event of termination, the Architect shall be compensated for services performed prior to termination, together with Reimbursable Expenses. The Architect reserves the right to make final selection of consultants. This Agreement constitutes the full understanding of the terms of the agreement, superseding any prior oral or written understanding, and may not be amended or modified except by a writing signed by both the Architect and Owner.

Owner Responsibilities:

1. Agency review and processing
2. Access to site
3. Record Drawings

The following items are excluded from this proposal:

- Reproduction Costs (except for Architect’s in-house use)
- Title Information (Radius Map, etc.)
- Environmental Impact, CEQA & Traffic Reports
- Agency Fees
- Construction Related Testing/Reports
- Project Scheduling

- Landscape Architecture
- Fire Sprinkler Design Engineering and calculations
- New electrical main service or service upgrade

If you would like us to proceed, and are in agreement with the above, please sign where indicated below and return one signed copy for our files or prepare a purchase order. Work on this project will commence after receipt of the signed proposal or purchase order. Thank you for this opportunity to be of service; we look forward to working with you on the successful completion of this project.

Sincerely,

Approved by:

MILLER

Architectural Corporation

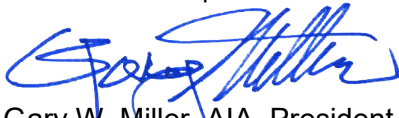

Gary W. Miller, AIA, President
(909) 335-7400 X 111

Signature

Date

2022 FEE SCHEDULE

MILLER ARCHITECTURAL CORPORATION
1177 IDAHO STREET, SUITE 200
REDLANDS, CA 92374
P 909.335.7400 F 909.335.7299

PROFESSIONAL AND TECHNICAL STAFF:

Senior Principal	\$242.00/hour
Court/Arbitration Appearance	\$289.00/hour
Deposition	\$315.00 - First Hour \$284.00 - Each Additional Hour
Principal (Architecture Division)	\$186.00/hour
Associate (Architecture Division)	\$163.00/hour
Principal (Interiors Division)	\$158.00/hour
Senior Project Manager	\$145.00/hour
Project Manager	\$135.00/hour
Senior Technician	\$126.00/hour
Intermediate Technician	\$88.00/hour
Senior Clerk/Executive Assistant/Office Mgr.	\$87.00/hour
Junior Technician	\$79.00/hour
Administrative Assistant/Marketing Assistant	\$84.00/hour
Secretarial/Clerical/Intern	\$65.00/hour
Archive Retrieval Fee	\$210.00/Flat Fee
Drone Photography/Remote Aerial Survey	\$263.00/hour

Overtime for hourly personnel will be charged at the base rate of 1.5 per hour for time in excess of 8 hours per weekday or for work on Saturdays, Sundays and holidays.

EXPENSES:

- Out of pocket expenses, (i.e. photocopies, film development, shipping, blueprints): cost plus 15%.
- In-house Services:

Large Format	\$ 2.40 per 24" x 36" sheet
Black & White:	\$ 3.35 per 30" x 42" sheet
Large Format	\$7.10 per 24" x 36" sheet
Color:	\$9.20 per 30" x 42" sheet
Photo Copies:	Black & White: \$0.33 per 8-1/2" x 11" page
	Black & White: \$0.56 per 11" x 17" page
	Color: \$1.82 per 8-1/2" x 11" page
	Color: \$3.10 per 11" x 17" page
	Black & White \$0.83 per 12" x 18" page
	Color \$3.65 per 12" x 18" page
Presentation Materials:	\$21.00 per 30 x 40 Foam Board
CD with Files:	\$52.00
Upload Data:	\$52.00
- Mileage: \$.70 per mile.
- For work which requires overnight lodging, a per diem charge will be made appropriate to the area, based on actual costs.
- Outside consultants not included in base fee and plan check fees shall be billed at direct cost plus 15%.

INVOICING

Invoices will be issued either monthly or bi-weekly and are due and payable upon receipt of the invoice, unless otherwise agreed. Interest of 1% per month, but not exceeding the maximum rate allowed by law, will be payable on any amounts not paid within 30 days. Payment thereafter is to be applied first to accrued interest and then to the principal unpaid amount. Attorney's fees or other cost incurred in collecting any delinquent amount shall be paid by the client.



**Request for Proposal
Architectural Services for
Design Concepts for
Building “C” Improvements**

West Valley Water District
September 6, 2022



1177 Idaho St. Suite 200
Redlands, CA 92374
Phone: 909-335-7400
Fax: 909-335-7299

Cover Letter

September 6, 2022

West Valley Water District
855 W. Base Line Road
Rialto, CA 92377

Re: **Architectural Services for Design Concepts for Building “C: Improvements**

Dear Mr. Bravo

Thank you for the opportunity to submit our qualifications for the above referenced project. We believe because of our current experience with Corporate Yard and Utility Department projects, extensive experience working with the City of Rialto makes us uniquely qualified to provide these services.

History of Firm

- **MILLER Architectural Corporation (MAC)** was founded in 1986 by Gary W. Miller and has been in business continuously for over 35 years. During that time we have provided architectural services for both the public and private sector.
- **Current number of employees** - 14 professionals and 2 support personnel in our California office. Work for this project will be performed from our Redlands office with support provided on an as needed basis from our Nevada and Utah offices.
- **MAC** is a highly professional, well balanced organization with **experienced personnel** in the fields of Architecture, Land Planning, Interior Design, Site and Building Evaluation, Master Planning and Construction Administration.

Project Scope

- We understand the scope of work for this project to entail the following services:
 - Architectural design concepts for renovations to an existing 5,000 SF metal Building “C” to serve the required use of Operations staff.
 - Building and facilities system assessment and recommended cost estimates to address priorities for the proposed building improvements for the facility at 855 West Base Line Road. to address facilities needs and meet conformance with all building and safety codes including required ADA improvements.

Service and Availability

- The MAC team is presently completing more projects than it is starting; therefore, we have staff available to immediately move on this project and produce them promptly.
- We have complete numerous project in and for the City of Rialto.
- Our corporate headquarters is located in Redlands which is within minutes to the project site. This positions us to respond quickly to your needs and enables us to be at the project site within a very short time.

Experience with Publicly funded Projects

- **MAC** constantly has at least one and usually many office and renovation projects on the boards. Issues that we are particularly sensitive to include:
 - Maintaining project budgets
 - Limiting scope creep (end users asking for more than budget allows)
 - Controlling the contractor and avoiding change orders during construction
 - We provide timely service and schedule compliance.



Experience With Capital Improvements and Publicly Bid Projects

- **MILLER Architectural Corporation (MAC)** is a highly professional, well balanced organization with a wide range of experience in nearly every type of building and structural system.
- MAC has a particularly strong resume in the following building types:
 - Office / Administration Buildings
 - Warehouses and Corporate Yards
 - Site Master Planning
 - Space Planning
- **Additions and Renovations / Demolition**
 - Throughout the years 60% of our work has been site and building evaluation, renovation and addition work.
 - Our extensive renovation experience has enabled us to develop specialized skills that are unique and necessary for a successful renovation project. These skills and services include:
 - Photographic documentation of the existing facility to ensure that all impacts of the addition/renovation are taken into consideration.
 - Thorough check list system to identify all items affected by renovation/addition projects.
 - Specialized cost estimating experience that is unique to renovation projects.
 - A keen eye developed from years of experience in identifying critical aspects of the site and building that impact demolition and renovation work.

City license and Evidence of Insurance

- All insurance criteria meets or exceeds the Agency requirements and will be provided to satisfy WVWD if selected for this project.
- City business license will be obtained is awarded this project to meet all City requirements.

RFP Acknowledgements

- I Gary W. Miller certify that the firm of Miller Architectural Corporation (**MAC**) is registered in the State of California and is licensed to perform architectural, engineering and construction services in the State of California and that the firm is not barred, suspended or otherwise prohibited from professional practice by any federal, state or local agency. We have no history of default, litigation settlements or judgments against our firm.
- **We accept the WVWD's Agreement for Professional Services, Insurance and Indemnity requirements.**
- We acknowledge that this proposal shall be valid for a period of 120 calendar days from the due date of the proposal.
- We acknowledge that there are no existing or potential conflicts of interest associated with this project.
- We acknowledge that all information submitted in this proposal is true and correct and that the signature of Gary W. Miller is the person authorized to bind consultants to the terms of any contracts which result from this submittal. **We acknowledge that there were no addenda issued for this project and that all items in the RFP have been included in the fee proposal.**
- Authorized Consultant for Contractual Terms and Conditions:
 - Miller Architectural Corporation
 - 1177 Idaho Street, Suite 200, Redlands, CA 92374
 - Phone: (909) 335-7400
 - Email: koswalt@miller-aip.com
 - Contact: Gary Miller – Principal (License C14635)
 - Federal Tax ID – 330355016

This team, headed by MAC can offer the more personal and hands on level of service that only a medium sized firm can offer. We have sufficient staff to respond with short notice to meet your needs and with a staff of 20 we are able to make people available quickly without overloading the firm. We feel confident that with our staff and team of experts for this project we can work seamlessly and hand in hand with your staff to assure a successful project. Our goal will be to meet the expectations of your staff and end users resulting in a project that is completed on time and within budget that will serve all of your needs for years to come. Thank you for your consideration.

Sincerely,

MILLER Architectural Corporation



Gary W. Miller
AIA, President

Table of Contents

Cover Letter

Executive Summary 2

Qualification..... 3-4

Relevant Projects5

Scope of Services

Detailed Project Approach and Work Plan6-7

Key Personnel

Miller Architectural Team Resumes8-9



Executive Summary

Executive Summary

Skills required for Renovation Design and Adaptive Reuse Projects

- Renovation and adaptive reuse projects typically require a variety of skills. In addition to traditional architectural skills, we offer: Building and building system evaluation, initial budget estimating, ADA assessments, roofing consulting, interior design, space planning, and project management. Our experience has shown that the following skills and experience benefit this kind of contract.
 - a. Renovation experience
 - b. Small scope of work project experience
 - c. Experience in a variety of building types and building uses
 - d. A network of consultants to meet the skill required for all types of work

Service and Availability

- The MAC team is presently completing more projects than it is starting; therefore, we have sufficient staff to immediately move on project and produce them promptly.
- Our corporate headquarters is located in Redlands which is about 10 minutes from the cities main offices and most potential project sites. This positions us to respond quickly to WVWD staff and enables us to be at most project sites within a very short period of time.

This team, headed by the medium sized firm of MAC can offer the more personal and hands on level of service that only a medium sized firm can offer. We have sufficient staff to respond with short notice to your needs and with a staff of 20 we are able to make people available quickly without overloading the firm. Our size is large enough to serve major projects yet the staff is all experienced in projects that have been as small in scale as \$60,000.00 in construction costs.

Proposed Scope

- The MAC motto is **VISION TO REALITY**. Our goal is to **capture your vision** and bring it into an **affordable, functional, and enriching reality**. In order to accomplish this goal we must become part of your team. We must listen and ask questions to fully understand your philosophy, goals, needs, preferences and priorities. Once our understanding is parallel with yours, we apply our skills to accomplish your goals and make this **building meet your desired needs**. We intend to achieve these goals by providing the following:
 - **RESEARCH AND PROGRAMMING**
 - **ASSESSMENT- ASSESS CONDITION OF THE SITE AND PROPOSED FACILITY NEEDS**
 - **EARLY COST ESTIMATE**
 - **SPACE PLANNING**
 - **SPACE PLANNING**
- **The ultimate goals is to** develop design concepts that present the best options in meeting the design objectives and prepare conceptual floor plans consistent with the agreed objectives and priorities.



Qualifications

FIRM HISTORY

- MILLER Architectural Corporation (**MAC**) (formerly GMID) has provided architectural services for Local Government agencies for the entire history of the firm. Agencies served include the City of San Bernardino for 20 years, County of San Bernardino for 30 years, County of Riverside for 20 years and multiple other local municipalities. We encourage you to seek input from County personnel familiar with our work and are confident you will receive favorable reports of our work.
- Since its inception in 1986 MAC has enjoyed consistent growth to reach its current staff level of 20 with 16 of those located in our Redlands, CA office. Personnel consist of 4 architects, 5 project managers, 4 technicians, 1 interior designer and 2 administrative/clerical personnel. This medium size assures you personal attention of the owner, stability in the staffing of your project and excellent quality in the people assigned to your project. Many of our staff have been with us since the very early days of the company.
- MAC is a highly professional, well balanced organization with experienced personnel in the fields of Architecture, Land Planning, Interior Design, LEED qualifying buildings, Site and Building Evaluation, Master Planning and Construction Administration.
- Our reputation has been built by respecting your needs and priorities, and blending creative ability with practical skills.
- MAC does not have any outstanding or proposed commitments that will impact our ability to perform this agreement.

EXPERIENCE REQUIRED FOR ADMINISTRATIVE OFFICE & SITE ASSESSMENT

- Each member of the team has considerable experience with multiple building type.
- The work our office has provided have involved new structures, additions, renovation and reuse. Over 50% of our firms work load year to year has been building evaluation, renovation and addition work. As a result of this extensive experience we have developed systematic methods to assure the project avoids pitfalls common in the design of new and renovation construction. This system includes:
 - Survey checklists to identify all building components affected by the project.
 - Thorough documentation of existing conditions prior to start of construction
 - Properly phasing the work to allow maximum building usage and minimizing the disruption to operations.
- Renovation projects typically require a variety of skills. In addition to traditional skills, in-house skills offered by our office include:
 - Site and building system evaluation
 - Initial budget estimating
 - ADA assessments
 - Roofing consulting
 - Interior Design
 - Movable systems furniture layout and specifications
 - Project Management
- One important aspect of renovation and addition work is performing the construction process while keeping operations going. This requires extensive knowledge in construction methods, and realistic scheduling. Many of our projects have been completed while operations continued. We can make it happen.

EXPERIENCE WITH CAPITAL IMPROVEMENT AND PUBLICLY BID PROJECTS

- MAC consistently has at least one and often many public projects on the boards.
- We have experience in designing buildings which house multiple uses or multiple departments.
- We are skilled at bringing different departments together in a spirit of cooperation
- We have been involved in all aspects of publicly funded work. This includes when there has been money available from other sources outside the City.
- We have tools that help departments and agencies arrive at a consensus of opinion
- Issues to which we are particularly sensitivity include:
 - Maintaining Budgets.
 - Limiting scope creep (end users asking for more than budget allows)



Qualifications

- Maintain the authority of the Project Manager while serving the need of the client
 - Avoiding change orders
 - Controlling construction schedule and quality
- We have made it a policy to keep our practice diverse. Thus it is safe to say that it is unlikely that there is a building type that we have not designed. We are also familiar with every type of construction method to be encountered. A partial list of building types we have completed includes:
 - Office Buildings
 - Additions / Renovations
 - Utility Company
 - City Yards
- We offer a solid reputation for quality service, timely performance, within budget, and a minimum of change orders during construction.

PROJECT TEAM QUALIFICATIONS AND EXPERIENCE

- It is our policy to assign a design team to each project. The Key personnel assigned to the project are as indicated on the attached organization chart and will be available for the duration of the project and no person that is designated as “key” personnel shall be removed or replaced without the prior written concurrence of the Owner’s representative. The team follows the project from the beginning to the end. The benefits of such an arrangement are:
 - The client deals with the same individuals for all phases of the project
 - The client knows who is directly responsible for the progress of the project.
 - An uninterrupted flow of information is maintained, thus reducing the possibilities for lost and misinterpreted project data.
- When addressing the assessment and renovation of the existing facility these type projects require consultants who are willing to roll up their sleeves, crawl into the attic, take off electrical panel covers and evaluate the condition of existing air conditioning equipment. We have that consultant network in place and have a long history of working together on these type projects. These consultants understand our methods, enabling us to provide quick response for the completion of projects. With the expertise of our structural, mech., and elect. consultants to evaluate the facility requirements and review and assist with the design and programming the project will be assured of a well rounded project with all of the necessary elements required to assure a complete and thorough set of construction documents.

ABILITY AND COMMITMENT TO SUCCESSFULLY COMPLETE A PROJECT WITHIN BUDGET, SCHEDULE AND SCOPE

- The MAC design team has a long history of completing projects within budget, schedule and scope
- Critical path schedules are required for our services for contractor’s work
- We have completed design and construction documents for private sector projects within 6 weeks of receiving notice to proceed
- Our government projects have an enviable history of timely completion also
- We can perform cost estimates in house and have a reliable data base of construction costs especially for buildings of this size.
- Our office uses three different cost estimating methods depending on the nature of the project.. In-house estimating, estimating services, (seldom any more reliable than our in-house estimates) and contractor and subcontractor input. These three sources enable us to catch oversights from any of the three methods.



Relevant Projects

PROJECT NAME LOCATION	DESIGN SCOPE	COST
Rialto Public Works Administration Facility Rialto, CA	8,640 SF renovation of fire damage facility. Improvements included removal and replacement of fire damage trusses and reroof. Entire building provided with tenant Improvement, programming and space planning for office layout which include lobby, reception, admin. offices, conference room, break room and ADA restroom improvements. Exterior improvements to include ADA path of travel from public way to building entry and ADA accessible parking with path of travel to entrance. Building to be upgraded with Fire sprinkler system.	In Design
San Bernardino Valley Municipal Water District Headquarters San Bernardino, CA	<ul style="list-style-type: none"> • 16,000 SF office building (masonry construction) • 10,000 SF operations building 	\$5,850,000
Southwest Gas Administration & Operations Center Victorville, CA	<ul style="list-style-type: none"> • 20,000 SF Administration Office Building • 20,000 SF Operations Center 	\$12,000,000
San Bernardino Municipal Water Department San Bernardino	<ul style="list-style-type: none"> • 7,550 SF Office Tenant Improvement • 1,375 SF Addition 	4,200,000
Riverside Highland Water District Corporate HQ Grand Terrace, CA	<ul style="list-style-type: none"> • 5,600 SF admin office building • 3,828 SF operations building • 2,852 SF vehicle storage building 	\$2,000,000
East Valley Water District Corporate Headquarters San Bernardino, CA	<ul style="list-style-type: none"> • 25,000 SF office building steel frame • 8,000 SF operations bldg steel frame, • 5,000 SF vehicle maintenance bldg • 8,000 SF warehouse (pre-eng) 	\$20,000,000
IVDA Admin Headquarters San Bernardino International Airport San Bernardino, CA	<ul style="list-style-type: none"> • 28,000 SF one-story renovation (existing CMU block building) to provide council chamber, admin offices, and meeting room facilities LEED Silver 	\$3,800,000
RC Construction Administrative Offices, Shops and Storage	<ul style="list-style-type: none"> • 20,000 SF office (tilt-up concrete) • 10,000 SF shops (tilt-up concrete) • 80,000 SF storage (pre-engineered metal) 	\$6,360,000
Social Security Administration Office of Hearing & Appeals San Bernardino, CA	<ul style="list-style-type: none"> • Programming, space planning and construction documents for a 44,700 SF, 2 story office building consisting of administrative offices, Hearing & Appeals courtrooms and judges chambers 	\$4,025,000
Chino Hills City Yard Chino, CA	<ul style="list-style-type: none"> • 13,000 SF renovation for city yard administration and maintenance offices (4.6 acre master plan and design documents) 	\$1,200,000
San Bernardino County Superintendent Schools Administration Offices San Bernardino, CA	<ul style="list-style-type: none"> • Architectural analysis and survey of existing conditions for needs assessment and ADA compliance for two existing office building to house administrative function for the Superintendent of Schools. Tenant Improvement, programming and space planning for office layout for two 50,000 SF buildings to include lobby, reception, admin. offices, training facility, registration center, conference rooms, breakroom and ADA improvements. 	\$5,000,000
Norco City Hall /Sheriff Expansion Norco, CA	<ul style="list-style-type: none"> • 28,000 SF of tenant Improvement, programming and space planning for office layout to include expansion of Sheriff Dept, front lobby and reception area, admin. offices, conference room, break room, locker rooms and ADA restrooms 	\$915,000

Detailed Project Approach and Work Plan

DETAILED PROJECT APPROACH & WORK PLAN

PHILOSOPHY

The MAC motto is **VISION TO REALITY**. Our goal is to **capture your vision** and bring it into an **affordable, functional, and enriching reality**. In order to accomplish this goal we must become part of your team. We must listen and ask questions to fully understand your philosophy, goals, needs, preferences and priorities. Once our understanding is parallel with yours, we apply our skills to accomplish your goals and make this **your building**.

OVERALL PROJECT GOALS & GENERAL PROCEEDURES

- **The overall purpose of this project approach is to provide every service listed in the Scope of Work section of the Request for Proposal.**
- **Meet** with staff to establish the end purpose of the work
- **Confirm** mission statement, and how this project fits with short and long term goals.
- Maximize **Cooperative Team Effort** to understand and attain project goals
- Understand the philosophy behind the program
- **Shepherd the Process/Push the Schedule**
 - The data collection and evaluation process can easily become bogged down by indecision and over analysis. We will apply management techniques that assure decisions are made promptly and finally, also to point out the consequences of each decision.
 - Aid the Decision Making Process
 - Offer **graphically clear data and cost estimate options** that:
 - Clearly illustrate the options and individual benefits
 - Chart the benefits and disadvantages of each option
 - Illustrate budget impacts
- Thoroughly consider all facility use options to meet the facility needs

PROJECT INITIATION/ PREPARATION

- Establish a line of authority and who is authorized to make decisions for the City
- The **MAC** Design Team will meet with the owner's representative to accomplish the following:
 - Establish communication procedures & line of authority
 - Acquire an understanding of the programmatic requirements.
 - Plot a timeline to ensure that goals are being met
- Research code and local agency requirements and determine their effect on the project
- Using our expertise in facility needs assessment review the following:
 - Review current space usage
 - Review current and perceived future space needs based upon current / future employee needs
 - Review and determine if there are any amenities and building features that need to be incorporated into the project.
 - Review compliance with current code including the American's with Disability Act

RESEARCH/PROGRAMMING

- **MAC** and the project team will seek to fully understand the goals and priorities of the project team and then adopt those goals and priorities as our own
- As a project team refine the program to the satisfaction of the Department.
- **MAC** will thoroughly review and become familiar with Department operations, policies, & design goals.

Detailed Project Approach and Work Plan

ASSESSMENT- ASSESS CONDITION OF THE SITE AND PROPOSED FACILITY NEEDS

- **MAC** suggests that assessment of existing conditions of site and building be conducted first to provide a basis of information to help guide the programming phase.
- Employ a systematic evaluation system that has been developed from years of experience in evaluating facility and site needs and requirements.
- Assure that all areas listed in the RFP are addressed.
- Survey checklists to identify and categorize all site required components as follows:
 - Site
 - Accessibility compliance
 - Code compliance
 - Exiting requirements
 - Accessibility (ADA)
 - Allowable occupancy and allowable uses
 - Construction type and the impacts
 - Occupancy
 - Building materials
 - Structural systems
 - Mechanical / Plumbing / Electrical
 - Method of providing fire protection
 - Energy efficiency of the building shell
- Review existing facility to determine extent of potential improvements. Based upon preliminary review of the facility the following items will need to be addressed and will be surveyed with a checklist to identify and categorize the building components as follows:
 - Assessment and replacement of mechanical equipment and systems
 - Assessment and replacement of electrical wiring and lighting with Code compliant LED fixtures and controls
 - Review and assessment of wall, ceilings and insulation systems to determine extent of removal and replacement of components.

EARLY COST ESTIMATE

- Using accepted industry data base provide rough order of magnitude costs for facility improvements and renovation of the existing fire damaged facility
- Use cost estimating as a tool to determine the necessary funding required to assure that appropriate funding is in place or that scope of work is adjusted to meet the anticipated budget
- Confirm that Department accepts this early estimate.

SPACE PLANNING

- Provide all services as required for **Architectural Space Program Phase**
- Inventory existing space, furniture and equipment and assess it's potential for reuse or repurposing.
- Using established industry standards, existing data, interviews, space assessments, and future projections and in cooperation with Department Leadership develop job description categories, space classifications, and functions.
- Develop standards for each space classification. Standards shall include recommended room size, layout, furniture, equipment, preferred lighting, power and communication needs.
- Develop a proximity matrix for spaces and for exterior access and lighting
- Provide a projection of future space needs based upon a 20 years long range plan
- Identify opportunities to efficiently optimize use of current space
- Based upon needs assessment prepare prioritized recommendations for development of facility
- Provide a written report listing the needs as described above.
- Review the report with Department Staff, modify as appropriate
- Present the Final Architectural Space Program recommendations to the Department. Once approved by the Department this will serve as the basis for design.

SCHEMATIC DESIGN

- Provide all services required for **Schematic Design Phase**
- Develop design concepts that present the best options in meeting the design objectives
- Prepare conceptual floor plans consistent with the agreed objectives and priorities.
- Modify design as directed
- Obtain Department's approval of the schematic design

Miller Architectural Corporation Resumes

EDUCATION:

- Cal State Polytechnic Bachelor of Architecture

PROFESSIONAL:

- Licensed Architect State of California License #C14635
- State of Utah License #280768-0301
- State of Arizona License #26672
- State of Wyoming License #C-1695
- State of Idaho License #AR-2527

PROFESSIONAL/ COMMUNITY MEMBERSHIP:

- American Institute of Architects
- Inland California Chapter American Institute of Architects
- Interfaith Forum on Religion, Art & Architecture
- National Council of Architectural Registration Boards
- Local Planning Commissioner
- National Trust for Historic Preservation
- Boy Scouts of America former district chairman, scout master and other positions

LEED EXPERIENCE

- Riverside County Library, LEED Silver Certified



GARY MILLER President, CEO, Principal in Charge

Gary Miller, President and CEO of MILLER-AIP has over 45 years in the architectural arena. His high impact, cost effective designs have set MILLER-AIP apart from other architects. Strict adherence to client priorities and program requirements is a hallmark of Mr. Millers approach. A "hands on" approach and lengthy experience has resulted in satisfied and repeat clients. He has final responsibility to assure the goals and quality standards are achieved.



Relevant Experience:

- **San Bernardino Water Department, San Bernardino, CA:** Renovation of 16,000 SF office building and 10,000 operations building including masonry construction
- **Southwest Gas Corp. Operation Center, Victorville, CA:** 40,000 SF Operation Center and Warehouse Facility and Masterplan
- **East Valley Water District, San Bernardino, CA:** 25,000 SF Administration Facility, 8,000 SF Operation building, 8,000 SF Warehouse and 5,000 Sf Maintenance Building. Designed for LEED silver
- **Joshua Tree Administration Building, Joshua Tree, CA:** 29,500 sf Administration building with future 10,000 sf expansion capabilities containing 5 county agencies with LEED silver certified.
- **County of Riverside Mental Health Treatment Facility, Indio, CA:** Feasibility study of current building and recommendations for expansion
- **Arrowhead Orthopedics, Riverside, CA:** 3 suites totaling 49,000 SF
- **Riverside Highland Water District, Grand Terrace, CA:** 6,500 SF administrative office building, 3,828 SF operations building and 2,852 SF vehicle storage building
- **S.B. Co Health Department:** 4,800 SF Tenant Improvement Space planning for office layout to include lobby, reception area, admin. offices, break room and ADA restroom
- **San Bernardino Welfare Services, San Bernardino, CA:** Restroom remodel for A.D.A. compliance
- **San Bernardino Health Dept.:** 6,435 SF T.I. to include office space for three County departments and restroom remodel
- **Housing Authority of San Bernardino, San Bernardino, CA:** 19,500 SF 1 story administrative office building, with social service functions, concrete tilt up
- **San Bernardino County Medical Society, Colton, CA:** 24,000 SF Office building, major tenant Improvements required a high degree of electronic communications and record storage.
- **Immigration & Naturalization Services, San Bernardino, CA:** 80,000 SF offices, detention areas, sally port, public waiting & info area. Programming, space planning & construction documents
- **LEED Silver Certified Riverside County Library – \$2,800,000, 7,671 SF** one story wood frame library and community room. Minimized staff by making public space easily supervised by one central station, constructed of durable finishes to increase longevity of the building.

Miller Architectural Corporation Resumes

PROFESSIONAL/
COMMUNITY

MEMBERSHIP:

International Code
Council

- American Institute of
Architects

- Southern California
Association of Forest-
ers and Fire Wardens

EDUCATION:

Cal State

San Bernardino,

Bachelor of Arts

GLEN FOLLETT**Principal in Charge of Production/Quality
Control**

Glen Follett has over 40 years of Architectural and construction experience. As a long time member of the ICC Glen has become an expert in code interpretation. As director of production Mr. Follett has developed document standards and quality control protocols that have been adopted by other offices throughout the western United States.

**Relevant Experience:**

- **Riverside Highland Water District, Riverside, CA:** 5,600 SF Admin. offices, 3,800 SF Operations building and 2,900 SF vehicle storage
- **SB County INS Homeland Security, San Bernardino, CA:** 60,357 SF building including offices, interview rooms, conference rooms and secured sally port.
- **Remax Office, Valencia, CA:** Two story 24,000 SF building with parking structure.
- **Granum/IRC Office, San Bernardino, CA:** Two story 51,700 SF office bldg.
- **Granum/Hardt Street Office, San Bernardino, CA:** Two story 39,024 SF office.
- **Feldkamp Office Building, San Bernardino, CA:** Three story 20,532 SF office
- **Mt. West Financial Corp. Headquarters, Redlands, CA:** Two story 45,000 SF
- **Highgrove Library, Riverside, CA:** 7,500 SF library w/community room. LEED Silver

KATHLEEN M. OSWALT
Senior Project Manager

Kathleen Oswalt brings 40 years in the field of architecture with experience in planning and agency coordination, project scheduling, client negotiation and interaction, team organization, construction document preparation, project management, bid phase and Construction administration.

**Relevant Experience:**

- **Rialto Public Works Administration, Rialto, CA:** 10,000 SF Facility Repair and Renovation
- **San Bernardino Unified School District Administration, San Bernardino, CA:** 32,670 SF of tenant improvements and renovation for main administration offices
- **Norco City Hall/Sheriff Expansion, Norco, CA:** 28,000 sq. ft. tenant improvement and exterior upgrades
- **Pro-Craft Construction, Redlands, CA:** 20,000 SF Corporate Headquarter Tenant Improvement
- **Co. of SB Public Health Dept. FSS/CAH, San Bernardino, CA:** 23,235 SF of tenant Improvement for main offices and central conferencing center
- **Chino Corporate Yard, Chino, CA:** 7,000 sq. ft addition and 15,000 sq. ft. renovation
- **Loma Linda Civic Center, Loma Linda, CA:** New Library, Fire Station, Council Chambers & Conference rooms
- **Lucerne Valley Library, Lucerne, CA:** Library & Community Center





**BOARD OF DIRECTORS
STAFF REPORT**

DATE: October 20, 2022
TO: Board of Directors
FROM: Van Jew, Acting General Manager
SUBJECT: ULTRAVIOLET TRANSMITTANCE METER FOR THE OLIVER P. ROEMER WATER FILTRATION PLANT

BACKGROUND:

District staff has identified a need to replace a malfunctioned ultraviolet transmittance (UVT) meter with Trojan Technologies for the ultraviolet disinfection (UV) system at the Oliver P. Roemer Water Filtration (Roemer) Plant. The Roemer Plant utilizes coagulation, contact clarification, filtration, and post filtration process including a UV system, Granular Activated Carbon (GAC), and chlorine disinfection. Filtered water is disinfected by UV reactors as primary disinfection before going to the GAC vessels for total organic carbon (TOC) removal. Finally, water leaving the GAC vessels is delivered to a water storage basin for secondary disinfection.

The UV system at the Roemer Plant is manufactured by Trojan Technologies.

DISCUSSION:

Trojan Technologies is the manufacturer of Trojan UV systems. Attached as **Exhibit A** is the Sole Source Letter. The total cost for the UVT is \$12,100.33. Attached as **Exhibit B** is the Quote. Staff is recommending a purchase order be issued to Trojan Technologies in the amount of \$12,500.00 to account for other Trojan parts and a slight contingency for unforeseens.

FISCAL IMPACT:

This item is included in the Fiscal Year 2022/23 Operating Budget and will be funded from project number GL100-5390-525-5340 titled "Professional Services/Other Consultants".

STAFF RECOMMENDATION:

Staff recommends that the Board of Directors to issue a Purchase Order in the amount not to exceed \$12,500.00 for a UVT meter from Trojan Technologies.

Respectfully Submitted,

Van Jew

Van Jew, Acting General Manager

VJ:jc

ATTACHMENT(S):

1. Exhibit A - Sole Source Letter
2. Exhibit B - Quote

MEETING HISTORY:

10/12/22 Engineering, Operations and Planning Committee REFERRED TO BOARD

Exhibit A

TROJAN W.

WATER CONFIDENCE"

July 20, 2020

West Valley Water District
Attn: Sergio Granda
3010 N. Cedar Avenue
Rialto, CA 92376

RE: Trojan System UV Swift™
Trojan Serial #710084

Dear Mr. Granda,

In the Engineered Submittal Package for the Trojan UVSwift™ System, Trojan provided an equipment performance guarantee stating that the system will meet the required level of disinfection provided that the system is operated and maintained in accordance with recommendations made by Trojan Technologies.

In order for this equipment guarantee to be maintained, it is imperative that the appropriate components and replacement parts be used in the system. There are key replacement parts and system components that directly influence the performance and reliability of the system. Among these critical replacement parts are the UV lamps, electronic ballasts, printed circuitry etc. Without using lamps, ballasts, and other components that are approved and validated by Trojan Technologies, we cannot guarantee that the system will provide the required germicidal output. Subsequently, we cannot guarantee that the required UV dose is being delivered.

In order to keep the equipment performance guarantee intact, it is recommended that specialized system components be purchased and contracted from our manufacturer representative in your state. In the State of California, the exclusive manufacturer representative is DC Frost & Associates, Inc., a wholly owned subsidiary of the Coombs-Hopkins Company. Trojan purchases only validated system components (lamps, ballasts etc.) from our suppliers and only those components meeting our performance standards are passed on to the customer.

If you have any questions regarding this matter or require any additional information, please do not hesitate to our office at 1-800-291-0218.

Best regards,
TROJAN TECHNOLOGIES

Judy Georg•ije..æ

Judy Georgijev
Municipal Territory Representative

TROJAN TECHNOLOGIES 3020 GORE ROAD LONDON, ONTARIO CANADA NSV 4T7 T 519 457.3400 F 457 3030 WWW.TROJANUV.COM

Exhibit B

QUOTATION
QO0001411



TROJAN TECHNOLOGIES
3020 GORE ROAD
LONDON, ON N5V 4T7
CANADA
T. 519-457-3400
www.trojantechnologies.com

Sold to
WEST VALLEY WATER DISTRICT
PO BOX 920
Rialto CA 92377-0920
UNITED STATES

Ship to
WEST VALLEY WATER DISTRICT
855 W. BASELINE ROAD
Rialto CA 92376-3103
UNITED STATES

Customer Service Contact : tuvcustomerservice@trojantechnologies.com
Payment Terms : 0% / 00 / 30 net Internal Sales Rep : HEATHER WILCOX
Delivery Terms : Customer No. : 100003960
Carrier/LSP : Reference : Detection assembly
Quote Date : 09-27-2022
Quote Expiry Date : 10-27-2022

Line	Project Item Description	Quantity	Price Discount %		Unit Net Price Net Amount	Tax Rate Tax Amount	Amount
10	905307 DETECTION ASSY, ONLINE UVT	1.00	10,730.00/	EA	10,730.00 10,730.00	7.75% 831.58	11,561.58
20	FREIGHT FREIGHT & HANDLING	1.00	500.00/	EA	500.00 500.00	7.75% 38.75	538.75
Estimate for budgeting							

Goods	10,730.00	Discount	0.00	Tax Amount		Total USD
Costs	500.00	Subtotal	11,230.00	870.33		12,100.33



TROJAN TECHNOLOGIES
 3020 GORE ROAD
 LONDON, ON N5V 4T7
 CANADA
 T. 519-457-3400
www.trojantechnologies.com

Terms and Conditions

All purchases of Trojan products and/or services are expressly and without limitation subject to Trojan's Terms and Conditions of Sale ("Trojan" or "SELLER"), incorporated herein by reference and published on Trojan's website <https://www.trojantechnologies.com/sales-terms-conditions/>

Trojan TCS are incorporated by reference into each of Trojan's offers or quotations, order acknowledgments, and invoice and shipping documents. The first of the following acts shall constitute an acceptance of Trojan's offer and not a counteroffer and shall create a contract of sale ("Contract") in accordance with the Trojan TCS, subject to Trojan's final credit approval: (i) Buyer's issuance of a purchase order document against Trojan's offer or quotation; (ii) Trojan's acknowledgement of Buyer's order; or (iii) commencement of any performance by Trojan in response to Buyer's order. Provisions contained in Buyer's purchase documents that materially alter, add to or subtract from the provisions of the Trojan's TCS shall be null and void and not considered part of the Contract.

www.trojantechnologies.com/sales-terms-conditions





**BOARD OF DIRECTORS
STAFF REPORT**

DATE: October 20, 2022
TO: Board of Directors
FROM: Van Jew, Acting General Manager
SUBJECT: POST WATER-MAIN BREAK STREET REPAIRS

BACKGROUND:

On September 21, 2022, a main break of an 8” polyvinyl chloride (PVC) waterline occurred on Calle Vista Drive in the City of Rialto. This led to a substantial amount of water loss that resulted in major damage to the street. The waterline has been repaired and temporary asphalt has been installed by District staff; however, a section, 33-feet x 93-feet, of the street will need to be repaired and paved to the City of Rialto standards. Photographs of the damage are attached as **Exhibit A**.

The scope of work consists of removing 3,069 square feet of existing and temporary asphalt 8.5 to 10 inches deep, installing 6 inches of aggregate base and 2.5 inches of asphalt, performing soil compaction testing, capping with 1.5 inches of thick asphalt, and providing traffic control.

DISCUSSION:

The District’s street paving contractor, Mike Roquet Construction Inc., submitted a quote in the amount of \$56,522.00 (**Exhibit B**). Staff is recommending a purchase order be issued to Mike Roquet Construction Inc. in the amount of \$60,000.00 to account for payment and performance bonds and a slight contingency for unforeseens.

FISCAL IMPACT:

This item is included in the Fiscal Year 2022/23 Operating Budget and will be funded from project number GL100-5410-540-5612.

STAFF RECOMMENDATION:

Staff recommends that the Board of Directors to issue a purchase order in the amount of \$60,000.000 to Mike Roquet Construction Inc. for post water-main break street repairs.

Respectfully Submitted,

Van Jew

Van Jew, Acting General Manager

VJ;jc

ATTACHMENT(S):

1. Exhibit A - Photo
2. Exhibit B - Quote

MEETING HISTORY:

10/12/22 Engineering, Operations and Planning Committee REFERRED TO BOARD

EXHIBIT A



EXHIBIT B



P.O. Box 539
Highland, CA 92346
(951) 533-3797
Lic #1007568

PROPOSAL

To:

Page 1 of 1 September 23, 2022

West Valley Water District

855 W. Baseline Rd.

Rialto, CA 92376

(909) 875-1804

JOB LOCATION: 2419 CALLE VISTA DRIVE, RIALTO

We hereby submit specifications and estimates for:

Item *total*

STREET REPAIR:

First move-in:

1. Remove existing asphalt and subbase material to a depth of 10" below finished surface elevation at one area (33' x 93') totaling 3,069 sq. ft.
2. Haul away asphalt and subbase material to a legal disposal site.
3. Compact 3,069 sq. ft. of subgrade area by rolling with a vibratory roller.
4. Install 6" thick class II (crushed miscellaneous base) on 3,069 sq. ft.
5. Fine-grade and compact 3,069 sq. ft. of class II base.
6. Base-pave 3,069 sq. ft. with 2.5" of asphalt (3/4" mix for strength).
7. Furnish and provide a geotechnical engineer for compaction testing on subgrade, class II base material, asphalt base course, and final asphalt cap.

Second move-in (1 – 2 weeks later):

8. Header grind and feather where new asphalt joins existing; then clean, tack, and cap 3,069 sq. ft. with 1.5" thick asphalt (1/2" mix).

Lump sum: \$54,522.00

Optional price:

1. Provide and set up traffic devices for street closure: \$2,000.00

GENERAL CONDITIONS:

- Two equipment moves are included. Street to remain closed during construction.
- Price includes prevailing wages.
- **EXCLUSIONS:** permits, fees, engineering, staking, water costs, water meter, seal coats, damage to buried objects not visible from the surface, over-excavation of subgrade for any reason, relocating utilities, disconnecting or handling utilities.
- Proposal good for 60 days from the date of issue.
- Any attorney fees, costs, or other expenses which may be incurred in the collection of monies as may become due under this contract or enforcement of the terms of this contract will be paid for by the customer.
- Unless otherwise herein provided, this contract shall be due and payable at Mike Roquet Construction Inc., P.O. Box 539, Highland, CA 92346 within 10 days from date of invoice.

AMOUNT: Fifty-four thousand, five hundred and twenty-two dollars and no cents (\$54,522.00)

Mike Roquet

President

Mike Roquet Construction Inc.



**BOARD OF DIRECTORS
STAFF REPORT**

DATE: October 20, 2022
TO: Board of Directors
FROM: Van Jew, Acting General Manager
SUBJECT: DISPOSABLE CARTRIDGE FILTERS FOR ION EXCHANGE
 TREATMENT SYSTEMS

BACKGROUND:

West Valley Water District's (District) six Ion Exchange Treatment Systems are equipped with a filter to prevent sand or silt from the source wells from getting into the bed of Ion Exchange Resin and causing flow restrictions. Production Division operates and maintains four of the six sites, while Treatment Division operates and maintains the remaining 2 sites. Restrictions in flow caused by sand/silt cannot be removed or separated from the resin bed and require replacement of the resin to remedy.

DISCUSSION:

The filters used for the District's Ion Exchange Treatment Systems use disposable cartridges which must be replaced periodically, in some cases several times per year, and each replacement uses 9-13 cartridges depending on the well sites. The Harmsco filters used by the District require Harmsco brand cartridges to maintain the NSF-61 rating required by the State Water Resources Control Board.

The quote for 240 cartridge filters from Harmsco totaled to \$42,377.22. The quote is good for 30 days from September 14, 2022 and the lead time is approximately 30 days. Attached as **Exhibit A** is the email quote. Staff is recommending a purchase order be issued to Harmsco in the amount of \$45,000.00 to account for a slight contingency for unforeseens.

Note: When this item was presented to the Engineering, Operations, & Planning Committee on October 12, 2022, staff's initial recommendation was to purchase 120 units at a cost of \$21,188.61. In consideration of challenges related to the supply chain and on-going inflation, the Committee gave liberty to staff to consider recommending the purchase of a higher number of filters and upon such evaluation, staff is now recommending the purchase of 240 filters.

FISCAL IMPACT:

This item will be shared 50/50 between the Treatment and Production Departments, as both departments use these cartridges. Production – Repair & Maintenance / Structures / Facilities 100-

5210-540-5614, and Treatment – Repair & Maintenance / Structures / Facilities 100-5350-540-5614.

STAFF RECOMMENDATION:

Staff recommends that the Board of Directors to issue a purchase order in the amount of \$45,000.00 to Harmsco Filtration Products for cartridge filters.

Respectfully Submitted,

Van Jew

Van Jew, Acting General Manager

VJ:js

ATTACHMENT(S):

1. Exhibit A - Email Quote

MEETING HISTORY:

10/12/22 Engineering, Operations and Planning Committee REFERRED TO BOARD

EXHIBIT A

Joe Schaack

From: Joel Holzberg <jholzberg@harmsco.com>
Sent: Wednesday, September 14, 2022 11:41 AM
To: Joe Schaack
Subject: RE: NEW HARMSCO
Attachments: Price List IP effective August 1, 2022 Rev.8.3.xlsx; Contract West Valley Water Effective Aug 1, 2022.xlsx

Hi Joe,

No, we implemented another price increase effective 8-1-22 (please see attachments).

Best Regards,
 Joel Holzberg
 Sales & Technical Support
 800-327-3248
 561-845-2474(fax)
 email: JHOLZBERG@HARMSCO.COM



Please take a moment to view our animated video detailing the Hurricane's patented features. When it comes to price and performance, your best solution for liquid filtration challenges is Hurricane Filtration Technology.

<http://www.youtube.com/watch?v=-SM1glwYMrq> [youtube.com]

Note: This publication is to be used as a guide. The data within has been obtained from many sources and is considered to be accurate. Harmsco does not assume liability for the accuracy and/or completeness of this data. Changes to the data can be made without notification. Temperature, Pressure, Flow Rates, Differential Pressures, Chemical Combinations and other unknown factors can affect performance in unknown ways. **Limited Warranty:** Harmsco warrants their products to be free of material and workmanship defects. Determination of suitability of Harmsco products for uses and applications contemplated by Buyer shall be the sole responsibility of Buyer. The end user/installer/buyer shall be liable for the product's performance and suitability regarding their specific intended applications. End users should perform their own tests to determine suitability for each application.

From: Joe Schaack <JSchaack@wvwd.org>
Sent: Wednesday, September 14, 2022 12:24 PM
To: Joel Holzberg <jholzberg@harmsco.com>
Subject: RE: NEW HARMSCO

Hello Joel,

Is this pricing update from May of this year still the current pricing?

Thanks,

Joe Schaack
 Production Supervisor
 West Valley Water District
 Office: (909) 875-1804 Ext. 359
 Cell: (909) 936-4584

CustomerBuyGrp	Name	StockCode	Description	Price
00000000400230	WEST VALLEY WATER DISTRICT	HC/170-10.0	HURRICANE CARTRIDGE-10 MICRON	163.20
00000000400230	WEST VALLEY WATER DISTRICT	HC/170-20.0	HURRICANE CARTRIDGE-20 MICRON	163.20
00000000400230	WEST VALLEY WATER DISTRICT	HC/170-50.0	HURRICANE CARTRIDGE-50 MICRON	163.20



NOTICE:

This product is in accordance with NSF Standard 61 certifications **ONLY** when utilizing **GENUINE HARMSCO® NSF listed filter cartridges and replacement parts.**

Certified to ANSI-NSF 61

Using any replacement products other than **GENUINE HARMSCO®** will void the NSF Standard 61 certification of this unit.

Joe Schaack

From: Joel Holzberg <jholzberg@harmsco.com>
Sent: Thursday, September 15, 2022 5:36 AM
To: Joe Schaack
Subject: RE: NEW HARMSCO

Good morning Joe,

The freight charge for the 120 cartridges is \$1,604.61, and lead time would be approximately 3 weeks ARO.

Best Regards,
 Joel Holzberg
 Sales & Technical Support
 800-327-3248
 561-845-2474(fax)
 email: JHOLZBERG@HARMSCO.COM



Please take a moment to view our animated video detailing the Hurricane's patented features. When it comes to price and performance, your best solution for liquid filtration challenges is Hurricane Filtration Technology.

<http://www.youtube.com/watch?v=-SM1glwYMrq> [youtube.com]

Note: This publication is to be used as a guide. The data within has been obtained from many sources and is considered to be accurate. Harmsco does not assume liability for the accuracy and/or completeness of this data. Changes to the data can be made without notification. Temperature, Pressure, Flow Rates, Differential Pressures, Chemical Combinations and other unknown factors can affect performance in unknown ways. **Limited Warranty:** Harmsco warrants their products to be free of material and workmanship defects. Determination of suitability of Harmsco products for uses and applications contemplated by Buyer shall be the sole responsibility of Buyer. The end user/installer/buyer shall be liable for the product's performance and suitability regarding their specific intended applications. End users should perform their own tests to determine suitability for each application.

From: Joe Schaack <JSchaack@wvwd.org>
Sent: Wednesday, September 14, 2022 4:03 PM
To: Joel Holzberg <jholzberg@harmsco.com>
Subject: RE: NEW HARMSCO

Joel,

What would your current lead time and shipping cost be on an order of 120 cartridges?

Thanks,

Joe Schaack
 Production Supervisor
 West Valley Water District
 Office: (909) 875-1804 Ext. 359
 Cell: (909) 936-4584

From: Joel Holzberg <jholzberg@harmsco.com>
Sent: Wednesday, September 14, 2022 11:41 AM



**BOARD OF DIRECTORS
STAFF REPORT**

DATE: October 20, 2022
TO: Board of Directors
FROM: Van Jew, Acting General Manager
SUBJECT: WATER SUPPLY ASSESSMENT FOR PEPPER 210 COMMERCE CENTER

BACKGROUND:

On July 12, 2022, Carson BBC Logistics Center, LLC (“Developer”) submitted a request for West Valley Water District (“District”) to review a Water Supply Assessment (“WSA”) for its proposed project in the unincorporated San Bernardino County area, known as Pepper 210 Commerce Center (“Project”). The Project proposes a development that consists of a 101.3-acre site located north of Highland Avenue, at the terminus of Pepper Ave as shown in Exhibit A. The development plan includes two structures: a warehouse, distribution, and logistics building totaling 1,255,354 sf and a single-story office building totaling 2,100 sf. The project will require water for consumptive and sanitary purposes to support employees at the facility, provide fire protection and for irrigation of landscaped areas.

DISCUSSION:

The WSA is a necessary requirement for compliance with the California Environmental Quality Act (“CEQA”), furthermore, the California Water Code (Code) requires projects as defined in Section 10912 of the Code, to include a WSA in their environmental impact report. The WSA evaluates whether the total water supplies available during normal, single-dry, and multiple-dry water years projected within the latest adopted Urban Water Management Plan (“UWMP”) will meet the anticipated water demand associated with the particular project, in addition to the existing and planned future uses.

A “Project” in the Water Code means any of the following:

- 1) A proposed residential development of more than 500 dwelling units.
- 2) A proposed shopping center or business establishment employing more than 1,000 persons or having more than 500,000 square feet of floor space.
- 3) A proposed commercial office building employing more than 1,000 persons or having more than 250,000 square feet of floor space.
- 4) A proposed hotel or motel, or both, having more than 500 rooms.
- 5) A proposed industrial, manufacturing, or processing plant, or industrial park planned to house more than 1,000 persons, occupying more than 40 acres of land, or having more than 650,000 square feet of floor area.

- 6) A mixed-use project that includes one or more of the projects specified in this subdivision.
- 7) A project that would demand an amount of water equivalent to, or greater than, the amount of water required by a 500 dwelling unit project.

This development is considered a project as defined by the Water Code per item number 5 above. The Code states that the District shall determine whether the projected water demand associated with a proposed project was included as part of the most recently adopted UWMP, and if so, the District may incorporate the requested information from the UWMP in preparing the elements of the WSA.

UWMPs are prepared to support the District's long-term resource planning, and to ensure that adequate water supplies are available to meet existing and future water demands. The plans must be prepared every 5 years and submitted to the Department of Water Resources. The latest UWMP adopted by the District was the 2020 Upper Santa Ana River Watershed Integrated Regional Urban Water Management Plan ("IRUWMP"). The demand projections for water usage rates per acre were based on land use designations from City and County General Plans.

Attached as Exhibit B for your review is a WSA prepared by the Developer's consultant, Water Systems Consulting, Inc. The net water demand for this Project is anticipated to be 119-acre feet per year. The anticipated water demand associated with the Project has been accounted for in the most recently adopted IRUWMP and information from that plan was utilized in the preparation of this WSA.

As demonstrated in the 2020 IRUWMP, the water supply available in 20 years in a normal, single dry and multiple dry water years is sufficient to meet the projected net demand associated with the project

FISCAL IMPACT:

No fiscal impact at this time.

STAFF RECOMMENDATION:

Staff recommends that the Board of Directors to approve the Water Supply Assessment for Pepper Ave 210 and authorize the Acting General Manager to execute all related documents.

Respectfully Submitted,

Van Jew

Van Jew, Acting General Manager

DG:ls

ATTACHMENT(S):

1. Exhibit A - Aerial Map
2. Exhibit B - Water Supply Assessment for Pepper 210 Commerce Center

MEETING HISTORY:

10/12/22 Engineering, Operations and Planning Committee REFERRED TO BOARD

EXHIBIT A

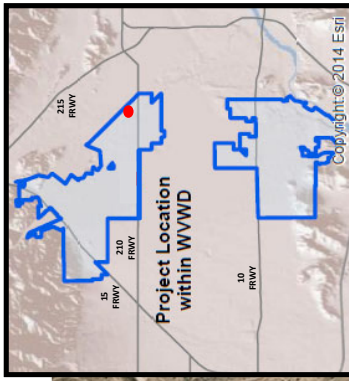

Exhibit A
Pepper 210 Commerce Center

EXHIBIT B

Draft Pepper 210 Commerce Center Water Supply Assessment

20080 North Highland Ave

SEPTEMBER 2022

PREPARED FOR WEST VALLEY WATER DISTRICT



Draft Pepper 210 Commerce Center Water Supply Assessment

20080 North Highland Ave

SEPTEMBER 2022

Prepared for



West Valley Water District Board Approved on **Date**
TBD

Prepared Under the Responsible Charge of:
Kirsten Plonka, PE
California R.C.E. No. 70746, Expires 6/30/2023

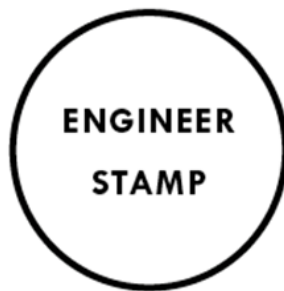

To be stamped upon finalization

Prepared by Water Systems Consulting, Inc



TABLE OF CONTENTS

Table of Contents.....	ii
List of Figures	iv
List of Tables	v
Acronyms & Abbreviations	vi
1.0 Introduction and Purpose	1-1
1.1 Legislation	1-2
1.2 Definitions.....	1-3
2.0 Public Water System Overview	2-1
2.1 Climate	2-3
2.2 Service Area Population	2-3
2.2.1 Other Demographic Factors.....	2-4
3.0 Project Description	3-1
4.0 Project Water Demand	4-1
4.1 Project Water Demand Projections	4-2
5.0 Water Supply Analysis.....	5-1
5.1 Water Sources	5-2
5.1.1 Purchased or Imported Water	5-2
5.1.2 Groundwater.....	5-2
5.1.3 Surface Water.....	5-7
5.2 Transfer Opportunities	5-7
5.3 Future Water Projects	5-7
5.4 Recycled Water	5-8
5.5 Water Supply Summary	5-8
5.6 Water Supply Reliability	5-11
6.0 Water Supply and Demand Analysis	6-1
7.0 Determination of Water Supply Sufficiency.....	7-1
7.1 Conditions of Approval.....	7-2
References	REF-1
Appendix A Lytle Creek Judgment & Surface Water Purchase Agreement	A
Appendix B Western Judgment	B
Appendix C Rialto Basin Decree.....	C
Appendix D Chino Basin Watermaster Judgment	D

Table of Contents

Appendix E Baseline Feeder Agreement..... E

LIST OF FIGURES

Figure 2-1. WVWD Service Area..... 2-2

Figure 2-2. Historical, Current and Projected Population Trends..... 2-4

Figure 3-1. Project Site Plan 3-2

Figure 3-2. Project Location 3-3

LIST OF TABLES

Table 2-1. Historical Temperature, Rainfall and Reference Evapotranspiration (ET _o) Data	2-3
Table 2-2. Historical, Current and Projected Population	2-4
Table 4-1. Project Demand, AFY	4-2
Table 4-2. Net Project Demand, AFY	4-2
Table 4-3. 2020 IRUWMP Projected Demand for Industrial Customers with the Addition of Net Project Demand	4-3
Table 5-1. Historical Groundwater Production, AFY	5-6
Table 5-2. Water Supplies – Historical, AFY	5-9
Table 5-3 Current and Projected Supplies, AFY	5-10
Table 6-1. Normal Year Supply and Demand Comparison, AFY	6-2
Table 6-2. Single Dry Year Supply and Demand Comparison, AFY	6-2
Table 6-3. Multiple Dry Year Supply and Demand Comparison, AFY	6-3

ACROYNMS & ABBREVIATIONS

AFY	Acre-feet per year
CA	California
CEQA	California Environmental Quality Act
CIMIS	California Irrigation Management Information System
CWC	California Water Code
DWR	Department of Water Resources
ETo	Evapotranspiration
GC	Groundwater Council
GIS	Geographic Information Systems
IRUWMP	Integrated Regional Urban Water Management Plan
MG	Million Gallons
MGD	Million Gallons per Day
MSL	Mean Sea Level
SAR	Santa Ana River
SB	Senate Bill
SBB	San Bernardino Basin
SWP	State Water Project
WFF	Water Filtration Facility
WFMP	Water Facilities Master Plan
WSA	Water Supply Assessment
WSC	Water Systems Consulting, Inc.
WVWD	West Valley Water District

WATER SUPPLY ASSESSMENT

1.0 Introduction and Purpose

This Water Supply Assessment (WSA) was prepared on behalf of Carson Companies for West Valley Water District (WVWD) by Water Systems Consulting, Inc. (WSC) to satisfy the requirements of California Water Code (CWC) Section 10910 (Senate Bill 610) for the Pepper 210 Commerce Center (Project). The Project lies within unincorporated area of the County of San Bernardino (County).

As required by Senate Bill 610 (SB 610), WVWD is responsible for assessing whether the total projected water supplies available during average, single dry, and multiple dry water years during a 20-year projection will meet the projected water demand for the Project, in addition to WVWD's existing and planned future uses. A water supplier's Urban Water Management Plan (UMWP) serves as a foundational document for a WSA. The water demands for the Project area were not explicitly included in the projections made in the Upper Santa Ana River Watershed 2020 Integrated Regional Urban Water Management Plan (2020 IRUWMP) (Water Systems Consulting, Inc. and Woodard & Curran, June 2021), as submitted to the California Department of Water Resources (DWR) in June 2021. Under this WSA, updated demands for this Project are provided and summarized in Section 4.0. Additional information from other sources is also incorporated into this WSA to document supplies from all sources, including groundwater and purchased water. Documentation includes identifying and quantifying water rights, contracts, and/or entitlements to the supply. WVWD must provide the results of the assessment to the County, as the Lead Agency, for inclusion in the California Environmental Quality Act (CEQA) document for the Project. This WSA includes the following:

- Overview of WVWD's water system (Section 2.0)
- Description of the Project and proposed water demand. Additional information on WVWD's current and projected water demands within the service area (Section 3.0 & 4.0)
- Information on WVWD's current and projected water supplies (Section 5.0)
- Discussion of WVWD's water service area water supply reliability and comparison of the water supplies and water demands for average, single dry, and multiple dry years (Section 6.0)
- Determination of WVWD's water service area water supply sufficiency (Section 7.0)

1.1 Legislation

WVWD has determined that the Project is subject to review under CEQA (*Public Resources Code, Section 21000 et seq.*), and the state CEQA Guidelines (*California Code of Regulations, Section 15000 et. seq.*) WVWD has determined that the Project is a "project" as defined in CWC 10912 and has determined that a WSA is required for the Project.

SB 610 amended the Public Resources Code, effective January 1, 2002, to incorporate CWC requirements for certain types of development projects to improve the link between information on water supply availability and certain land use decisions made by cities and counties. SB 610 seeks to promote more collaborative planning between local water suppliers, cities and counties by requiring detailed information regarding water availability to be provided to the city and county decision-makers prior to approval of specified large development projects.

Under SB 610, water suppliers must prepare WSAs for projects meeting certain project size criteria and deliver them to local governments for inclusion in any environmental documentation. The Project requires a WSA because it includes a proposed industrial, manufacturing, or

processing plant, or industrial park planned to house more than 1,000 persons, occupying more than 40 acres of land, or having more than 650,000 square feet of floor area. The Project exceeds the criteria for land coverage and building square footage.

1.2 Definitions

For the purposes of this WSA, the following defined terms are used:

- **Groundwater Production:** The amount of water produced from the Bunker Hill, Lytle, Rialto-Colton, Riverside North, and Chino Basins. These groundwater supply sources enter WVWD's distribution system based on metered flows at each well.
- **Surface Water:** The amount of water produced from Lytle Creek.
- **Purchased Water:** The amount of water imported from the State Water Project (SWP) through San Bernardino Valley Municipal Water District (Valley District) and put into the distribution system based on metered flows at the Lytle Turnout off the San Gabriel Feeder Pipeline.
- **Consumption:** The amount of billed metered water consumed by customers. The Project site includes one existing customer, Vulcan Materials.
- **Demand:** The amount of water distributed through the entire water system, which is the sum of groundwater production and purchased water. Demand includes non-revenue water, which is equal to the difference between water put into the distribution system and consumption.
- **Non-revenue water:** Unmetered water use and losses from the distribution system due to leaks, unauthorized connections, agency use (e.g., system flushing), theft, or other unmetered usage.
- **Water demand factor:** The calculated amount of water demand per unit (e.g., acre, sqft, dwelling unit, etc.) of a specific type of use (e.g., land use, development type, business type, etc.).

WATER SUPPLY ASSESSMENT

2.0 Public Water System Overview

WVWD is located in the southwest region of San Bernardino County, California, and serves the Cities of Rialto, Fontana, Colton, and Jurupa Valley, and unincorporated areas of San Bernardino County. Figure 2-1 shows WVWD's service area.

The Project is located entirely within WVWD's northern service area section. WVWD's total water service area encompasses approximately 31 square miles and is located approximately 50 miles east of Los Angeles. WVWD is bounded by the City of Fontana to the west, the City of San Bernardino to the east, the U.S. Forest Service boundary to the north, and the County of Riverside to the south.

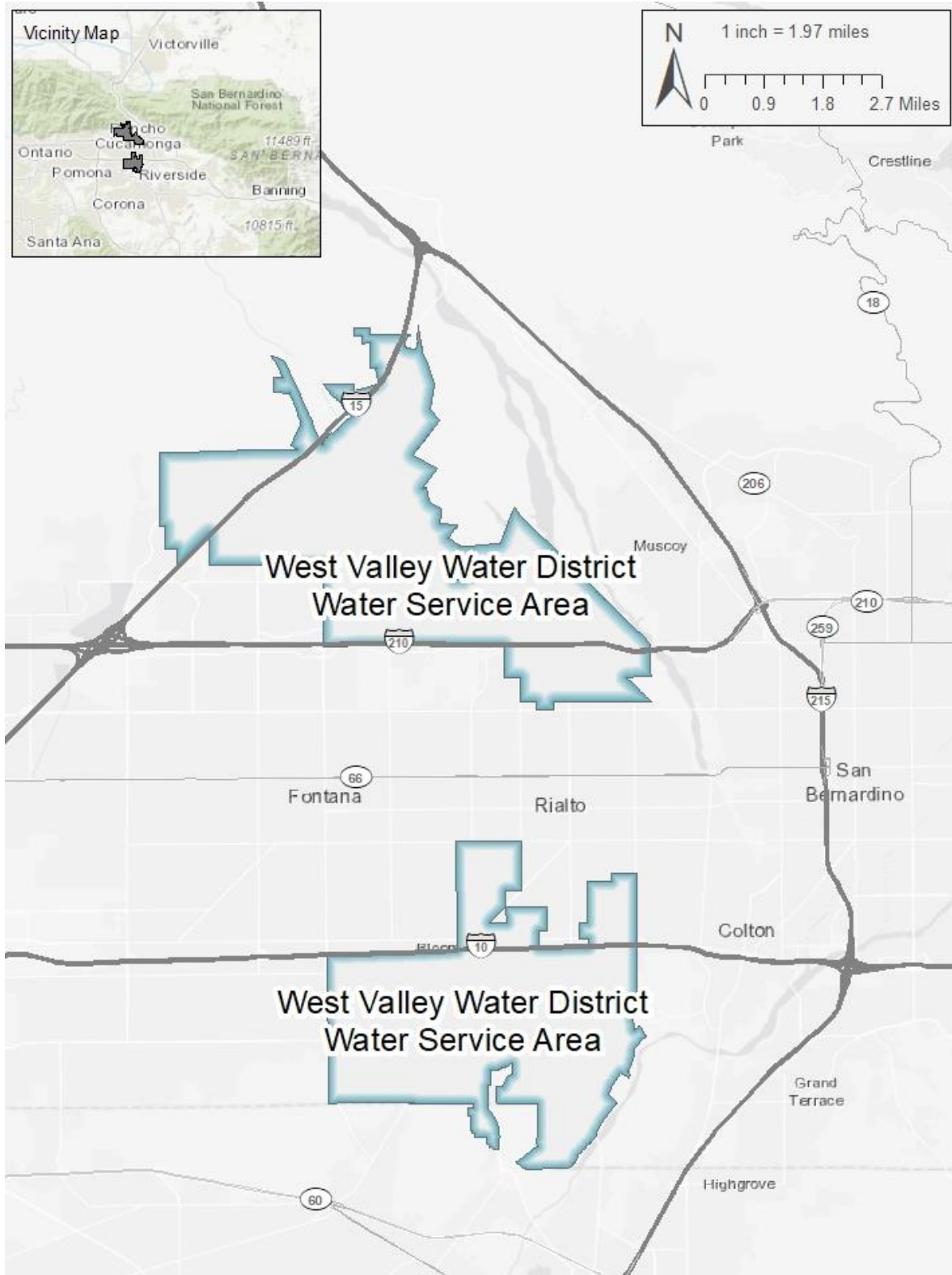

Figure 2-1. WVWD Service Area

2.1 Climate

WVWD's climate is characterized by hot, dry summers and cool winters with intermittent precipitation. Table 2-1 presents average climate data for the service area, including temperature, rainfall, and reference evapotranspiration (ET_o). As shown in Table 2-1, the warmest months of the year are July and August, with an average temperature of 80 degrees Fahrenheit (°F), while the coldest month of the year is December with an average temperature of 53.6°F.

The monthly average precipitation at WVWD is about 1.2 inches; annual average precipitation is estimated as 14.3 inches. As shown in Table 2-1, the majority of the rainfall occurs in the months of December through March. January and February are the wettest months with an average rainfall of approximately 2.3 inches.

Table 2-1. Historical Temperature, Rainfall and Reference Evapotranspiration (ET_o) Data

Month	Average Temperature (°F)	Average Precipitation (in.)	Average Standard ET _o (in.)
January	53.9	2.58	2.22
February	54.1	2.12	2.78
March	58.1	2.09	4.12
April	64.5	1.32	5.54
May	67.0	0.69	5.99
June	74.7	0.32	7.21
July	80.0	0.69	8.10
August	80.1	0.53	7.44
September	77.0	0.34	5.77
October	69.2	0.45	4.42
November	61.5	1.06	2.91
December	53.6	2.09	2.10

Note:

Data provided from the California Irrigation Management Information System (CIMIS) weather station 251 in Highland, CA; average values provided based on data from 2017 through 2021.

2.2 Service Area Population

The current and projected population for WVWD's water service area is shown in Table 2-2. The projected population was prepared as part of the 2020 IRUWMP. 2020 population was determined using the California Department of Water Resources (DWR) Geographic Information Systems (GIS)-based tool (DWR Tool) to estimate the population within WVWD's service area using census data and the number of service connections. Future population was projected based on the 2020 WVWD Water Facilities Master Plan (WFMP). Based on various growth

rates identified in the WFMP, it was estimated that population between 2020 and 2025 would grow at 2.84%, then reduce to an annual growth rate of 1.5% from 2025 through 2045 (AKEL Engineering Group, Inc., July 2020).

Table 2-2. Historical, Current and Projected Population

	2020	2025	2030	2035	2040	2045
WVWD Water Service Area Population	89,101	102,490	110,410	118,943	128,136	138,039

Note: Population projection developed in the 2020 IRUWMP (Water Systems Consulting, Inc. and Woodard & Curran, June 2021).

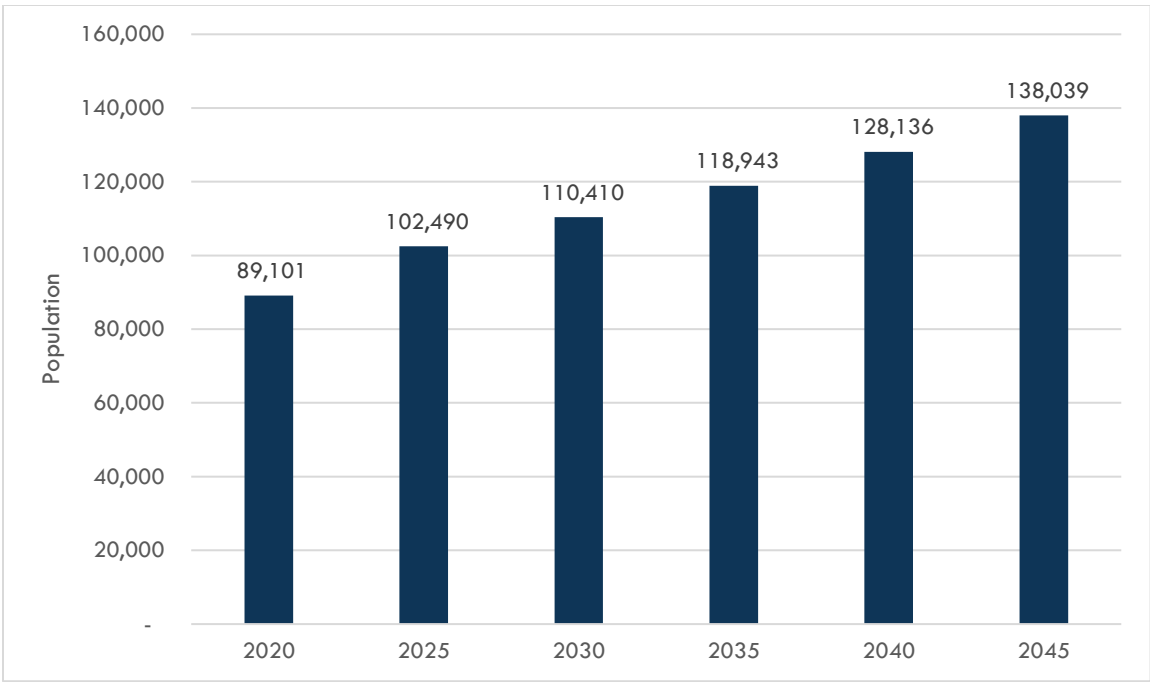

Figure 2-2. Historical, Current and Projected Population Trends

2.2.1 Other Demographic Factors

WVWD provides service to a variety of customers, including single family, multi-family, commercial, industrial, institutional, landscape irrigation, hydrant, golf course, fire service, and agricultural irrigation accounts. WVWD also provides wholesale water through an interconnection with Marygold Mutual Water Company. Based on information gathered in the 2020 IRUWMP, approximately 44 percent of households within WVWD are considered very-low and low-income households (Water Systems Consulting, Inc. and Woodard & Curran, June 2021).

WATER SUPPLY ASSESSMENT

3.0 Project Description

The Project will be constructed at 20080 North Highland Avenue within unincorporated San Bernardino County and will replace the existing Vulcan Materials aggregate processing plant, asphalt plant and concrete batch plant. The 101.3 acre Project site is located on the north side of the CA-210 freeway, west of the Cajon Wash, and east of N Oakdale Avenue. The proposed Project is comprised of two structures: a warehouse, distribution, and logistics building, totaling 1,255,354 square feet (sf) and a single-story office building totaling 2,100 sf.

The warehouse, distribution, and logistics building (1,255,354 sf) will include 25,000 sf of mezzanine office space. The warehouse will feature 42-ft minimum clear heights and may include additional mezzanine warehouse storage space, not currently included in the previously referenced square footage. The building features also include abundant car and tractor-trailer parking stalls. The single-story office building will include a lounge area and restrooms, totaling 2,100 sf. The proposed Project facilities are illustrated in Figure 3-1. The Project is anticipated to be completed by 2027.

The Project will require water for consumptive and sanitary purposes to support employees at the facility and for irrigation of landscaped areas. The Project site covers an area that is currently occupied by Vulcan Materials Company. Vulcan Materials Company has planned to cease operations, reclaim the site in accordance with their reclamation plan, and end its lease prior to redevelopment for this Project.

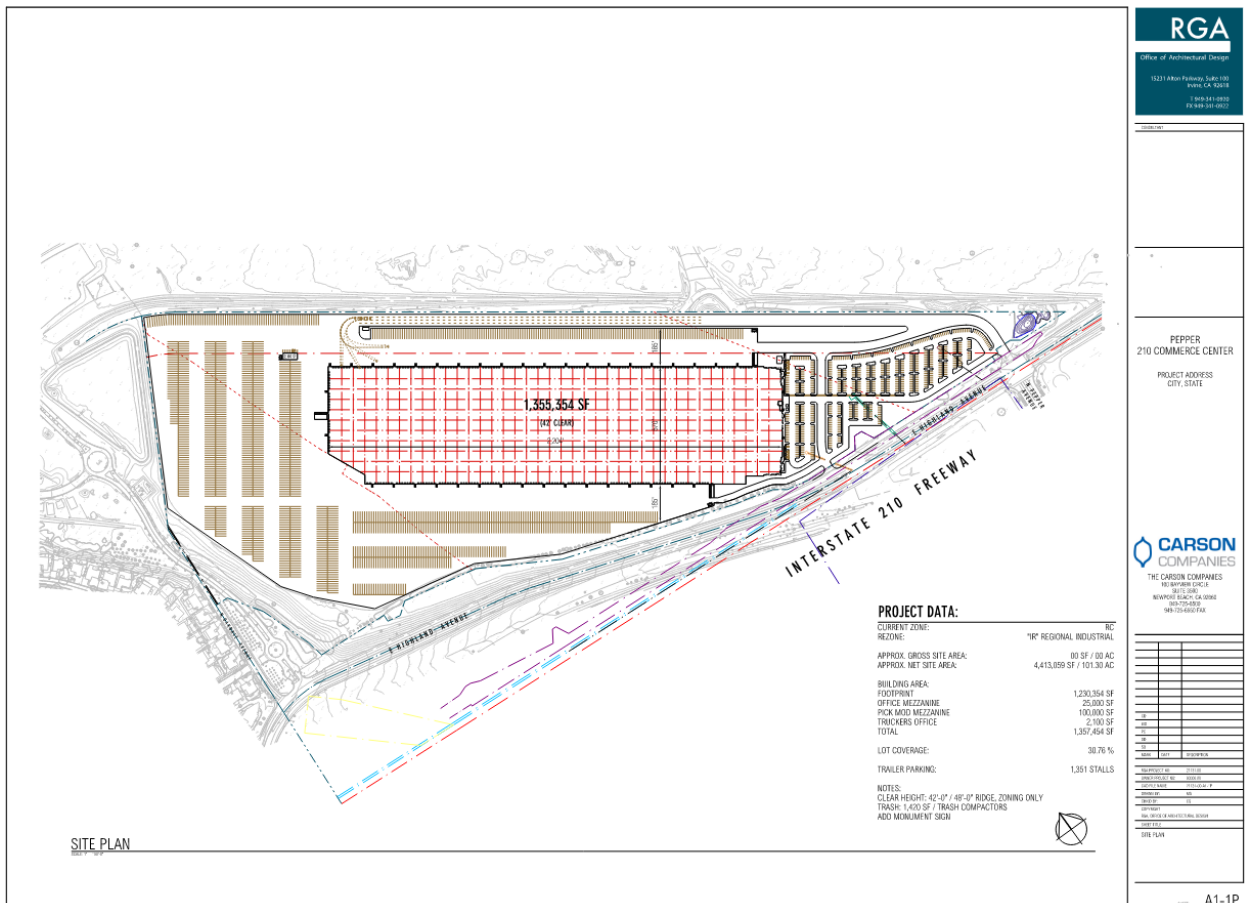

Figure 3-1. Project Site Plan

The Project site lies within pressure zone 4 of the northern section of WVWD’s water service area, a public water system as defined in CWC Section 10912. Figure 3-2 depicts the Project location with respect to WVWD’s service area boundaries.

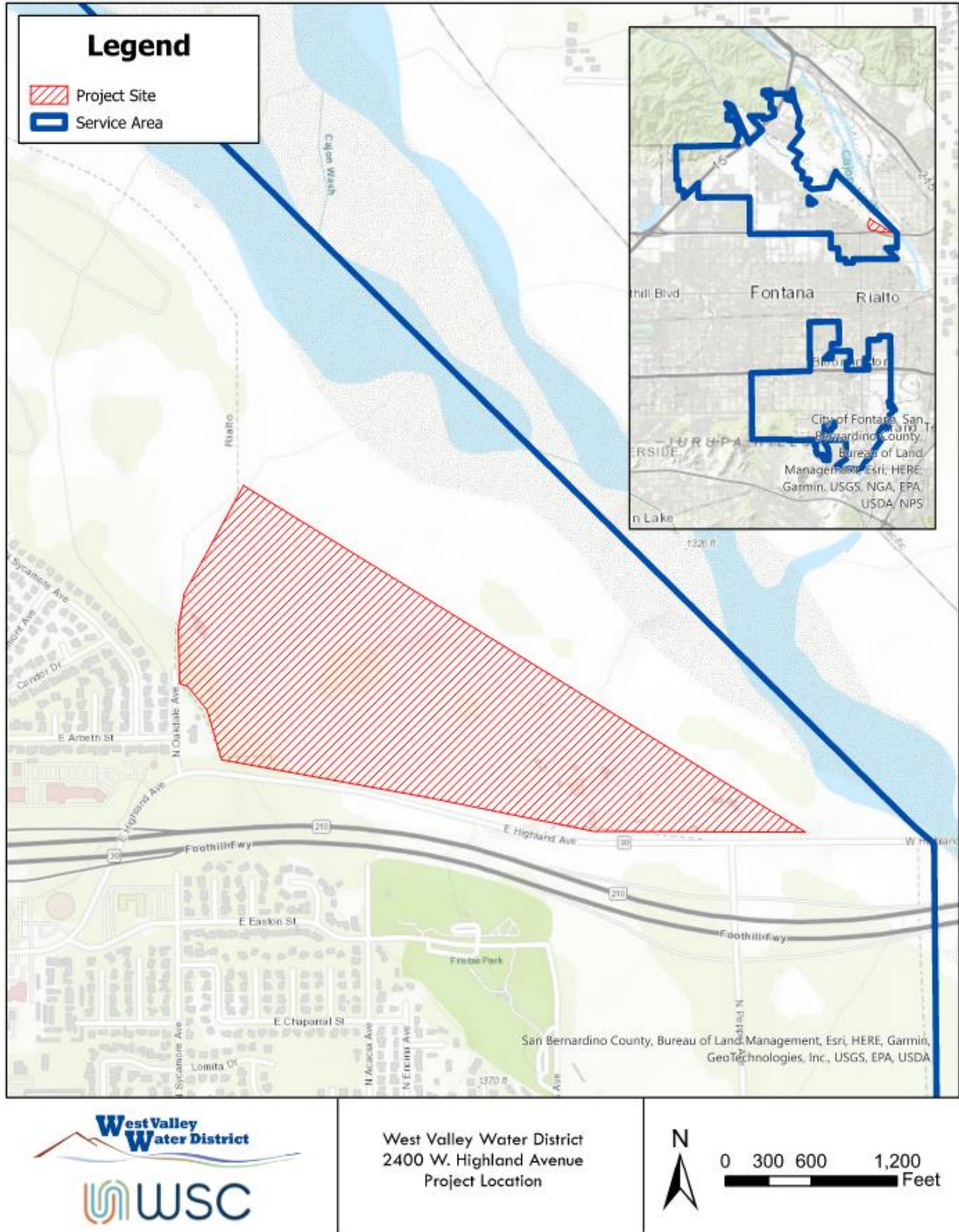

Figure 3-2. Project Location

WATER SUPPLY ASSESSMENT

4.0 Project Water Demand

The 2020 IRUWMP summarized existing demands and projected future demands based on estimated number of future water connections and associated demand factors. Future connections were based on projected population growth identified in the WFMP. To estimate Project demand, land use-based water demand factors from the 2020 WFMP were applied. The results of the demand analysis are discussed in this section.

4.1 Project Water Demand Projections

Water demand factors were applied to projected development units (acres) to estimate Project demands. These factors were selected from the 2020 WFMP and applied to the Project land use. The County designated the Project's land use zoning as Regional Industrial (IR), which corresponds to the 2020 WFMP's Heavy Industrial water demand factor category. The estimated water demand factor applied is provided in Table 4-1.

Based on the demand factors developed in the WFMP, the demand for this Project is estimated at 174 acre-feet per year (AFY), as shown in Table 4-1. Historical usage for the existing customer at the Project site was 55 AFY; therefore, the net additional Project demand is 119 AFY, as shown in Table 4-2 (Project demand less existing customer use). If the actual land use specified for this Project changes, the associated water demand may change and would need to be reevaluated.

Table 4-1. Project Demand, AFY

Use	Area (Acres)	WFMP Demand Factor (gpd/acre)	Demand, AFY
Warehouse	101.3	1,530	174

Note: Demand Factor provided in the 2020 WFMP Table 3-4 (AKEL Engineering Group, Inc., July 2020).

Table 4-2. Net Project Demand, AFY

	Demand, AFY
Existing Customer Use	55
Project Demand	174
Net Project Demand	119

Note: Existing customer use based on historical billing records for 2020.

The Project is anticipated to be completed as early as the end of 2027 but may not be completed until later pending negotiations with the existing customer on the Project site. For the purposes of this WSA, it is assumed the Project will be developed by 2030. For this reason, the Project demand was compared to the demands projected within the 2020 IRUWMP starting in 2030. The 2020 IRUWMP reports projections every five years (2025, 2030, 2035, 2040, and 2045).

The demand for this Project was compared to existing and future projected industrial demand summarized in the 2020 IRUWMP and summarized in Table 4-3 below. The IRUWMP projected a 142 AFY increase of industrial demands from 2020 to 2030, which is greater than the Project's net demand. However, the Project demand was not explicitly captured in the IRUWMP's demand projection methodology, primarily because the Project requires a land use zoning change. Net Project demand was added to the demands from the 2020 IRUWMP as shown in Table 4-3 below.

Table 4-3. 2020 IRUWMP Projected Demand for Industrial Customers with the Addition of Net Project Demand

Customer Class	Demand, AFY					
	2020	2025	2030	2035	2040	2045
Industrial	623	717	765	813	861	909
Additional Net Project Demand	-	-	119	119	119	119
Total Industrial Demand	623	717	884	932	980	1,028

Industrial demand for 2020 provided in Table 10-3 and industrial demand for 2025 – 2045 provided in Table 10-5 of the 2020 IRUWMP.

WATER SUPPLY ASSESSMENT

5.0 Water Supply Analysis

WVWD utilizes three primary sources for drinking water supply: local surface water, groundwater, and imported water from the State Water Project (SWP). Groundwater is the primary source of supply. This section describes each water source in more detail.

5.1 Water Sources

WVWD's distribution system is divided into eight pressure zones and utilizes 25 reservoirs for a total storage capacity of 72.6 million gallons (MG). WVWD also operates a 14.4 MGD water filtration facility. The following sections describe each water source in more detail. Additional details on each water supply source are provided in the 2020 IRUWMP.

5.1.1 Purchased or Imported Water

WVWD purchases SWP water from the San Bernardino Valley Municipal Water District (Valley District) through the Lytle Turnout off the San Gabriel Pipeline Feeder. Metering and transmission facilities are sized to enable WVWD to purchase and treat up to 20 million gallons per day (MGD), approximately 23,000 AFY, at final treatment plant expansion. SWP water is treated at WVWD's Oliver P. Roemer Water Filtration Facility (WFF) and used for potable supply. WVWD is investigating the use of SWP water for groundwater recharge in the Lytle Creek Basin. In 2006, the WFF was expanded to increase production capacity to 14.4 MGD. In 2020, WVWD began the design of a 7.2 MGD expansion of the WFF to increase capacity to 21.6 MGD. WVWD has utilized SWP water through the Lytle Turnout since 1999.

5.1.2 Groundwater

WVWD draws the majority of its supply from its wells from five regional groundwater basins: Bunker Hill and Lytle Creek (which are both part of the San Bernardino Basin or SBB), Rialto-Colton, Riverside North, and Chino Basins. All five basins have been adjudicated and are managed for long term sustainability. Details on adjudication and management are provided in the 2020 IRUWMP.

WVWD's historical groundwater production for 2016 through 2021 is shown in Table 5-1.

5.1.2.1 Bunker Hill and Lytle Creek (Part of SBB)

The San Bernardino Basin (SBB), labeled as the "San Bernardino Basin Area" in the Western-San Bernardino Judgment (Western Judgment), was defined by, and adjudicated in gross, by the Western Judgment in 1969. The SBB has a surface area of approximately 141 square miles and lies between the San Andreas and San Jacinto faults. The basin is bordered on the northwest by the San Gabriel Mountains and Cucamonga fault zone; on the northeast by the San Bernardino Mountains and San Andreas fault zone; on the east by the Banning fault and Crafton Hills; and on the south by a low, east-facing escarpment of the San Jacinto fault and the San Timoteo Badlands. Alluvial fans extend from the base of the mountains and hills that surround the valley and coalesce to form a broad, sloping alluvial plain in the central part of the valley. The SBB encompasses the Bunker Hill sub basin (DWR Number 8.02-06) defined by DWR and also includes a small portion of the Yucaipa Basin (8-02.07) and the Rialto-Colton Basin (8-02.04) as defined by DWR.

The Western Judgment established the natural safe yield of the SBB to be a total of 232,100 AFY for all extractions, including surface water diversions and groundwater pumping. The Western Judgment is provided in Appendix B. Surface water is diverted from Mill Creek, Lytle Creek, and the Santa Ana River (SAR).

The Western Judgment allocates 64,862 AFY of the safe yield, which equates to 27.95 percent, to the Plaintiffs. The Plaintiffs include the City of Riverside (the successor to the Riverside Water Company and the Gage Canal Company), Riverside Highland Water Company, Meeks & Daley Water Company, and Regents of the University of California. The Riverside County agencies may not exceed their allocation unless they participate in “New Conservation” (explained below).

The Non-Plaintiffs’ (agencies within San Bernardino County, including WVWD) rights were defined in the Judgment as 167,238 AFY, which equates to 72.05 percent of the safe yield. San Bernardino agencies are allowed to extract more than 167,238 AFY from the SBB, as long as they import and recharge a like amount of water into the SBB. The Western-San Bernardino Watermaster provides an annual accounting of both the plaintiff and non-plaintiff extractions and a comparison to the safe yield. The Western Judgment requires the non-plaintiffs to provide replenishment water whenever the cumulative extractions exceed the cumulative safe yield. If the cumulative extractions are less than the cumulative safe yield, a “credit” is earned. In years when cumulative extractions are greater than their allocation, a “debit” is taken. To date, the cumulative extractions have been less than the cumulative safe yield since the Western Judgment was signed so that the non-plaintiffs have never been required to recharge the basin.

Recharge is also required to offset the export of water outside the SBB in excess of the amount recorded during the base period (1959-1963). Credits are earned for any new supplies such as stormwater capture. As of the accounting performed for the 2020 Annual Western-San Bernardino Watermaster Report, the Non-Plaintiffs have 463,168 AF of net credit accumulated in the SBB and are, therefore, not required to recharge. Although there is no recharge requirement under the Western Judgment, the Non-Plaintiffs have continued to recharge the SBB.

WVWD, in a joint venture agreement with the City of Rialto, the Riverside Highland Water Company, and Valley District, constructed 25,000 feet of 48-inch transmission line known as the Baseline Feeder, which delivers Bunker Hill groundwater to WVWD. Through this agreement, WVWD can receive up to 5,000 AFY of supply through this transmission line from Valley District. WVWD has received water through the Baseline Feeder since 1998.

5.1.2.2 Lytle Creek Sub Basin

Lytle Creek Basin is part of the SBB, and it is not identified as a separate sub-basin in DWR Bulletin 118-2003; however, the sub basin is an integral part of the Upper Santa Ana Valley Groundwater Basin and a major recharge area for both the Bunker Hill and Rialto-Colton sub

basins. Historically, local agencies have recognized Lytle Creek sub basin as a distinct groundwater sub basin. In the Western Judgment, the Bunker Hill and Lytle Creek sub basins are combined into the SBB. However, the three separate water-bearing zones and intervening confining zones of the Bunker Hill sub basin are not observed in the Lytle Creek sub basin. Sediments within the Lytle Creek sub basin are, for the most part, highly permeable, and the aquifer has a high specific yield. High permeability and specific yield tend to result in an aquifer that responds rapidly to changes in inflow (precipitation and streamflow) and outflow (groundwater pumping, streamflow, and subsurface outflow).

Lytle Creek sub basin is adjoined on the west by the Rialto-Colton sub basin along the Lytle Creek fault, and on the east and southeast by the Bunker Hill sub basin along the Loma Linda fault and Barrier G. The northwestern border of the sub basin is delineated by the San Gabriel Mountains, and runoff from the mountains flows south/southeast through Lytle and Cajon Creeks into the basin.

Numerous groundwater barriers are present within Lytle Creek sub basin, resulting in six compartments within the sub basin. Barriers A through D divide the northwestern portion of the sub basin into five sub-areas and the southeastern portion of the sub basin comprises the sixth sub-area. Barrier F divides the northwestern sub-areas from the southeastern sub-area. Studies have shown that the groundwater barriers are less permeable with depth. When groundwater levels are high during wet years, more leakage occurs across the barriers than when groundwater levels are lower (i.e., during dry years). The amount of pumping in each sub-area, in large part, controls the movement of groundwater across the barrier within the older alluvium but not the younger alluvium.

It is important to note that the water rights in Lytle Creek are set forth in long-standing court judgments governing the rights of the parties in that basin. The Lytle Creek Basin was adjudicated under the 1924 Judgment No. 17,030 from the Superior Court of San Bernardino County (Lytle Creek Judgment) and is managed by the Lytle Creek Water Conservation Association, which is made up of the successors to the stipulated parties of the Lytle Creek Judgment.

5.1.2.3 Rialto-Colton Basin

The Rialto-Colton subbasin underlies a portion of the upper Santa Ana Valley in southwestern San Bernardino County and northwestern Riverside County. This subbasin is about 10 miles long and varies in width from about 3.5 miles in the northwestern part to about 1.5 miles in the southeastern part. This subbasin is bounded by the San Gabriel Mountains on the northwest, the San Jacinto fault on the northeast, the Badlands on the southeast, and the Rialto-Colton fault on the southwest. The Santa Ana River cuts across the southeastern part of the basin. The basin generally drains to the southeast, toward the Santa Ana River. Warm and Lytle

Creeks join near the southeastern boundary of the basin and flow to meet the Santa Ana River near the center of the southeastern part of the sub basin.

The groundwater extractions in the Rialto-Colton sub basin are governed by the Rialto Basin Decree, the Rialto Basin Settlement Agreement, and the Western Judgment. The Rialto-Colton Subbasin was adjudicated under the 1961 Decree No. 81,264 from the Superior Court of San Bernardino County (Rialto Basin Decree).

In any year in which the average of the elevation of the spring-high water level, measured in March, April, and May, in the three index wells is above 1002.3 feet mean sea level (msl), WVWD has no restrictions on yearly extractions. When the average standing water levels in the three index wells falls below 1002.3 feet msl and is above 969.7 feet msl, WVWD is restricted to total groundwater extractions of 6,104 AFY. When the average of the three index wells drops below 969.7 feet msl, ground water extractions are reduced for all parties stipulated in the decree by 1 percent per foot below the 969.7-foot level, but not to exceed 50-percent reduction. WVWD's total water right allocation of 6,104 AFY includes 510 AFY of fixed rights and 5,594 AFY that is adjustable and subject to the groundwater reductions specified in this section.

WVWD participates in the Rialto Basin Groundwater Council (Rialto Basin GC), which was formed in 2021. The Rialto Basin GC will develop, adopt, and implement a sustainable groundwater management plan, which will include implementing groundwater recharge projects to restore groundwater levels.

5.1.2.4 North Riverside Basin

The North Riverside Basin (the portion of the Riverside Basin Area in San Bernardino County) is part of the 1969 Judgment No. 117,628 (see Appendix B), under the Bunker Hill Basin. The Riverside Groundwater Basin is a large alluvial fill basin that is bounded by major faults and topographic barriers. Recharge to the basin occurs by the underflow from basins to the north, contributions from the Santa Ana River, and from percolation of surface water runoff from the surrounding uplands, in particular the Box Spring Mountains to the east. WVWD, which has no limits or restrictions on groundwater pumping in the basin, has been utilizing the North Riverside Basin for water supply for more than 60 years.

Extractions from the North Riverside Basin for use in Riverside County are limited to 21,085 AFY by the Judgment. Extractions for use in San Bernardino County are unlimited, provided that water levels at three index wells in the Rialto-Colton and Riverside North Basins stay above 822.04 feet MSL. The 2015 IRWMP provided an estimate of 30,100 AFY as the sustainable supply from North Riverside for use in San Bernardino County, based on extractions from 1996 to 2005. Valley District has budgeted to update the safe yield estimate prior to the next IRUWMP.

5.1.2.5 Chino Basin

The Chino Basin is an adjudicated basin managed by the Chino Basin Watermaster. The Chino Sub basin lies in the southwest corner of San Bernardino County. The Chino Sub basin is

bordered to the east by the Rialto-Colton fault. In the other three directions, the Chino Sub basin is ringed by impermeable mountain rock, the San Gabriel Mountains to the north, the Jurupa Mountains and Puente Hills to the south and southwest. Average annual precipitation across the basin is 17 inches. This part of the San Bernardino Valley is drained by San Antonio Creek and Cucamonga Creek southerly to the Santa Ana River.

On January 2, 1975, several Chino Basin producers filed suit in California State Superior Court for San Bernardino County (the "Court") to settle the problem of allocating water rights in the Chino Basin. On January 27, 1978, the Court entered a judgment in Chino Basin Municipal Water District v. City of Chino et al. (Chino Basin Watermaster Judgment, provided in Appendix D) adjudicating water rights in the Chino Basin and establishing the Chino Basin Watermaster. This Judgment adjudicated all groundwater rights in Chino Basin and contains a physical solution to meet the requirements of water users having rights in or dependent upon the Chino Basin. The Judgment also appointed the Watermaster to account for and implement the management of the Chino Basin. The Judgment declared that the initial operating safe yield of the Chino Basin is 145,000 AFY. The Basin is managed through implementation of the Chino Optimum Basin Management Plan. Per the Judgment, WVWD owns rights to approximately 900 AFY of extraction rights. Extractions above that amount must be replenished with SWP water through a program with the Chino Basin Watermaster.

Due to water quality constraints, WVWD does not currently use their rights within the Chino Basin. WVWD is looking at options to utilize these rights, including nitrate treatment and delivery through interties with other agencies. By 2030, WVWD may use this supply directly.

Table 5-1. Historical Groundwater Production, AFY

Groundwater Basin	2016	2017	2018	2019	2020	2021
Bunker Hill	5,452	5,640	5,777	4,508	5,549	4,447
Lytle Creek	1,850	2,365	2,416	2,572	3,078	3,763
Chino	-	-	-	-	-	-
Rialto-Colton	2,123	3,923	3,353	2,779	1,420	4,041
Riverside-Arlington	2,745	1,089	1,542	1,301	1,354	1,152
Total	12,170	13,017	13,088	11,160	11,401	13,403

5.1.3 Surface Water

WVWD utilizes local surface water from the east side of the San Gabriel Mountains, including North Fork Lytle Creek, Middle Fork Lytle Creek, and South Fork Lytle Creek. WVWD has the right to divert and export out of the Lytle Creek Region 2,290 gpm when it is available. WVWD can also purchase an additional 1,350 gpm of Lytle Creek flows through an agreement with the City of San Bernardino (San Bernardino is not able to utilize their surface water flows), which is treated at the Oliver P. Roemer WFF. WVWD also utilizes Lytle Creek surface water flows for groundwater recharge in the Lytle Creek Basin.

When the flows at the mouth of Lytle Creek Canyon drop below 7,182 gpm (798 miners inches), all diversion rights holders must reduce their diversions to a prorated schedule set in the 1897 decree. If WVWD is not receiving its full Lytle Creek surface water allotment, they are permitted to make up the difference by additional pumping in the Lytle Creek Region.

5.2 Transfer Opportunities

WVWD currently has interconnections with the Fontana Water Company, Marygold Mutual Water Company, Valley District, and the Cities of Rialto, Colton and San Bernardino which can be utilized as needed for short-term supply needs. These connections are not typically used for extended periods.

5.3 Future Water Projects

To meet future demands within the system, WVWD plans to rehabilitate existing wells, to drill new wells, and equip wells with wellhead treatment if required. These wells are planned for various groundwater basins and pressure zones within the distribution system.

WVWD is expanding the Oliver P. Roemer Water Filtration Facility by 7.2 MGD for a total capacity of 21.6 MGD to allow additional treatment of SWP water, when available.

When planning future water supply sources, WVWD selects projects that will provide sufficient supply to meet peak day demands. When possible, these sources are planned by pressure zone, thereby reducing the need to lift water to a higher zone.

As development progresses and increases demands are placed on the system, WVWD will determine which projects to implement. Although WVWD may not need to utilize each source to its full potential, construction of these water supply projects gives WVWD this option should one or more sources be off-line due to maintenance.

As part of the Rialto Basin GC, WVWD plans to collaborate with the other parties to implement groundwater recharge in the Rialto Basin to increase water levels. Increased water levels will result in an increase in WVWD's allowable pumping from the Rialto Basin, thereby increasing

supply. The Rialto Basin GC will be developing a groundwater management plan that will identify recharge goals and projects and the potential supply increase is not yet quantified.

5.4 Recycled Water

The wastewater collected within different portions of WVWD's service area is treated by the City of Rialto, the City of Colton, San Bernardino County, or the Inland Empire Utilities Agency. In 2012, WVWD prepared a master plan to evaluate potential uses of recycled water within its service area. WVWD does not currently have a recycled water distribution system and is not pursuing recycled water use at this time because it is not cost effective to extend facilities from the wastewater treatment plants to the locations of potential use.

5.5 Water Supply Summary

WVWD's historical water supplies are summarized in Table 5-2.

Table 5-2. Water Supplies – Historical, AFY

Water Supply	Additional Detail on Water Supply	2015	2016	2017	2018	2019	2020	2021
Groundwater	Lytle Creek	2,159	1,850	2,365	2,416	2,572	3,078	3,763
	Riverside North	2,065	2,745	1,089	1,542	1,301	1,354	1,152
	Rialto- Colton	2,505	2,123	3,923	3,353	2,779	1,420	4,041
	Bunker Hill	1,520	1,351	2,300	2,002	891	1,933	1,650
	Chino	0	0	0	0	0	0	0
Purchased or Imported Water	SWP Water	2,244	2,839	2,653	4,042	3,649	3,342	4,979
	Baseline Feeder	4,367	3,380	3,151	3,701	3,512	3,616	2,797
Surface Water	Lytle Creek	2,271	2,026	4,540	3,748	4,023	5,356	3,442
Total		17,131	16,314	20,021	20,804	18,727	20,098	21,824

WVWD plans to utilize a greater amount from each of its supply sources, up to the legal rights and availability. WVWD's available supplies for future years are summarized in Table 5-3. These quantities are established in the 2020 IRUWMP.

Table 5-3 Current and Projected Supplies, AFY

Water Supply	Additional Detail on Water Supply	2025	2030	2035	2040	2045
Groundwater	Bunker Hill (part of SBB)	2,052	2,353	3,554	4,754	6,455
	Bunker Hill (part of SBB, via Baseline Feeder)	5,000	5,000	5,000	5,000	5,000
	Lytle Creek (part of SBB)	2,900	2,900	2,900	2,900	2,900
	Rialto-Colton	4,426	4,538	4,650	4,761	4,873
	Riverside-Arlington	2,500	3,000	3,500	4,000	4,000
	Chino	-	900	900	900	900
Purchased or Imported Water	SWP – Rialto Colton Groundwater Supplemental Supply	-	-	-	-	-
	SWP - Direct Delivery	7,000	7,000	7,000	7,000	7,000
Surface Water	Lytle Creek	3,100	3,100	3,100	3,100	3,100
Total		26,978	28,791	30,603	32,415	34,229

5.6 Water Supply Reliability

WVWD performed a water service reliability assessment as part of the 2020 IRUWMP and assumed that demands could increase as much as 10% in single and consecutive dry year conditions. Although water use may decrease in later years of a multiple year drought, the reliability assessment assumed a 10% increase to be conservative.

Valley District has been conducting groundwater recharge activities in the SBB since 1972 and participates in conjunctive use programs to store water in local groundwater basins during wet years for use in dry years. It is estimated that Valley District and its agencies will benefit by increasing water levels, reducing pumping costs, and obtaining up to 88,500 AF of storage and up to 29,500 AF of dry year yield. There are various planned groundwater recharge projects outlined in the 2020 IRUWMP to help increase supply resiliency.

The effects of a local drought are not immediately recognized since the region uses the local groundwater basins to simulate a large reservoir for long term storage. While pumping rights from the Rialto Basin and available surface water may be reduced in dry years, WVWD is able to pump additional groundwater from Bunker Hill, Lytle, and Riverside North to meet total demands in dry years and participates in efforts to replenish the basins with imported and local water through regional recharge programs. WVWD's total groundwater supplies are not reduced in dry years, so 2020 was considered the base year in the reliability analysis. Based on the analysis, WVWD does not anticipate any shortage due to single or consecutive dry years, but participates in ongoing water conservation measures and regional recharge projects to optimize and enhance the use and reliability of regional resources. WVWD also has a water shortage contingency plan to put into action as appropriate to reduce the demand during critical drought years or other supply emergencies. WVWD's water shortage contingency plan is available in Part 4 of the 2020 IRUWMP and accessible at <https://www.sbvmd.com/reports/-/folder-1120>. The WSCP may be updated and adopted by WVWD staff as needed.

WATER SUPPLY ASSESSMENT

6.0 Water Supply and Demand Analysis

There has been a historical trend associated with drier years and an increase in water use among agencies. Conservation efforts have proven to be effective in decreasing water use in dry years, such as the historical drought of 2013-2015.

As noted in the previous section, WVWD has estimated that demands could increase by 10 percent during a single dry year in the reliability analysis conducted in the 2020 IRUWMP. During a multiple dry year period, it was assumed that demand could continue to exhibit the 10% increase as the most conservative estimate. It is expected that conservation messaging and restrictions would help reduce overall consumption.

Including 2020 IRUWMP and Project Net demands, Table 6-1 presents a comparison of supply and demand projections in a normal year, Table 6-2 presents a comparison of supply and demand projections in a single dry year, and Table 6-3 presents a comparison of supply and demand projections for multiple dry years. Demands shown here differ from the demands provided in the 2020 IRUWMP because they include the net increase in industrial demand required to serve the Project (119 AFY).

Table 6-1. Normal Year Supply and Demand Comparison, AFY

Totals	2025	2030	2035	2040	2045
Supply Totals	26,978	28,791	30,603	32,415	34,229
Demand Totals	23,459	25,154	26,730	28,307	29,883
Difference	3,519	3,637	3,873	4,108	4,346

Notes: Supply information provided in the 2020 IRUWMP Table 10-12. Demand totals updated to reflect addition of net Project demand.

Table 6-2. Single Dry Year Supply and Demand Comparison, AFY

Totals	2025	2030	2035	2040	2045
Supply Totals	29,676	31,670	33,663	35,657	37,651
Demand Totals	25,805	27,658	29,392	31,125	32,859
Difference	3,871	4,012	4,271	4,532	4,792

Notes: Supply information provided in the 2020 IRUWMP Table 10-14. Demand totals updated to reflect addition of net Project demand.

Table 6-3. Multiple Dry Year Supply and Demand Comparison, AFY

Year	Totals	2025	2030	2035	2040	2045
First Year	Supply Totals	29,676	31,670	33,663	35,657	37,651
	Demand Totals	25,805	27,658	29,392	31,125	32,859
	Difference	3,871	4,012	4,271	4,532	4,792
Second Year	Supply Totals	29,676	31,670	33,663	35,657	37,651
	Demand Totals	25,805	27,658	29,392	31,125	32,859
	Difference	3,871	4,012	4,271	4,532	4,792
Third Year	Supply Totals	29,676	31,670	33,663	35,657	37,651
	Demand Totals	25,805	27,658	29,392	31,125	32,859
	Difference	3,871	4,012	4,271	4,532	4,792
Fourth Year	Supply Totals	29,676	31,670	33,663	35,657	37,651
	Demand Totals	25,805	27,658	29,392	31,125	32,859
	Difference	3,871	4,012	4,271	4,532	4,792
Fifth Year	Supply Totals	29,676	31,670	33,663	35,657	37,651
	Demand Totals	25,805	27,658	29,392	31,125	32,859
	Difference	3,871	4,012	4,271	4,532	4,792

Year	Totals	2025	2030	2035	2040	2045
-------------	---------------	-------------	-------------	-------------	-------------	-------------

Notes: Supply information provided in the 2020 IRUWMP Table 10-15. Demand totals updated to reflect addition of net Project demand.

WATER SUPPLY ASSESSMENT

7.0 Determination of Water Supply Sufficiency

According to the 2020 IRUWMP, WVWD has adequate supplies to meet their customer demands and replacement water needs during average, single dry, and multiple dry years throughout the planning period. Even with the addition of Net Project demand to the projected demands established in the 2020 IRUWMP, WVWD anticipates sufficient supply to serve the Project with additional surplus supply for as-needed use. It is concluded that WVWD has adequate supplies to meet demands during average, single dry, and multiple dry years throughout the planning period. Should this Project be completed prior to its planned year (2027), the conclusions of this WSA are not expected to change.

WVWD is committed to minimizing the need to import water from other regions. WVWD will continue aggressive water conservation efforts to implement various Demand Management Measures, helping to reduce the need for imported water.

7.1 Conditions of Approval

This assessment of reliable water supply is conditioned on the following items:

ITEM 1: The property owner will install water efficient devices and landscaping according to the California Green Building Code (CalGreen) as enforced by San Bernardino County and applicable requirements of the WVWD's water use efficiency ordinance(s), local, and state ordinances, if any, at the time of building permit issuance to reduce this Project's demand on WVWD water supplies.

ITEM 2(a): The Developer will be required to apply for and submit a plan check for the installation of all new water services associated with the development of this Project.

ITEM 2(b): The Project will be required to connect to the 16" CMLC Zone 4 water line located in Highland Ave for all domestic, irrigation and fire services.

ITEM 2(c): All water improvements proposed for installation must be installed by one of the District's preapproved contractors. All development fees and deposits must be paid prior to construction of any water facilities.

ITEM 2(d): The Developer shall adhere to the most recent District's "Standards for Domestic Water Facilities" and "Water Service Rules and Regulations" and any amendments.

ITEM 3: This WSA will be reviewed every three (3) years from the WVWD Board approval date shown on cover of this WSA until the Project begins construction. The property owner shall notify the WVWD when construction has begun. The review will ensure that the information included in this WSA remains accurate and no substantial changes to the Project or WVWD's water supply have occurred. If the property owner has not contacted WVWD within three (3) years of the WVWD Board approval date shown on the cover of this WSA, it will be assumed that the proposed Project no longer requires the estimated water demand calculated, the demand for this Project will not be considered in assessments for future projects, and the assessment provided by this document will become invalid.

ITEM 4(a): Based on present information, WVWD has determined that it will be able to provide adequate water supplies to meet the potable water demand for this Project in addition to existing and future uses. WVWD reserves the right to revisit this WSA in the event that the Project's actual water demand is greater than the Project's estimated demand reported in this WSA or if a substantial change in the scope of the Project occurs.

ITEM 4(b): This WSA is not a commitment to serve the Project, but a review of WVWD's supplies based on present information available.

REFERENCES

AKEL Engineering Group, Inc. (July 2020). *2020 Water Facilities Master Plan*. Rialto: West Valley Water District.

Water Systems Consulting, Inc. and Woodard & Curran. (June 2021). *Upper Santa Ana River Watershed 2020 Integrated Regional Urban Water Management Plan*.

A

Appendix A Lytle Creek Judgment & Surface Water Purchase Agreement

B

Appendix B Western Judgment

C

Appendix C Rialto Basin Decree

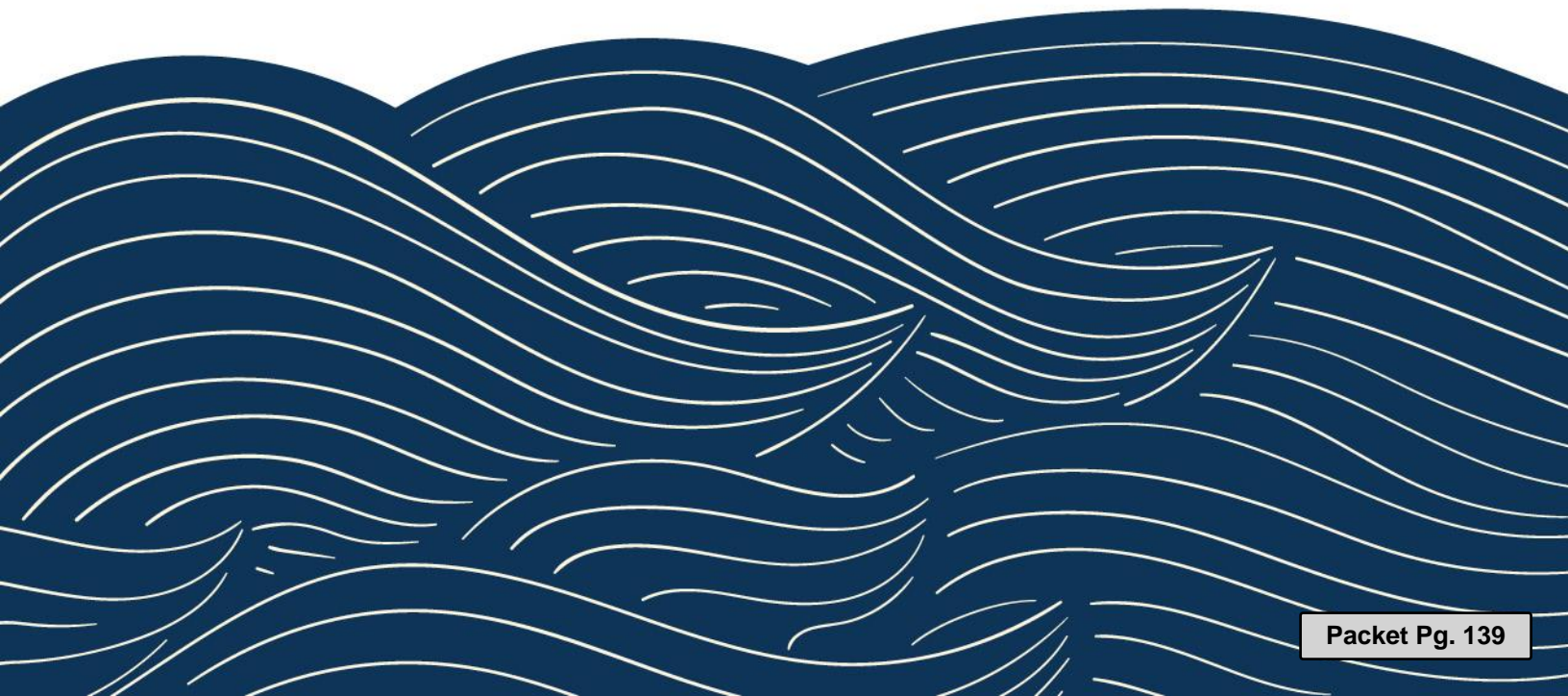

D

Appendix D Chino Basin Watermaster Judgment

E

Appendix E Baseline Feeder Agreement



**BOARD OF DIRECTORS
STAFF REPORT**

DATE: October 20, 2022
TO: Board of Directors
FROM: Van Jew, Acting General Manager
SUBJECT: GRANT OF EASEMENT FOR THE OLIVER P. ROEMER UPGRADE
AND EXPANSION PROJECT

BACKGROUND:

The West Valley Water District (“District”) Oliver P. Roemer Water Filtration Facility (“Roemer”) Upgrade and Expansion project will need to construct a 30-inch water main from the facility to the Zone 5 Reservoir. A private property located at 3450 N. Riverside Avenue, in the City of Rialto is between Via Bello Drive and the Zone 5 Reservoir as shown on the attached **Exhibit A**. The District is requesting to record an easement for the new 30-inch water main.

DISCUSSION:

On April 1, 2021, an Appraisal Report was prepared to determine the fair market value of the easement and estimated compensation for the proposed acquisition in the amount of \$4,300.00.

The private property owner (“Owner”) will provide a Grant of Easement to the District for the proposed 30-inch water main to supply water from the Roemer facility to the Zone 5 Reservoir for the price of \$4,300.00. Attached as **Exhibit B** is the Easement Agreement, showing the full extent of the easement and legal description.

FISCAL IMPACT:

The cost of the Grant of Easement is \$4,300.00. This item is included in the Fiscal Year 2022/23 Capital Improvement Budget under the W19041 Roemer Expansion Project and sufficient funds are available to cover the cost.

STAFF RECOMMENDATION:

Staff recommends that the Board of Directors to authorize entering into the Easement Agreement with the Owner for the cost of the Grant of Easement of \$4,300 and authorize the Acting General Manager to execute all necessary documents.

Respectfully Submitted,

Van Jew

Van Jew, Acting General Manager

BP:ls

ATTACHMENT(S):

1. Exhibit A - Private Property
2. Exhibit B - Easement Agreement

MEETING HISTORY:

10/12/22 Engineering, Operations and Planning Committee REFERRED TO BOARD

EXHIBIT A



Subject Property



Neighborhood

EXHIBIT B

BOARD OF DIRECTORS

Channing Hawkins
President – Division 4

Greg Young
Vice President – Division 5

Angela Garcia
Director – Division 1

Dan Jenkins
Director -Division 2

Kelvin Moore
Director – Division 3



ESTABLISHED AS A PUBLIC AGENCY IN 1952

WEST VALLEY WATER DISTRICT'S MISSION IS TO PROVIDE
OUR CUSTOMERS WITH SAFE, HIGH QUALITY AND RELIABLE
WATER SERVICE AT A REASONABLE RATE AND IN A
SUSTAINABLE MANNER.

ADMINISTRATIVE STAFF

Van M. Jew
Acting General Manager

September 27, 2022

Ms. Rosario Quevedo
3450 N. Riverside Ave.
Rialto, CA 92377

RE: 3450 N. Riverside Grant of Easement

Dear Ms. Quevedo,

This Easement Agreement (“Agreement”) is entered into and effective as of **September 27, 2022**, by and between West Valley Water District (“Grantee”) and Rosario Quevedo (“Grantor”) who agree as follows:

1. Grantor is the owner of a real property located at 3450 N. Riverside Drive, Rialto in the County of San Bernardino, State of California, as described on Exhibit A of the attached Grant of Easement (“Easement”).
2. Grantor agrees to sell Easement and grant to Grantee and Grantee agrees to purchase from Grantor a perpetual non-exclusive easement as described on the attached Easement showing the full extent of the easement and legal description.
3. The purchase price for the Easement is for the amount of **Four Thousand Three Hundred Dollars and 00/100 (\$4,300.00)**. Payment shall occur on or before thirty (30) days following recording of the Easement.

IN WITNESS WHEREOF, the parties hereto execute this Agreement.

**GRANTEE:
WEST VALLEY WATER DISTRICT**

By: _____
Van Jew, Acting General Manager

Date: _____

GRANTOR:

By: _____
Rosario Quevedo

Date: _____

**RECORDING REQUESTED BY AND
WHEN RECORDED RETURN TO:**

WEST VALLEY WATER DISTRICT
P.O. BOX 920
RIALTO, CA 92377-0920

ATTENTION: GENERAL MANAGER

THIS DOCUMENT MUST BE SIGNED
IN THE PRESENCE OF NOTARY &
NOTARIZED

No Recording Fee required Pursuant to Government Code Section 27383

APN: 0239-182-60

GRANT OF EASEMENT

FOR VALUABLE CONSIDERATION, receipt of which is hereby acknowledged Rosario Quevedo (“GRANTOR”) does hereby grant to **WEST VALLEY WATER DISTRICT**, a county water district, its successors and assigns (“GRANTEE”) a perpetual non-exclusive easement and right of way to construct, enlarge, reconstruct, remove and replace, operate, inspect, maintain, repair, improve and relocate for pipelines for the transmission of water, connections, devises and appurtenances in, on, over, under, upon, along, through and across the property hereinafter described, together with reasonable right of access to and from said easement for purposes of exercising the rights granted in said easement.

Said easement shall be in, under, over, and across that certain property situated in the County of San Bernardino, State of California, described as follows:

(SEE EXHIBITS “A” & “B” ATTACHED HERETO AND MADE A PART HEREOF)

The foregoing easement shall include:

- (a) The temporary use of such adjacent land of Grantor as is necessary to install the facilities provided for under the term of the easement granted herein; and
- (b) The right to enter upon and pass and repass over and along said strip or strips of land, and to deposit tools, implements and other materials thereon by Grantee, its officers, agents and employees, and by persons under contract to construct said pipeline or pipelines, and their employees, whenever necessary for the purpose of exercising the rights herein granted.

Grantor retains the right to the use of the land described herein except as to any use in derogation of the easement contained herein, and specifically agrees that no trees shall be planted thereon and, no buildings or other structures of any kind will be placed, constructed, or maintained over the real property described herein. Any work by Grantor, or any one working through or under Grantor, affecting the surface or subsurface of the ground subject to this easement shall be performed only after giving written notice by certified mail, postage paid, addressed to Grantee as its business office setting forth the proposed changes in detail. Such notice is to be given to the Grantee at least thirty (30) business days prior to commencement of such work and is subject to approval by Grantee. Notwithstanding the foregoing, the surface of the ground with respect to the distance from the ground surface to the top of any pipes, as of the date of this easement, shall not be changed by any party other than Grantee, if it results in:

- (a) “Cutting or removing the soil which leave less than thirty (30) inches of soil over the top of any pipe; and

(b) **“Hauling”** in of soil or “filling” which will leave more than ten (10) feet of soil over the top of any pipe.

It is understood that the permanent easements and the rights of way above described shall be acquired subject to the rights of the Grantor, Grantor’s successors, heir and assigns, to use the surface of the real property within the boundaries of such easements and rights of way. It is understood that any use of the surface rights by Grantor, and Grantor’s successors, heirs and assigns, shall be deemed a continuing permissive use allowed by Grantee, its successors, heirs and assigns, and each successor-in-interest of the Grantor, by acceptance of a conveyance of said property or interest therein admits and agrees that any such use is a continuing permissive use. It is understood that each and every right and privilege hereby granted is free and alienable.

Notwithstanding the foregoing, it is understood and agreed that this Grant of Easement shall not be construed as a Grant of fee title.

Grantee, its successors and assigns, shall restore, or cause to be restored, the surface or subsurface of the real property hereinabove described to the condition said property was in as of the time of performance of any enlargement, construction, reconstruction, removal and replacement, operation, inspection, maintenance, repair, improvement and relocation, and such restoration shall be performed with due diligence and dispatch.

IN WITNESS THEREOF, this instrument has been executed the _____ day of _____, 2022.

GRANTOR(S): _____ Rosario Quevedo _____

BY: _____

NAME: _____

ALL CAPACITY ACKNOWLEDGEMENT

A notary public or other officer completing this certificate verifies only the identity of the individual who signed the document to which this certificate is attached, and not the truthfulness, accuracy, or validity of that document.

STATE OF CALIFORNIA
COUNTY OF _____

On _____, before me, _____,
(Name and title of the officer)

personally appeared _____ who proved to me on the basis of satisfactory evidence to be the person(s) whose name(s) is/are subscribed to the within instrument and acknowledged to me that he/she/they executed the same in his/her/their authorized capacity (ies), and that by his/her/their signature(s) on the instrument the person(s), or the entity upon behalf of which the person(s) acted, executed the instrument.

I certify under **PENALTY OF PERJURY** under the laws of the State of California that the foregoing paragraph is true and correct.

WITNESS my hand and official seal.

Signature _____

(SEAL)

EXHIBIT "A"

BEING A PORTION OF PARCELS 1 AND 3 OF THAT CERTAIN PARCEL OF LAND DESCRIBED IN DEED RECORDED MAY 28, 1993 AS INSTRUMENT No. 93-242037, OF OFFICIAL RECORDS OF SAN BERNARDINO COUNTY, CALIFORNIA, MORE PARTICULARLY DESCRIBED AS FOLLOWS:

PARCEL "A" PERMANENT EASEMENT

A 20 FEET WIDE STRIP OF LAND MEASURING 10 FEET EACH SIDE OF THE FOLLOWING DESCRIBED LINE:

BEGINNING AT THE CENTERLINE INTERSECTION OF VIA BELLO DRIVE AS SHOWN ON PARCEL MAP 16376, RECORDED IN BOOK 206, PAGES 56 AND 57, OFFICIAL RECORDS OF SAID COUNTY AND THE NORTHWESTERLY LINE OF THE SOUTHEASTERLY 220.00 FEET OF LOT 59 OF THE SEMI-TROPIC LAND AND WATER COMPANY SUBDIVISION AS PER PLAT RECORDED IN BOOK 6, PAGE 12 OF MAPS, OFFICIAL RECORDS OF SAID COUNTY, SAID POINT BEING NORTH 53°25'18" WEST, 109.99 FEET, MEASURED ALONG THE CENTERLINE OF VIA BELLO DRIVE, FROM THE INTERSECTION WITH THE NORTHERLY PROJECTION OF THE EASTERLY LINE OF PARCEL 1 AS SHOWN ON SAID PARCEL MAP;

THENCE NORTH 53°25'18" WEST ALONG THE NORTHWESTERLY PROLONGATION OF THE CENTERLINE OF SAID VIA BELLO DRIVE, A DISTANCE OF 110.00 FEET TO THE NORTHERLY LINE OF THE SOUTHEASTERLY 330.00 FEET OF SAID LOT 59.

THE SIDELINES OF SAID STRIP OF LAND SHALL BE LENGTHENED OR SHORTENED TO BEGIN AT THE SOUTHERLY LINE OF THE NORTHWESTERLY 110.00 FEET OF THE SOUTHEASTERLY 330.00 FEET OF SAID LOT 59, AND END AT THE NORTHERLY LINE OF THE SOUTHEASTERLY 330.00 FEET OF SAID LOT 59.

CONTAINS 2200 SF (0.051 ACRES) MORE OR LESS.

Vincent Kleppe
VINCENT G. KLEPPE LS 7181

5-9-22
DATE



PREPARED FOR AND ON BEHALF OF THE PRIZM GROUP
P:/TPG/21/21-056/EASEMENT/21-056 EASEMENT.doc

EXHIBIT "B"

PLAT TO ACCOMPANY LEGAL DESCRIPTION

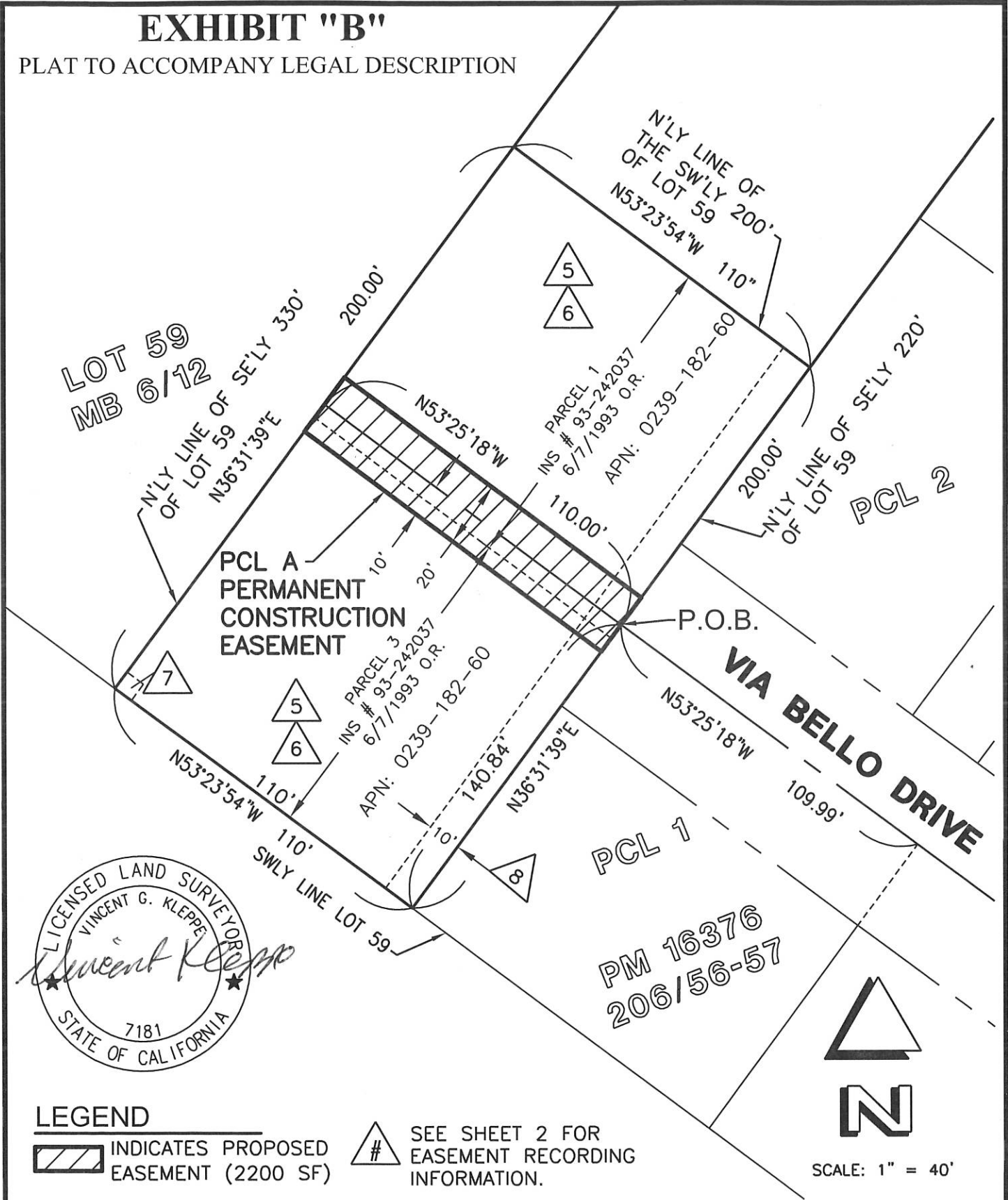

LEGEND

 INDICATES PROPOSED EASEMENT (2200 SF)

 SEE SHEET 2 FOR EASEMENT RECORDING INFORMATION.



DRAWN BY: VGG
 DATE: 5-9-22
 JOB. NO.: 21-056
 FILE: P:\TPG\21\21-056\EASEMENT\21-056_PCE.DWG

CIVIL ENGINEERS AND LAND SURVEYORS
THE PRIZM GROUP
 • CYRAX 3-D LASER SCANNING
 • GPS & ROBOTIC SURVEYING
 • GEOMATIC ENGINEERING
 • CIVIL ENGINEERING
 • LAND PLANNING
 310 N. COTA ST. SUITE I, CORONA, CA 92878
 PHONE: (951) 737-4406 • www.the-prizm-group.com

EXHIBIT "B"
 PERMANENT
 CONSTRUCTION
 EASEMENT

SHT. NO.
1
 OF 2

EXHIBIT "B"

PLAT TO ACCOMPANY LEGAL DESCRIPTION

- 5 BLANKET EASEMENT FOR WATER LINE,
TELEPHONE, AND ELECTRIC LINES
CONSTRUCTION AND MAINTENANCE PER
DEED RECORDED JUNE 28, 1935 IN
BOOK 1067, PAGE 336 O.R..
- 6 BLANKET EASEMENT FOR ROADS,
HIGHWAYS, UTILITIES, PIPELINES AND
INCIDENTAL PURPOSES PER DEED
RECORDED NOVEMBER 1, 1946 IN BOOK
1971, PAGE 14 O.R..
- 7 EASEMENT IN FAVOR OF
SOUTHERN CALIFORNIA EDISON
PER DOCUMENT RECORDED
MARCH 27, 1963 IN BOOK
5875, PAGE 441 O.R..
- 8 A PRIVATE EASEMENT FOR INGRESS,
EGRESS & PUBLIC UTILITIES PER
DOCUMENT RECORDED FEBRUARY 13,
1962 IN BOOK 5645, PAGE 170
O.R..

DRAWN BY: V GK

DATE: 5-9-22

JOB. NO.: 21-056

FILE: P:\TPG\21\21-056\
EASEMENT\21-056 TCE.DWG

CIVIL ENGINEERS AND LAND SURVEYORS
THE PRIZM
 GROUP

- CYRAX 3-D LASER SCANNING
- GPS & ROBOTIC SURVEYING
- GEOMATIC ENGINEERING
- CIVIL ENGINEERING
- LAND PLANNING

310 N. COTA ST. SUITE I, CORONA, CA 92878
 PHONE: (951) 737-4406 • www.the-prizm-group.com

EXHIBIT "B"
 TEMPORARY
 CONSTRUCTION
 EASEMENT

SHT. NO.

2
 OF 2



**BOARD OF DIRECTORS
STAFF REPORT**

DATE: October 20, 2022
TO: Board of Directors
FROM: Van Jew, Acting General Manager
SUBJECT: WATER SYSTEM INFRASTRUCTURE INSTALL AND CONVEYANCE AGREEMENT WITH LENNAR

BACKGROUND:

Lennar Homes of California, LLC. (“Developer”) is the owner of land located north of Sycamore Avenue, east of Country Club Drive and west of Oakdale Avenue in the City of Rialto, known as the River Ranch. The Developer has subdivided the land into multiple tracts to be developed into single family residential homes within River Ranch. The West Valley Water District (“District”) owns and operates several water facilities within the River Ranch development which the Developer is responsible for reconnecting into the newly constructed infrastructure. The Well 2 Treatment Plant and Well 1 Flush Line, are among the existing facilities which must be tied into the new Well Supply Line and new storm drain system in order to allow for continued operation of the site.

DISCUSSION:

The District and the Developer wish to enter into a Developer-Installed Water System Infrastructure Installation and Conveyance Agreement (“Agreement”) to construct the water facilities needed to connect this well into the well supply line. This Agreement outlines the responsibilities of the Developer in constructing facilities, including insurance, indemnification and bonding requirements as well as conveyance and acceptance of the water system by the District. Attached as Exhibit A is a copy of the Water System Infrastructure Installation and Conveyance Agreement for this development.

FISCAL IMPACT:

No fiscal impact to the District.

STAFF RECOMMENDATION:

Staff recommends that the Board of Directors to authorize entering into an agreement with Lennar Homes of California, LLC pertaining to River Ranch Well 2 Treatment Plant and Well 1 Flush Line Improvements and authorize the Acting General Manager to execute all related documents.

Respectfully Submitted,

Van Jew

Van Jew, Acting General Manager

DG:ls

ATTACHMENT(S):

1. Exhibit A - Water System Infrastructure Installation Agreement

MEETING HISTORY:

10/12/22 Engineering, Operations and Planning Committee REFERRED TO BOARD

EXHIBIT A

WATER SYSTEM INFRASTRUCTURE INSTALLATION AND CONVEYANCE AGREEMENT

This water system infrastructure installation and conveyance agreement (“Agreement”) is entered into and effective as of **October 20, 2022**, by and between **LENNAR HOMES OF CALIFORNIA, LLC** (“Developer”), and **WEST VALLEY WATER DISTRICT** (“District”) who agree as follows:

The Developer is the owner of certain land described as **TRACT 20204** and as more fully (or further) shown on Exhibit "A". In developing this land, the Developer is desirous of obtaining a public water supply adequate for domestic uses and public fire protection purposes and is desirous of integrating that water system into the District’s public water system.

In order to provide facilities for a water supply to said land, it is the intention of the parties to this Agreement that the Developer shall furnish and install those water mains, fire hydrants, service laterals, water meters and valves, valve boxes, and all other appurtenant fittings and facilities required for a complete water system to serve the land shown on Exhibit "A".

In order to implement the foregoing and in consideration of the terms and conditions herein contained, the parties further agree as follows:

1. DESIGN

1.1. Developer shall design and construct, at the Developer's own expense, the water facilities and appurtenances required to serve the development in accordance with final District-approved plans known as **WELL 2 TREATMENT PLANT AND WELL 1 FLUSH LINE IMPROVEMENTS**, as approved and provided at a later date attached herein as Exhibit "B" and in accordance with District-approved design standards and specifications, and the terms and conditions of this Agreement.

1.2. The water system design shall be by a Professional Engineer registered in the State of California, and in accordance with the District's most recent Rules and Regulations (the “Rules and Regulations”), the District's Standards for Domestic Water Facilities and Standard Drawings herein included by reference, all applicable District ordinances and policies and all City, County of San Bernardino, State of California, and Federal laws, ordinances, rules, regulations, codes and other legal requirements of all government bodies having jurisdiction over said construction and property (all of the foregoing requirements in this paragraph being collectively referred to herein at times as “Legal Requirements”).

1.3. The District, at Developer's expense, shall review Developer's plans for the purpose of ensuring the adequacy of the design and conformance with the District's standards and specifications. The District reserves the right to add, delete, modify, change or amend any or all the plans and specifications.

1.4. In the event that the property to be developed includes multiple residential, condominiums, commercial or industrial uses, all site plans, grading plans, and any available plumbing plot plans shall be furnished to the District by Developer.

1.5. The District makes no warranties as to the correctness, accuracy or completeness of the plans and specifications. The accuracy, adequacy, suitability, and correctness of the water system design shall be the sole responsibility of the Developer.

2. CONSTRUCTION

2.1. Developer shall perform, or caused to be performed, all construction of the water system infrastructure installation pursuant to the approved water system plans, and all Legal Requirements.

2.2 The performance of this Agreement shall commence within ninety (90) calendar days from the date of this Agreement and shall be completed within one (1) year from the estimated construction start date.

2.3. Time is of the essence in this Agreement; provided that, in the event good cause is shown therefore, the general manager of the District (“General Manager”) may extend the time for completion of the water system installation. Any such extension may be granted without the notice to Developer's surety, and extensions so granted shall not relieve the surety's liability on the bond to secure faithful performance of this Agreement. The General Manager shall be the sole and final judge as to whether or not good cause has been shown to entitle Developer to an extension.

2.4. The Developer and its contractor and subcontractors shall attend a preconstruction meeting with the District at the District's headquarters no less than five (5) working days prior to commencement of construction.

2.5. No work on water facilities shall commence prior to the completion of all required curbs and gutters.

3. LICENSES AND PERMITS

3.1. Developer, and all of Developer’s contractors and subcontractors warrants it possesses, or shall obtain, and maintain during the term of this Agreement any and all licenses, permits, qualifications, insurance and approval of whatever nature that are legally required of Developer, its contractors, and all subcontractors to practice its profession, skill or business.

3.2. The work to be performed under this Agreement, except meter installations, shall be performed by Developer, or a contractor or subcontractor who is pre-approved by the District and is licensed under the laws of the State of California in the specialty Class of "C-34" Pipeline or Class "A" General Engineering. A copy of the contract between Developer and the selected pre-approved contractor and all subcontractors shall be submitted to the District for review and approval.

3.3. Excavation/resurfacing permits shall be secured by Developer at Developer's expense. Permits/easements to install, maintain and operate water system facilities in private property shall be secured by Developer at Developer's own expense prior to construction.

3.4. Developer shall, at Developer's own expense, be responsible for obtaining and adhering to a National Pollution Discharge Elimination System (NPDES) permit from the Regional Water Quality Board as required for construction or pipeline flushing and disinfection.

4. INSURANCE REQUIREMENTS

4.1. The following insurance requirements have been adopted by the District and shall be applicable to this Agreement. These requirements supersede the insurance requirements set forth in any other reference of the District, and to the extent of any conflict, the specified requirements herein shall prevail.

4.2. Developer shall ensure that Developer's contractors conform to the following insurance requirements and that all required documents are submitted to the District at the time of Agreement submittal: Developer shall ensure that its contractors and all subcontractors shall purchase and maintain insurance in amounts equal to the requirements set forth in (a) through (d) below, and shall not commence work under this Agreement until all insurance required under this heading is obtained in a form acceptable to the District, nor shall Developer allow any contractor or subcontractor to commence construction pursuant to a contract or subcontract until all insurance required of the contractor and any subcontractors has been obtained.

a. General Liability: Developer shall ensure that its contractor and all subcontractors shall maintain during the life of this Agreement, a standard form of either Comprehensive General Liability insurance or Commercial General Liability insurance ("General Liability Insurance") providing the following minimum limits of liability: Combined single limit of \$1.0 million per occurrence for bodily injury, including death, personal injury, and property damage with \$2.0 million minimum aggregate, separate for this project as evidenced by endorsement. The insurance shall include coverage for each of the following hazards: Premises-Operations; Owners and Contractors Protective; Broad Form Property Damage contractual for Specific Contract; Severability of Interest or Cross-Liability; XCU Hazards; and Personal Injury – With the "Employee" Exclusive Deleted.

b. Automotive/Vehicle Liability Insurance: Developer shall ensure that its contractor and all subcontractors shall maintain a policy of automotive/vehicle liability insurance on a commercial auto liability form covering owned, non-owned and hired automobiles providing the following minimum limits of liability: Combined single limit of liability of \$1.0 million per accident for Bodily Injury, Death and Property Damage ("Automotive/Vehicle Liability Insurance").

c. Workers' Compensation Insurance: Developer shall ensure that its contractor and all subcontractors shall provide such workers' compensation insurance with statutory minimum amounts of coverage, as required by the California *Labor Code* and other applicable law, and including employer's liability insurance with a minimum limit of \$1,000,000.00 ("Workers' Compensation Insurance"). Such Workers' Compensation Insurance shall be endorsed to provide for a waiver of subrogation against the District.

d. Excess Liability: Developer shall ensure that its contractor and all subcontractors shall provide a policy providing excess coverage in a face amount necessary when

combined with the primary insurance, to equal the minimum requirements for General Liability Insurance and Automotive/Vehicle Liability Insurance.

4.3. The insurances provided for in Section 4.2 and its subsections above are subject to all of the following conditions:

a. The insurance shall be issued and underwritten by insurance companies acceptable to the District, and shall be licensed by the State of California to do business on the lines of insurance specified. The insurers must also have an "A-" Policyholder's rating" and a "financial rating" of at least Class VII in accordance with the most current A.M. Best's Rating Guide.

b. Developer's contractor and subcontractors may satisfy the limit requirements in a single policy or multiple policies. Any such additional policies written as excess insurance shall not provide any less coverage than that provided by the first or primary policy.

c. Any costs associated with a self-insured program, deductibles, or premium rating programs that determine premium based on loss experience shall be for the account of Developer, Developer's contractor and subcontractors, and the District shall not be required to participate in any such loss. If any such programs exist, Developer, Developer's contractor and subcontractors, agree to protect and defend the District in the same manner as if such cost provisions were not applicable.

d. Developer shall ensure that its contractor and all subcontractors shall have presented at the time of execution of the Agreement, the original policies of insurance and a certificate of insurance naming the District as the certificate holder and that such coverage is in force and complies with the terms and conditions outlined herein.

e. If an insurance policy contains a general policy aggregate of less than the minimum limits specified, then the policy coverage shall be written with limits applicable solely to this Agreement, as specified, and shall not be reduced by or impaired by any other claims arising against Developer. These policy limits shall be set forth by separate endorsement to the policy.

4.4. Each such policy of General Liability Insurance and Automotive/Vehicle Liability Insurance shall contain endorsements providing the following:

a. The District, their board members, officers, agents, employees, consultants, and engineers, are hereby declared to be additional insureds under the terms of this policy, but only with respect to the operations of the Developer at or upon any of the premises of the District in connection with the Agreement with the District, or acts or omissions of the additional insureds in connection with, but limited to its general supervision or inspection of said operations and save for any claims arising from the sole negligence or sole willful misconduct the District.

b. No policy shall be canceled, limited, materially altered, or non-renewed by the insurer until thirty (30) days after receipt by the District of a written notice of such cancellation or reduction in coverage.

c. This insurance policy is primary insurance and no insurance held or owned by the designated additional insureds shall be called upon to cover a loss under this policy.

5. BONDING REQUIREMENTS

5.1. Developer shall provide a Contractor’s proposal based on the District approved water system plans. The Developer will provide a Contractor’s proposal and will be submitted to the District for review and approval at a later date (Exhibit “C”), and shall be used as the basis for bonding requirements for the water system described in the plans provided to the District by the Developer and approved for construction by the District.

5.2. Performance Bond: The Contractor’s proposal from the Developer for **WELL 2 TREATMENT PLANT AND WELL 1 FLUSH LINE IMPROVEMENTS**, is **TBD – DEVELOPER WILL PROVIDE BOND AMOUNT AT A LATER DATE – DOLLARS and 00/100 (\$0.00)**. Developer shall and by this Agreement does guarantee the Developer's faithful performance of this Agreement and all of its terms and conditions. The Developer shall provide the District with a performance bond from a surety institution licensed by the State of California and authorized to do and doing business in said State, valid and renewable until such improvements are accepted by the District. The performance bond shall be in the amount of **DEVELOPER WILL PROVIDE BOND AMOUNT AT A LATER DATE – TBD – DOLLARS and 00/100 (\$0.00)** equal to 100 percent of the approved Developer’s estimate.

5.3. Warranty Bond: The Developer’s pre-approved contractor shall furnish a two-year warranty bond for all work completed in accordance with the approved plans. The approved plans will be provided at a later date (Exhibit "B"). Before District's acceptance of the completed water facilities and appurtenances, such facilities and appurtenances shall be free from any and all liens and encumbrances and free from any and all defects in the materials or construction thereof. The two-year warranty shall be a warranty bond beginning on the date of acceptance of the water facilities by the District.

6. MATERIALS

6.1. The water system facilities to be installed pursuant to this Agreement shall become an extension of the distribution system of the District. All materials used must conform to District specifications for such materials pursuant to all applicable Legal Requirements.

7. NOTICES

7.1. All notices herein required shall be in writing, and delivered in person or sent by registered mail, postage prepaid.

7.2. Notices required shall be given to the **District** addressed as follows:

WEST VALLEY WATER DISTRICT
Attn: General Manager
Post Office Box 920
Rialto, CA 92377
RE: WELL 2 TREATMENT PLANT AND WELL 1 FLUSH LINE
IMPROVEMENTS

7.3. Notices required shall be given to **Developer** addressed as follows:

LENNAR HOMES OF CALIFORNIA, LLC
ATTENTION: RYAN COMBE
980 MONTECITO, SUITE 302
CORONA, CA
RE: WELL 2 TREATMENT PLANT AND WELL 1 FLUSH LINE
IMPROVEMENTS

7.4. Notices required shall be given to **Surety** addressed as follows:

SURETY NAME:
ADDRESS
RE: WELL 2 TREATMENT PLANT AND WELL 1 FLUSH LINE
IMPROVEMENTS

7.5. Provided that any party or Surety may change such address by notice in writing to the other party, and thereafter, notices shall be addressed and transmitted to the new address.

7.6. The Developer or its contractor shall provide the District forty-eight (48) hours advance notice of request for inspection or testing.

7.7. The District is closed on the holidays listed in Exhibit "D".

8. NOTICE TO PROCEED TO CONSTRUCT WATER SYSTEM FACILITIES

8.1. Upon acceptance of the insurance and aforementioned bonds in the amounts provided herein and approval by the District and upon payment of all applicable charges, the Agreement shall be signed by Developer and the District. The District shall return an original copy of the signed Agreement with a letter to Developer giving notice to proceed to construct the water system facilities.

9. INSPECTION

9.1. It is understood that the sole purpose and intent of the District's inspection and testing is to validate that the materials, workmanship, and construction of the water facilities are in compliance with the District-approved final plans, the District's Rules and Regulations, the Standards for Domestic Water Facilities, the Standard Drawings, and all other applicable District requirements. Developer acknowledges and represents that it assumes full and sole responsibility for the safety and management of the project.

9.2. Developer shall at all times maintain proper facilities and provide safe access for inspection by the District to all parts of the work and to the shops wherein the work is in preparation. Additionally, in connection with the performance of this Agreement, the District shall have the authority to enter the work site at any time for the purpose of identifying the existence of conditions, either actual or threatened, that may present a danger of hazard to any and all employees. Developer agrees that the District, in its sole authority and discretion, may order the immediate abatement of any and all conditions that may present an actual or threatened danger

or hazard to any and all employees at the work site. Furthermore, Developer acknowledges the provisions of California *Labor Code* Section 6400 et seq., which requires that employers shall furnish employment and a place of employment that is safe and healthful for all employees working therein. In the event the District identifies the existence of any condition that presents an actual or threatened danger or hazard to any or all employees at the work site, the District is hereby authorized to order an immediate abatement of that condition.

9.3. All work and materials shall be subject to inspection, testing, and acceptance by the District at Developer's expense. In the event Developer arranges to have materials fabricated for the project, Developer may be required to arrange for the District to inspect that material during fabrication at Developer's expense.

9.4. All material fabrications shall be preapproved by the District and must conform to District standards and specifications.

9.5. The District's inspectors shall have full, unlimited access to perform continuous inspection and have the authority to stop work at any time, by written notice, without any liability whatsoever to the District, if, in the inspectors' judgment, the work called for by this Agreement, or the District approved plans, or the specifications is not being installed or performed in a satisfactory and workmanlike manner according to District's standards and specifications and/or in the event the materials do not comply with the District's standards and specifications.

9.6. Final acceptance of all material to be purchased or fabricated by Developer under this Agreement shall be made only with the prior approval of the District. Approval by the District, however, shall not operate to relieve the material supplier or Developer of any guarantees, warranties, or the duty of compliance with any of the requirements of the approved plans and specifications or of this Agreement. All construction pursuant to this Agreement shall be inspected pursuant for conformity with District requirements. Developer shall pay actual costs for inspections.

10. TESTING AND DISINFECTION

10.1. All water system facilities and components constructed pursuant to this Agreement shall adhere to all requirements for testing, disinfection, and flushing pursuant to District standards and Legal Requirements.

11. RELOCATIONS, RECONSTRUCTIONS, AND DAMAGES

11.1. Developer accepts the responsibility for and the costs occasioned by any reconstruction, relocation, damages to, or changes of water services or facilities caused or contributed to directly or indirectly by any subsequent changes in the location of any of said facilities or water meters or water services.

12. AS-CONSTRUCTED DOCUMENTATION

12.1. In order for the District to accept the facilities, Developer shall provide all required documentation as specified in the Standards for Domestic Water Facilities, including As-Built drawings.

13. INDEMNIFICATION

13.1. Developer hereby agrees to and shall protect, defend, indemnify and hold the District and its board members, officers, agents, employees, and engineers free and harmless from any and all liability losses, damages, claims, liens, demands and cause of action of every kind and character including, but not limited to, the amounts of judgments, penalties, interests, court costs, attorney's/legal fees, and all other expenses incurred by the District arising in favor of any party, including claims, liens, debts, demands for lost wages or compensation, personal injuries, including employees or the District, death or damages to property (including property of the District) and without limitation by enumeration, all other claims or demands of every character occurring or in any way incident to, in connection with or arising directly or indirectly out of the obligations herein undertaken or out of the operations conducted by Developer save and except claims or litigation arising through the sole negligence or sole willful misconduct of the District or the District's agents and employees. Developer shall investigate, handle, respond to, provide defense for and defend any such claims, demand, or suit at the sole expense of Developer even if the claim or claims alleged are groundless, false or fraudulent. Developer agrees to, and shall defend the District and its members, directors, officers, agents, employees, and engineers from any suits or actions at law or in equity for damages caused, or alleged to have been caused, by reason of any of the aforesaid operations, provided as follows:

a. That the District does not and shall not waive any rights against Developer which it may have by reason of the aforesaid hold harmless agreement, because of the acceptance by the District, or the deposit with District by Developer, or any of the insurance policies described in this Agreement.

b. That the aforesaid hold harmless agreement by Developer shall apply to all damages and claims for damages of every kind suffered, or alleged to have been suffered, by reason of any or the aforesaid operations referred to in this subsection, regardless of whether or not District has prepared, supplied water system installation, or regardless of whether or not such insurance policies shall have been determined to be applicable to any such damages or claims for damages.

This provision is not intended to create any cause of action in favor of any third party against Developer or the District or to enlarge in any way Developer's liability but is intended solely to provide for indemnification of the District from liability for damage or injuries to third persons or property arising from Developer's performance hereunder.

13.2. Neither Developer nor any of Developer's agents, contractors or subcontractors are, or shall be, considered to be agents of the District in connection with the performance of Developer's obligations under this Agreement.

14. REPAIR OR RECONSTRUCTION OF DEFECTIVE WORK

14.1. If, within a period of two years after final acceptance of the work performed under this Agreement, any structure or part of any structure furnished and/or installed or constructed, or caused to be installed or constructed by Developer, or any of the work done under this Agreement, fails to fulfill any of the requirement of this Agreement or the specifications referred to herein, Developer shall, without delay and without any cost to District, repair or replace or reconstruct

any defective or otherwise unsatisfactory part or parts of the work structure. Should Developer fail to act promptly or in accordance with this requirement, or should the exigencies of the situation as determined by the District in the exercise of its sole discretion require repair, replacement or reconstruction before Developer can be notified, District may, at its option, make the necessary repairs or replacements or perform the necessary work, and Developer shall pay to the District the actual cost of such repairs.

15. COSTS AND FEES

15.1. Developer shall be responsible for all fees and deposits as required by the District. All fees and deposits, shall be paid in full prior to the execution of this Agreement and before construction can take place.

15.2. Any additional costs and fees shall be paid in full prior to conveyance and acceptance of the water system.

16. CONVEYANCE AND ACCEPTANCE OF WATER SYSTEM

16.1. Upon completion of the water system in accordance with the approved water plans and submission of the required documentation, the Developer shall convey the water system to the District.

16.2. The Developer shall be responsible for insuring the pre-approved contractor furnish an irrevocable letter of credit to the District or a warranty bond (One Hundred (100%) of Developer's estimate) for a period of two years as stated in Sections 5.3 of this Agreement, as-built drawings with contractor redlines and AutoCAD files, materials list with quantities, labor, equipment, and materials, water system cost breakouts, compaction test report signed and sealed by a California Registered Engineer, notice of completion filed with San Bernardino County Recorder, fire flow tests of all hydrants, all required easements for water facilities and unconditional financial release from subcontractors and material providers, Upon compliance with all the terms and conditions of this Agreement, the District shall prepare the conveyance agreement accepting the water facilities and forward same to the address provided herein. Title to the ownership of said facilities and appurtenances shall thereby be conveyed to the District. The District shall thereafter operate and maintain said facilities so as to furnish water service to the development (Exhibit "A") in accordance with the District's ordinances, policies and Rules and Regulations.

17. PERMANENT WATER SERVICE

17.1. In no event shall permanent water services be provided to Developer's installed system until all applicable charges and fees have been paid by Developer and all facilities have been conveyed, free of all encumbrances, to the District, including any easements which may be required. Such conveyance shall occur in a timely manner in accordance with the terms of this Agreement.

18. BREACH OR DEFAULT OF AGREEMENT

18.1. If Developer refuses or fails to obtain prosecution of the work, or any severable part thereof, with such diligence as will insure its completion within the time specified, or any extension thereof, or fails to obtain completion of said work within such time, or if Developer should be adjudged as bankrupt, or Developer should make a general assignment for the benefit of Developer's creditors, or if a receiver should be appointed in the event of Developer's insolvency, or if Developer, or any of Developer's contractors, subcontractors, agents or employees, should violate any of the provisions of this Agreement, the District's General Manager or the General Manager's designee may serve written notice upon Developer and Developer's surety of breach of this Agreement, or of any portion therefore, and default of Developer.

18.2. In the event of any such notice, Developer's surety shall have the duty to take over and complete the work and the improvement herein specified; provided, however, that if the surety, within five (5) days after the serving upon of such notice of breach, does not give the District written notice of its intention to take over the performance of the contract, and does not commence performance thereof within five (5) days after notice to the District of such election, District may take over the work and prosecute the same to completion, by contract or by any other method District may deem advisable, for the account and at the expense of Developer, and Developer's surety shall be liable to the District for any excess cost or damages occasioned District thereby; and, in such event, District, without liability for so doing, may take possession of, and utilize in completing the work, such materials, appliances, plant and other property belonging to Developer as may be on the site of the work and necessary therefore.

19. SUCCESSORS BOUND

19.1. This Agreement shall be binding upon and inure to the benefit of each of the parties and their respective legal representatives, successors, heirs, and assigns.

20. ENFORCEMENT OF PROVISIONS

20.1. The District's failure to enforce any provisions of this Agreement or the waiver thereof in any instance shall not be construed as a general waiver or relinquishment on its part of any such provision, but the same shall nevertheless be and remain in full force and effect.

[SIGNATURES ON NEXT PAGE]

IN WITNESS WHEREOF, the parties hereto execute this Agreement.

WEST VALLEY WATER DISTRICT

By: _____ Date: _____
Van Jew, Acting General Manager

DEVELOPER:
Lennar Homes of California, LLC
a California limited liability company
(as successor-in-interest by conversion to Lennar Homes of California, Inc.)

By: _____ Date: _____
Authorized Agent

Exhibit A

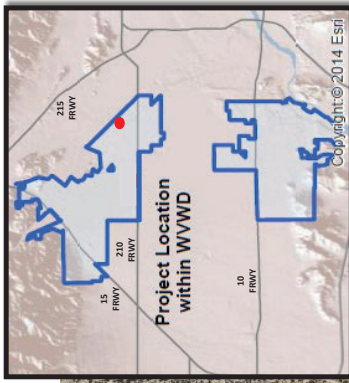

Exhibit B

IN THE CITY OF RIALTO

WATER IMPROVEMENT PLANS

~ TRACT MAP No. 20204 ~

WELL 2 TREATMENT PLANT and WELL 1 FLUSH LINE IMPROVEMENTS

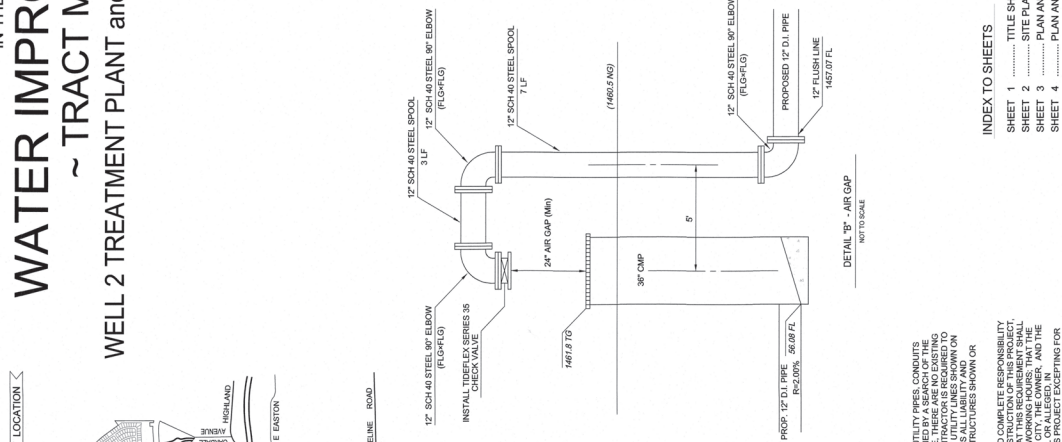
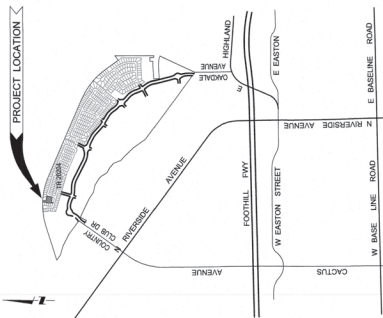

NOTICE TO CONTRACTOR(S)

THE EXISTENCE AND LOCATION OF ANY UNDERGROUND UTILITY PIPES, CONDUITS OR STRUCTURES SHOWN ON THESE PLANS WERE OBTAINED BY A SEARCH OF THE RECORDS OF THE CITY OF RIALTO AND THE RECORDS OF THE COUNTY OF SAN BERNAARDINO, CALIFORNIA, EXCEPT AS SHOWN ON THESE PLANS. THE CONTRACTOR IS REQUIRED TO TAKE DUE PRECAUTIONARY MEASURES TO PROTECT THE UTILITY LINES SHOWN ON THESE PLANS. THE CONTRACTOR SHALL BE RESPONSIBLE FOR OBTAINING ALL NECESSARY PERMITS AND FOR THE PERFORMANCE OF ALL WORK ON THIS PROJECT EXCEPTING FOR THE WORK SHOWN ON THESE DRAWINGS.

CONTRACTOR AGREES THAT HE SHALL ASSUME SOLE AND COMPLETE RESPONSIBILITY FOR THE SAFETY OF ALL PERSONS AND PROPERTY, THAT THE REQUIREMENT SHALL BE MET BY THE CONTRACTOR TO OBTAIN ALL NECESSARY PERMITS AND TO OBTAIN ALL NECESSARY INSURANCE COVERAGE. THE CONTRACTOR SHALL BE RESPONSIBLE FOR THE SAFETY OF ALL PERSONS AND PROPERTY AND SHALL BE RESPONSIBLE FOR THE SAFETY OF ALL PERSONS AND PROPERTY AND SHALL BE RESPONSIBLE FOR THE SAFETY OF ALL PERSONS AND PROPERTY. THE CONTRACTOR SHALL BE RESPONSIBLE FOR THE SAFETY OF ALL PERSONS AND PROPERTY AND SHALL BE RESPONSIBLE FOR THE SAFETY OF ALL PERSONS AND PROPERTY.

MONUMENT PRESERVATION NOTE

SURVEY MONUMENTS THAT EXIST AS SHOWN ON RECORD MAPS, HIGHWAY MAPS, OR SURVEY MONUMENTS WITHIN THE CONSTRUCTION AREA, SHALL BE PRESERVED AND PROTECTED BY THE CONTRACTOR. THE CONTRACTOR SHALL BE RESPONSIBLE FOR THE SAFETY OF ALL PERSONS AND PROPERTY AND SHALL BE RESPONSIBLE FOR THE SAFETY OF ALL PERSONS AND PROPERTY. THE CONTRACTOR SHALL BE RESPONSIBLE FOR THE SAFETY OF ALL PERSONS AND PROPERTY AND SHALL BE RESPONSIBLE FOR THE SAFETY OF ALL PERSONS AND PROPERTY.

CONSTRUCTION CONTRACTOR AGREES THAT HE SHALL ASSUME SOLE AND COMPLETE RESPONSIBILITY FOR THE SAFETY OF ALL PERSONS AND PROPERTY, THAT THE REQUIREMENT SHALL BE MET BY THE CONTRACTOR TO OBTAIN ALL NECESSARY PERMITS AND TO OBTAIN ALL NECESSARY INSURANCE COVERAGE. THE CONTRACTOR SHALL BE RESPONSIBLE FOR THE SAFETY OF ALL PERSONS AND PROPERTY AND SHALL BE RESPONSIBLE FOR THE SAFETY OF ALL PERSONS AND PROPERTY.

WATER LINE CONSTRUCTION NOTES

- ALL WORK SHALL BE PERFORMED IN ACCORDANCE WITH THESE PLANS AND SPECIFICATIONS AND WEST VALLEY WATER DISTRICT'S STANDARDS FOR DOMESTIC WATER FACILITIES.
- THE CONTRACTOR SHALL ARRANGE FOR A PRE-CONSTRUCTION MEETING WITH THE WEST VALLEY WATER DISTRICT AT LEAST ONE WEEK PRIOR TO BEGINNING CONSTRUCTION.
- CONTRACTOR SHALL OBTAIN ALL NECESSARY PERMITS AND INSURANCE COVERAGE PRIOR TO BEGINNING WORK. THE CONTRACTOR SHALL BE RESPONSIBLE FOR OBTAINING ALL NECESSARY PERMITS AND FOR THE PERFORMANCE OF ALL WORK ON THIS PROJECT EXCEPTING FOR THE WORK SHOWN ON THESE DRAWINGS.
- CONTRACTOR SHALL ASSUME SOLE AND COMPLETE RESPONSIBILITY FOR JOB SITE CONDITIONS DURING THE COURSE OF CONSTRUCTION OF THIS PROJECT INCLUDING SAFETY OF THE PUBLIC. THE CONTRACTOR SHALL BE RESPONSIBLE FOR OBTAINING ALL NECESSARY PERMITS AND FOR THE PERFORMANCE OF ALL WORK ON THIS PROJECT EXCEPTING FOR THE WORK SHOWN ON THESE DRAWINGS.
- CONTRACTOR SHALL BE RESPONSIBLE FOR ANY DAMAGE TO EXISTING UTILITIES RESULTING DIRECTLY OR INDIRECTLY FROM CONSTRUCTION OPERATIONS, WHETHER OR NOT SUCH DAMAGE IS SHOWN ON THESE PLANS.
- CONTRACTOR SHALL MAINTAIN ACCESS TO ALL ADJACENT PROPERTIES AND TO ALL EXISTING UTILITIES LINES PRIOR TO EXCAVATING. THE CONTRACTOR SHALL MAKE SURE THAT ALL EXISTING UTILITIES LINES ARE PROTECTED AND NOT DAMAGED.
- PIPE TRENCHES SHALL BE EXCAVATED TRUE TO LINE AND GRADE IN ACCORDANCE WITH THE PLANS AND SPECIFICATIONS. THE CONTRACTOR SHALL MAINTAIN THE TRENCHES TO THE FULL DEPTH AND WIDTH SPECIFIED AND SHALL MAINTAIN MATERIAL WITH A MINIMUM SAND EQUIVALENT OF 30.
- NO PIPE SHALL BE INSTALLED ON FILL MATERIAL WITHOUT FIRST MEETING IN-PLACE COMPACTED TO THE FULL DEPTH AND WIDTH SPECIFIED AND SHALL MAINTAIN MATERIAL WITH A MINIMUM SAND EQUIVALENT OF 30.
- CONTRACTOR SHALL BE RESPONSIBLE FOR OBTAINING ALL NECESSARY PERMITS AND FOR THE PERFORMANCE OF ALL WORK ON THIS PROJECT EXCEPTING FOR THE WORK SHOWN ON THESE DRAWINGS.
- CONTRACTOR SHALL BE RESPONSIBLE FOR OBTAINING ALL NECESSARY PERMITS AND FOR THE PERFORMANCE OF ALL WORK ON THIS PROJECT EXCEPTING FOR THE WORK SHOWN ON THESE DRAWINGS.

WATER LINE CONSTRUCTION NOTES (Cont.)

- CONSTRUCTION SHALL NOT COMMENCE UNTIL TWO (2) YEARS OF THE DISTRICT APPROVAL DATE. THIS PLAN SHALL BE SUBMITTED TO THE DISTRICT FOR REVIEW AND APPROVAL.
- WATER LINES TO BE INSTALLED ONLY AFTER THE COMPLETION OF CONCRETE CURB AND GUTTER.
- CONTRACTOR SHALL FURNISH 3" DIA. WARRANTY BOND FOR ALL WATER FACILITIES INSTALLED UNDER THESE PLANS.
- ALL DUCTILE IRON PIPE SHALL BE RESTRAINED PER DISTRICT STANDARD W-30.
- ALL DUCTILE IRON JOINTS, BENDS, AND FITTINGS SHALL BE MECHANICALLY RESTRAINED AS INDICATED ON THE PLANS.
- WATER LINE SHUTDOWS ARE ONLY SCHEDULED THROUGH TUESDAY THROUGH THURSDAY BASED ON DISTRICT AVAILABILITY.
- WATER METERS WILL NOT BE RELEASED UNTIL COMPACTION REPORTS ARE RECEIVED AND APPROVED BY THE DISTRICT.
- ALL WORK SHALL BE COMPLETED PRIOR TO THE DISTRICT APPROVAL DATE. ANY CHANGES, SUBSTITUTIONS, OR OMISSIONS FROM THESE PLANS MUST FIRST BE APPROVED BY THE DISTRICT BEFORE COMMENCING.
- ALL WORK SHALL BE COMPLETED PRIOR TO THE DISTRICT APPROVAL DATE. ANY CHANGES, SUBSTITUTIONS, OR OMISSIONS FROM THESE PLANS MUST FIRST BE APPROVED BY THE DISTRICT BEFORE COMMENCING.
- ALL WORK SHALL BE COMPLETED PRIOR TO THE DISTRICT APPROVAL DATE. ANY CHANGES, SUBSTITUTIONS, OR OMISSIONS FROM THESE PLANS MUST FIRST BE APPROVED BY THE DISTRICT BEFORE COMMENCING.

DESIGN

THIS CERTIFICATE THAT THESE PLANS AND SPECIFICATIONS HAVE BEEN DESIGNED UNDER THE DIRECT SUPERVISION OF A CIVIL ENGINEER LICENSED IN THE STATE OF CALIFORNIA AND ARE IN ACCORDANCE WITH THE STANDARDS AND SPECIFICATIONS FOR WATER MAINS AS SET FORTH IN CHAPTER 16, CALIFORNIA WATERWORKS STANDARD OF THE STATE OF CALIFORNIA.

SIGNATURE OF DESIGN ENGINEER: _____ TITLE: _____ DATE: _____

WATER

THIS CERTIFICATE THAT THESE PLANS AND SPECIFICATIONS HAVE BEEN REVIEWED BY AND ACCEPTED BY THE WEST VALLEY WATER DISTRICT AND THAT THE DISTRICT IS WILLING AND ABLE TO SUPPLY WATER TO SERVE THIS LOCATION.

SIGNATURE: _____ TITLE: _____ DATE: _____

WATER CONSTRUCTION ITEMS	QUANTITIES
FURNISH & INSTALL 12" DUCTILE IRON PIPE, CLASS 350, PER WEST VALLEY WATER DISTRICT SPECIFICATIONS	1,096 LF
FURNISH & INSTALL 18" DUCTILE IRON PIPE, CLASS 350, PER WEST VALLEY WATER DISTRICT SPECIFICATIONS	110 LF
FURNISH & INSTALL 12" DUCTILE IRON FITTING (BEND) AS NOTED	9 EA
FURNISH & INSTALL 18" DUCTILE IRON FITTING (BEND) AS NOTED	2 EA
FURNISH & INSTALL 4" BLOW-OFF ASSEMBLY PER WEST VALLEY WATER DISTRICT STANDARD DRAWING No. W7	2 EA
FURNISH & INSTALL 24" SCHEDULE 40 STEEL CONDUCTOR TUBE, PER WEST VALLEY WATER DISTRICT STANDARD DRAWING No. W-23	20 LF

WEST VALLEY WATER DISTRICT WATERLINE IMPROVEMENTS FOR WELL 1 FLUSH LINE AND WELL 2 TREATMENT TRACT NUMBER	5.10.a
Zone 4 Pressure Zone: _____ VWP Number: D 220 31	SHEET 1 OF 4 SHEETS

OWNER
 LENNAR HOMES OF CA, Inc.
 980 MONTECITO DRIVE #302
 CORONA, CALIFORNIA 92991
 CONTACT: Ms. CAREY ADAMS
 (951) 817-3552

SOILS ENGINEER
 TERRA SCIENCES, Inc.
 40880-M COUNTY CENTER DRIVE
 TEMECULA, CALIFORNIA 92591
 CONTACT: Mr. JIM LARWOOD, CEG
 (951) 860-9271

UNDERGROUND SERVICE ALERT
 Call TOLL FREE 1-800-227-2600
 (FOR CURRENT DATA ENTER 60330)

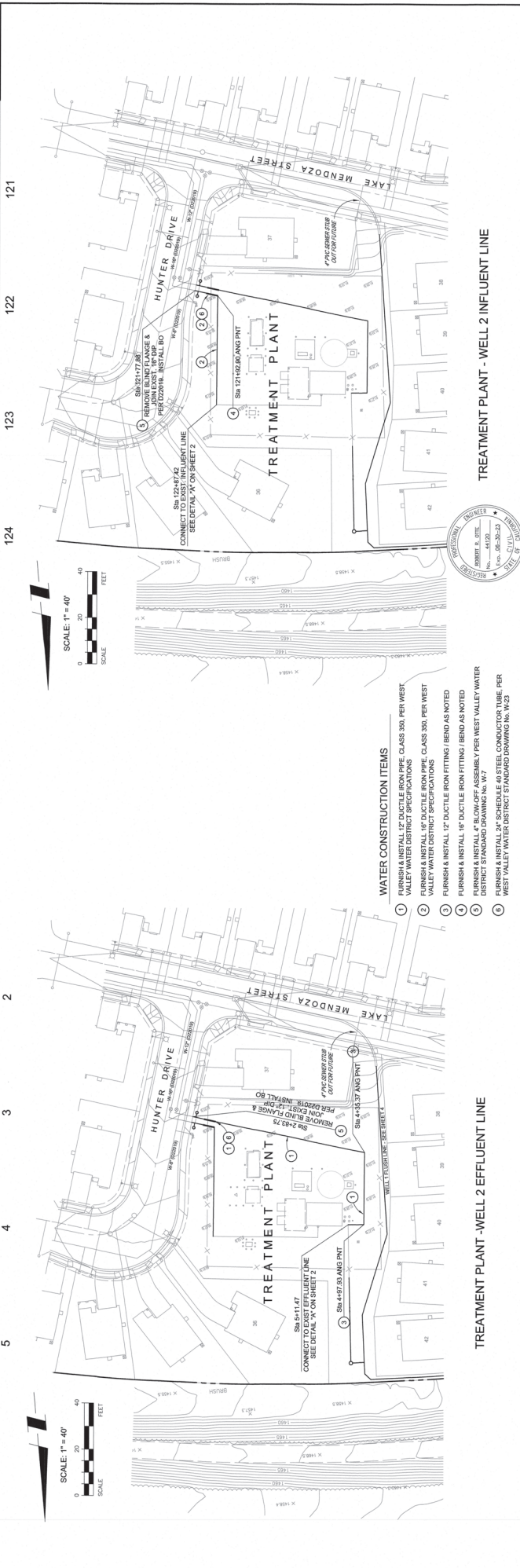
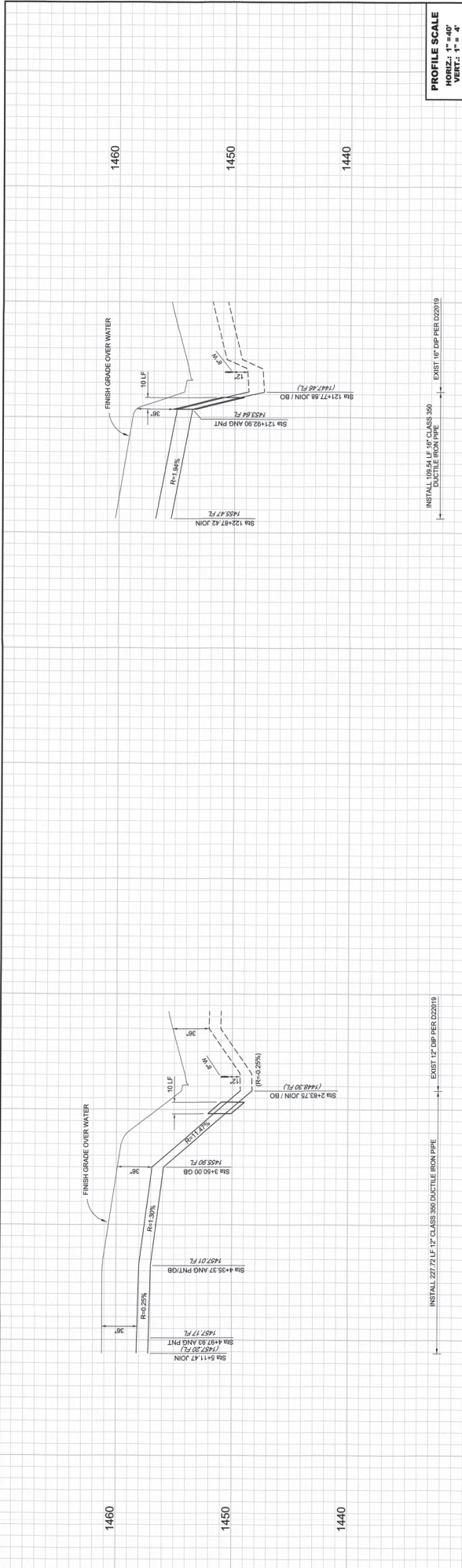

WEST VALLEY WATER DISTRICT

WATERLINE IMPROVEMENTS FOR

WELL FLUSH LINE AND WELL TREATMENT

TRACT NUMBER

ZONE 4

D 220 3 1

WIP Number:

Pressure Zone:

AS SHOWN

Scale:

AS SHOWN

Checked:

Job No.:

Designed:

Drawn:

Date:

Approval:

PROPOSED

Underground Service Afloat

Call Toll Free 1-800-227-5800

CONSTRUCTION CONTRACTOR AGREES THAT IN ACCORDANCE WITH GENERALLY ACCEPTED CONSTRUCTION AND SITE CONDITIONS DURING THE COURSE OF CONSTRUCTION OF THE PROJECT, INCLUDING SAFETY OF ALL PERSONS AND PROPERTY, THE CONTRACTOR SHALL BE RESPONSIBLE FOR OBTAINING ALL NECESSARY PERMITS AND APPROVALS FROM ALL APPLICABLE AGENCIES AND AUTHORITIES. THE CONTRACTOR SHALL BE RESPONSIBLE FOR OBTAINING ALL NECESSARY PERMITS AND APPROVALS FROM ALL APPLICABLE AGENCIES AND AUTHORITIES. THE CONTRACTOR SHALL BE RESPONSIBLE FOR OBTAINING ALL NECESSARY PERMITS AND APPROVALS FROM ALL APPLICABLE AGENCIES AND AUTHORITIES.

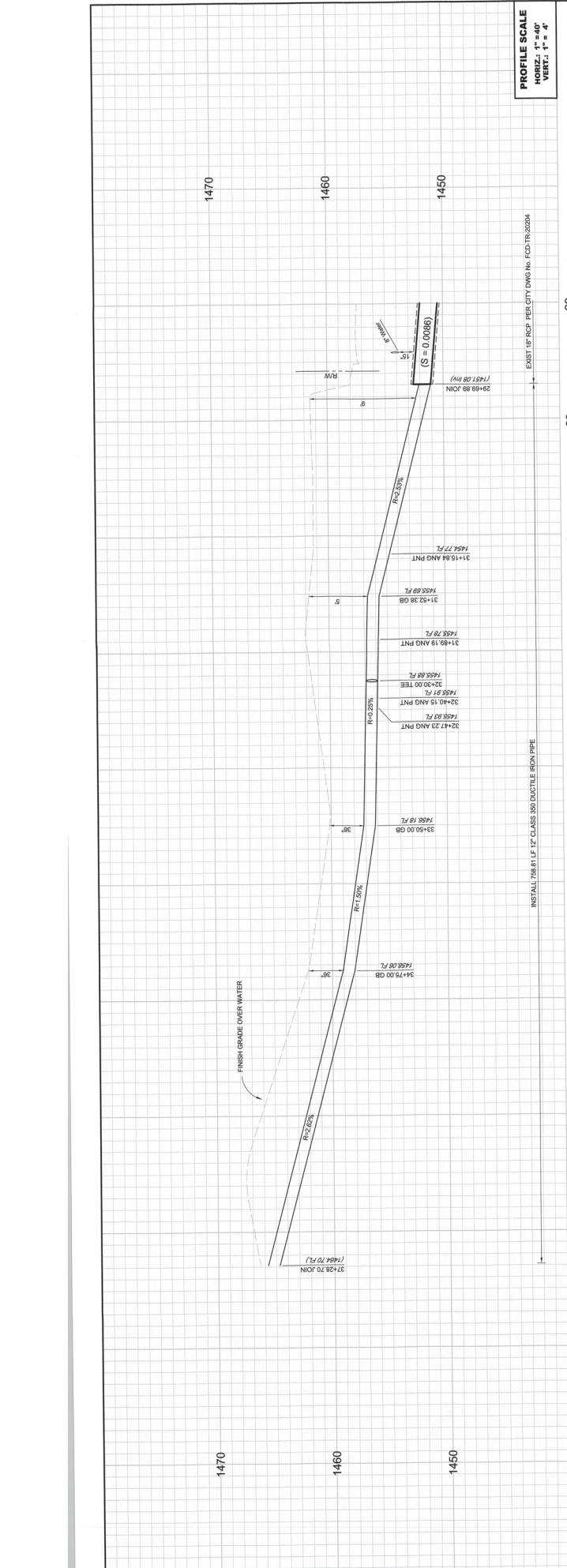

PROFILE SCALE
 HORIZ.: 1" = 40'
 VERT.: 1" = 4'

EXIST. 18" RCP PER CITY DWG No. FCD-TR-20204

INSTALL 756.81 12" CLASS 350 DUCTILE IRON PIPE

FINISH GRADE OVER WATER



WELL 1 and TREATMENT PLANT FLUSH LINE

OTTE BERKELEY GROUP, INC.
 ENGINEER
 No. 41102
 No. 303323

WEST VALLEY WATER DISTRICT
 WATERLINE IMPROVEMENT PLANS FOR
 WELL 1 FLUSHLINE AND WELL 2 TREATMENT
 TRACT NUMBER

APPROVED: _____
 Date: _____

WIP Number: **D 2 2 0 3 1**
 Pressure Zone: **ZONE 4**

Underground Service Alert
 Call TOLL FREE
 1-800-227-2800

CONTRACTOR'S LIABILITY: CONTRACTOR'S LIABILITY FOR THE DESIGN AND CONSTRUCTION OF THIS PROJECT IS LIMITED TO THE DESIGN AND CONSTRUCTION OF THIS PROJECT. CONTRACTOR'S LIABILITY FOR THE DESIGN AND CONSTRUCTION OF THIS PROJECT IS LIMITED TO THE DESIGN AND CONSTRUCTION OF THIS PROJECT. CONTRACTOR'S LIABILITY FOR THE DESIGN AND CONSTRUCTION OF THIS PROJECT IS LIMITED TO THE DESIGN AND CONSTRUCTION OF THIS PROJECT.

Exhibit C

(to be provided at later date)

Exhibit D



**CALENDAR YEAR 2022
HOLIDAY SCHEDULE**

<u>HOLIDAY</u>	<u>DAY OBSERVED</u>
New Year's Day	Friday, December 31, 2021
Martin Luther King Jr. Day	Monday, January 17, 2022
Presidents Day	Monday, February 21, 2022
Memorial Day	Monday, May 30, 2022
Independence Day	Monday, July 4, 2022
Labor Day	Monday, September 5, 2022
Veterans Day	Friday, November 11, 2022
Thanksgiving Day	Thursday, November 24, 2022
Day after Thanksgiving	Friday, November 25, 2022
Day before Christmas	Friday, December 23, 2022
Christmas Day	Monday, December 26, 2022
New Year's Eve	Friday, December 30, 2022



**BOARD OF DIRECTORS
STAFF REPORT**

DATE: October 20, 2022
TO: Board of Directors
FROM: Van Jew, Acting General Manager
SUBJECT: CONTRACT AMENDMENT: CLASSIFICATION AND COMPENSATION STUDY

BACKGROUND:

On July 7, 2022, the Board of Directors approved a ratification to the contract awarded to CPS HR Consultants (CPS) to complete the comprehensive Classification and Compensation Study.

DISCUSSION:

CPS has advised that there is a re-start fee to commence the Classification and Compensation Study (**Exhibit A**). The re-start fee \$8,000 is due to the project being placed on hold, the assigned CPS HR project manager left the organization and the other team members were assigned to other projects. A new project manager has been assigned and most of the previous team members are back on the project. With the passing 4 months, CPS needs to reconcile the new roster, review the previously completed Position Description Questionnaire (PDQ), the PDQ reviewer notes, the interview notes, and select the final list of supervisors to be interviewed to move on to the next steps of the project.

The classification portion of the study is anticipated to be completed by November. Once the classification portion is completed CPS moves on to the compensation aspect of the study. This is anticipated to be completed by March 2023.

This second contract amendment will bring the contract total to \$146,905. Again, the study will satisfy the obligation within the Memorandum of Understanding between West Valley Water District and the International Union of Operating Engineers Local Union #12.

The results of the study will be presented to the District Board, the bargaining group, and employees as appropriate.

FISCAL IMPACT:

Funding is included in FY 2022-23 approved budget.

STAFF RECOMMENDATION:

Staff recommends that the Board of Directors to authorize entering into a contract amendment with CPS HR Consulting in the amount of \$8,000 to address the re-start cost, bringing the total cost of the Comprehensive Classification and Compensation Study to \$146,905.

Respectfully Submitted,

Van Jew

Van Jew, Acting General Manager

VJ:hms

ATTACHMENT(S):

1. EXHIBIT A - WWWD Project Change Order Request

MEETING HISTORY:

10/10/22 Human Resources Committee REFERRED TO BOARD

EXHIBIT A

Project Change Order Request

Project name:

West Valley Water District Classification and Total Compensation Study
--

Requested by:

Date:

Haydee M. Sainz, Human Resources & Risk Manager

8/25/22

Request name:

Request number:

Re-start project after May 2022 hold

2

Change description, reason, and impact:

Description:

In May 2022, the project was placed on hold by the client. In late August 2022, the client requested a re-start to the project. In the intervening time, the assigned CPS HR project manager left the organization and the other team members were assigned to other projects.

We have obtained a new project manager and have workforced most of the previous team members. With the passing of almost 4 months, the team needs to reconcile the new roster, review the previously completed PDQs, the PDQ reviewer notes, the interview notes, and select the final list of supervisors to be interviewed to move on to the next steps of the project.

Impact:

- **Scope:** None
- **Budget:** Additional funding
- **Timeline:** Additional time added to project timeline. Timeline for remainder of classification and compensation project activities will be provided by the end of November after the supervisor interviews are expected to be concluded.

Proposed action:

Amend contract scope, timeline, and pricing.

- **SCOPE CHANGE:** N/A
- **CONTRACT END DATE CHANGE:** None since contract terms note auto renewal for one-year periods prior to the end of the existing one-year period. A contract extension will be needed at the 1/1/23 timeframe for project completion.
- **ADDITIONAL FUNDING NEEDED:** \$8,000.00
- **BILLING TERMS CHANGE:** An additional billing milestone will be developed in the amount of \$8,000.00 to be billed upon scheduling of the supervisor interviews.
- **Client will provide contract amendment.**

Provided by:

Date:

Vicki Quintero Brashear

9/14/22

Law Offices of Julia Sylva, A Law Corporation
2225 E. 28th Street
Suite 515
Signal Hill, CA 90755



Thank you!

West Valley Water District
855 W. Baseline Road
Rialto, CA 92376

Invoice Date	Invoice Number
09/29/2022	10159
Terms	Service Through
	09/29/2022

*11/13/22
10/13/22
fh*

Total Hours	9.30 hrs
Total Labor	\$ 2,855.00
Total Expenses	\$ 365.00
Total Invoice Amount	\$ 3,220.00
Previous Balance	\$ 0.00
Balance (Amount Due)	\$ 3,220.00

HUNT ORTMANN PALFFY NIEVES
DARLING & MAH, INC.
301 N. LAKE AVE
7TH FLOOR
PASADENA, CA 91101
(626) 440-5200

WEST VALLEY WATER DISTRICT
Attn: Accounts Payable
P.O. BOX 190
RIALTO, CA 92377

October 13, 2022

Account # 7473.002
Invoice # 95789

In Reference to: Contracts

FOR PROFESSIONAL SERVICES RENDERED THROUGH 09/30/2022 SUMMARY OF FEES AND COSTS:

Total Fees:	\$4,818.00
Total Costs:	\$0.00
<u>Total Balance Due</u>	<u>\$4,818.00</u>



**BOARD OF DIRECTORS
STAFF REPORT**

DATE: October 20, 2022
TO: Board of Directors
FROM: Van Jew, Acting General Manager
SUBJECT: AWARD OF CONTRACT FOR THE CONSTRUCTION OF THE OLIVER P. ROEMER WATER FILTRATION FACILITY UPGRADE AND EXPANSION PROJECT

BACKGROUND:

West Valley Water District (“District”) analyzes water demand trends and reviews land use designations for undeveloped parcels within its service area boundary and sphere of influence to determine the future water demands and supply requirements, and to identify the water facilities needed to produce, deliver, store and transport that supply to its customers. The facilities are evaluated based on the projected highest water usage day when the District’s service area is fully developed or built out.

To meet the existing water demands the District utilizes several sources of water supply, including water pumped from four (4) groundwater basins and treated surface water. Local surface water from Lytle Creek and imported State Water Project (“SWP”) water are treated at the Oliver P. Roemer Water Filtration Facility (“Roemer WFF”) and this high-quality drinking water is then delivered to existing customers. The Roemer WFF has a treatment capacity of 14.4 million gallons per day (“mgd”) and is currently operating up to the maximum capacity of the facility.

To provide existing customers with a reliable and drought resistant water supply and to meet rising peak summer demands and projected demands due to infill and growth, the District is implementing the Oliver P. Roemer Water Filtration Facility Upgrade and Expansion Project (Project). The Project will increase treatment capacity at the existing Roemer WFF by 7.2 mgd, for a total treatment capacity of 21.6 mgd and will upgrade critical facility components. The Project will replace aging infrastructure, increase system security, provide operational flexibility, and assist in responsibly managing regional groundwater basins. With the construction of this Project, the District is seeking to implement a conjunctive use strategy which is critical for the long term, sustainable water management for the region.

As part of the expansion, new facilities will be constructed including an influent and effluent pump station, filter and operations building with laboratory/SCADA area, PLC room, kitchen, staff area and education/training space. The new filter building will house three (3) new Trident Filter units with room for future expansion that can be utilized in the interim for storage of portable emergency generators. Upgrades include new ultraviolet disinfection reactors, new granulated activated carbon

influent pumps and electrical/mechanical upgrades of the existing facility that will provide security and reliability enhancements. The westerly side of the Roemer WFF property along Riverside Ave. between Cedar Ave. and Linden Ave. will receive improvements which will showcase drought tolerant landscaping and provide a visually appealing enhancement to the neighborhood and the education/training space would provide the District an area to engage with students and customers through conservation messaging/classes and facilitate tours of the Roemer WFF.

Additional SWP water treated at the Roemer WFF will increase energy generation at the District's Hydro Electric Generation Plant and offset electrical costs associated with the Project, further maximizing the District's investment in both of these facilities.

For this Project, the District is utilizing a Design Build ("DB") delivery method. This procurement method fosters a team environment between the contractors, design team, and the District to consider opportunities to enhance the project to better serve the community further into the design process than in a traditional design-bid-build project. The District solicited proposals from the three (3) firms that were previously vetted through a statement of qualifications process and received those proposals in early June. Proposals were then evaluated by a selection committee and in-person interviews with presentations were undertaken to determine the DB Team to move forward with the District on design and construction of this valuable investment for the community.

GHD, our technical consulting firm that has been assisting the District through the 30% design phase of the project, along with District personnel, comprised the selection committee. Through this process, PCL Construction, Inc. ("PCL") was chosen as the successful DB Team (Attached as Exhibit A is a copy of the proposal received from PCL). To maximize this opportunity, a cooperative effort has been underway between PCL, GHD and the District to refine the project scope. Through this collaboration the collective team has developed a comprehensive guaranteed maximum price that reflects the refined scope of services.

This Project continues to identify new opportunities to serve the community and enhance the operational sustainability and flexibility of the water treatment facility. With the expertise of the DB Team including PCL, GHD and District staff this Project can support the Project mission and the District's vision as well as highlight innovation and environmental stewardship, two of the District's core values, which are at the forefront of this momentous project.

The contracts to be entered into by the District for this project have been prepared, updated and approved by our special legal counsel for this project Hunt Ortmann Palffy Nieves Darling & Mah, Inc. (Attached as Exhibit B is a copy of the Contract Documents)

If approved by the Board of Directors, construction will begin in early 2023 and be completed in early 2025.

FISCAL IMPACT:

Through collaboration among the collective team, a comprehensive guaranteed maximum price was developed that reflects the refined scope of services. The cost to perform the work as proposed by PCL Construction, Inc. is \$59,116,871. This Project is included in the current Capital Improvement Program and is budgeted over multiple fiscal years. Rollover funds and current fiscal year funds total \$31,751,028. The remainder of the funds required for this contract will need to be included in future fiscal year budgets.

The District is near to securing a low interest Drinking Water State Revolving Fund ("SRF") loan

estimated with an interest rate of 1.1%, for the Project and is working with the California State Water Resources Control Board on the final contract language. District staff will continue to pursue additional funding sources to further offset the costs of this project and to look for new opportunities to potentially defray operational costs.

STAFF RECOMMENDATION:

Staff recommends that the Board of Directors to:

1. Award a Design Build contract to PCL Construction, Inc. in the amount of \$59,116,871.00 for the design and construction of the Oliver P. Roemer Upgrade and Expansion Project.
2. Authorize the Acting General Manager to execute the necessary documents.

Respectfully Submitted,

Van Jew

Van Jew, Acting General Manager

LJ:ls

ATTACHMENT(S):

1. EXHIBIT A - PCL Construction Inc. Proposal Revised
2. Exhibit B - Final Contract Documents

MEETING HISTORY:

10/12/22 Engineering, Operations and Planning Committee REFERRED TO BOARD

EXHIBIT A



CONSTRUCTION

IN ASSOCIATION WITH



WEST VALLEY WATER DISTRICT

PROPOSAL FOR THE ROEMER WATER FILTRATION FACILITY DESIGN-BUILD PROJECT

June 3, 2022 | Respondent: PCL Construction, Inc.



TABLE OF CONTENTS

4.2. PART I: TRANSMITTAL LETTER, TEAM ADMINISTRATIVE AND FINANCIAL CAPABILITY	I:1
4.2.1. Transmittal Letter	I:1
4.3. PART II: PROJECT TEAM, EXPERIENCE, AND APPROACH	II:1
• Key Project Personnel	II:1
• DB Project Manager	II:1
• DB Construction Manager	II:1
• Design Manager	II:1
• Key Technical Leads (as needed)	II:1
• Additional Team Members and Experience (Added Since SOQ)	II:3
• Team Experience	II:4
• Project Approach	II:8
• Management of Project Team	II:9
• Project Management Approach	II:11
4.3.1. Environmental Management	II:15
4.3.2. Design Build Quality Control Plan	II:16
• Quality control processes (including for Subconsultants)	II:16
• Document Control	II:17
• Records Management	II:17
• Key staff responsible for quality control and assurance	II:17
• Team Partnership Environment	II:18
4.4. PART III: TECHNICAL APPROACH	III:1
4.4.1. Treatment Processes, Equipment Selection & Capacity	III:1
• History and demonstrated results of the proposed treatment technologies	III:1
• Anticipated useful life of the proposed systems	III:7
• Facility Description	III:7
• In-Plant Pump Station Design	III:10
4.4.2. Hydraulic Capacity	III:12
• Future expansion capacity	III:12
• Minimizing pumping costs	III:12
4.4.3. Non-Process Design and Auxiliary Facilities	III:13
• Construction Sequencing	III:13
• New Filter Building	III:15
• Power Supply & Electrical Equipment	III:17
• Instrumentation & Controls	III:17
4.4.4. Innovation & Design Optimization	III:19

4.5. PART IV: CONSTRUCTION & START-UP PROCESS	IV:1
4.5.1. Construction Planning and Sequencing	IV:1
4.5.2. Approach to Safety	IV:5
• Safety goals, standards, and guidelines	IV:5
• Designation by name of a full-time, on-site safety coordinator who is to be responsible for all safety related activities and a description of other staff positions involved in safety planning and review	IV:5
• A framework for a safety review process and appropriate regular meetings to address safety issues	IV:5
• Documentation of safety procedures	IV:5
• Construction traffic management and equipment and substance (chemicals) safety training	IV:5
• Method for tracking all personnel on Site and controlling Site access	IV:5
4.5.3. Design-Build Schedule	IV:6
4.5.4. Cash Flow	IV:9
4.5.5. Approach to Start-up & testing	IV:10
4.5.6. Acceptance and Training Period Approach	IV:12

**4.6. PART V (PROVIDED SEPARATELY):
FIXED FEE, UNDER A SEPARATE SUBMITTAL**

- 4.6.1. PROPOSAL BID BOND
- 4.7. PART VI: MARKED UP CONTRACT

4.7. PART VI: CONTRACT MARKUP	VI:1
4.8. PART VII: REQUIRED FORMS	VII:1
4.8.1. Forms attached to the RFP	
• Proposal Form 1: Suggested Changes to the Design Build Contract	VII:1
• Proposal Form 3: Bid Bond Form	VII:2
• Proposal Firm 4: Contract Performance Bond Form	VII:7
• Proposal Form 5: Payment Bond Form	VII:10
• Proposal Form 6: Certificate of Acceptance / Waiver of Honorarium	VII:12
• Proposal Form 7: Fixed Fee	Provided Separately
4.8.2. Funding Required Forms	VII:14

- APPENDICES**
- Appendix A: Resumes
 - Appendix B: Site Logistics Plan
 - Appendix C: Schedule
 - Appendix D: Subcontractor & Supplier List
 - Appendix E: Project Specific Safety Plan
 - Appendix F: Start-up & Commissioning | Shutdowns / Tie-Ins
 - Appendix G: Quality Control Plan
 - Appendix H: DBIA 535 & DBIA 545

INDEX

EVALUATION CRITERIA

PART I: TRANSMITTAL LETTER, TEAM ADMINISTRATIVE AND FINANCIAL CAPABILITY	I:1
Transmittal Letter	I:1
Bonding, Sureties, etc.	1:9
Financial Capacity Confirmation	1:9
Project Labor Commitments and CEQA Compliance Confirmation	I:1
PART II: PROJECT TEAM, EXPERIENCE, AND APPROACH	II:1
Project Team / Org Structure	II:2
Key Personnel	II:1
Project Experience	II:4
Project Management Approach	II:19
Coordination and Communication	II:13
Permit Requirements and Updates	II:15
Quality Management Plan	II:16
PART III: TECHNICAL APPROACH	III:1
Treatment Processes, Equipment Selection & Capacity	III:1
Non-Process Design and Auxiliary Facilities	III:1
Innovation & Design Optimization	III:1
PART IV: CONSTRUCTION & START-UP PROCESS	IV:1
Construction Planning and Sequencing	IV:1
Approach to Safety	IV:5
Design-Build Schedule	IV:6
Approach to Start-up & testing	IV:10
Acceptance and Training Period Approach	IV:12
PART V (PROVIDED SEPARATELY): FIXED FEE, UNDER A SEPARATE SUBMITTAL	
Fixed Fee	
Selection and approach to Commodities Escalation	
PART VI: MARKED UP CONTRACT	VI:1
PART VII: REQUIRED FORMS	VII:1

PART I ▶

TRANSMITTAL LETTER, TEAM ADMINISTRATIVE & FINANCIAL CAPABILITY

PART I**TRANSMITTAL LETTER, TEAM ADMINISTRATIVE
AND FINANCIAL CAPABILITY**

▶ TOGETHER WE BUILD SUCCESS

PROPOSAL FORM 2

PROPOSAL TRANSMITTAL LETTER

June 3, 2022

Mrs. Linda Jadeski, Director of Engineering
 West Valley Water District
 855 W. Base Line
 Rialto, CA 92377

Re: Proposal for Oliver P. Roemer Water Filtration Facility 2022 Upgrades and Expansion

PCL Construction, Inc. _____ (the Respondent) hereby submits its Proposal in response to the Request for Proposals for the Oliver P. Roemer Water Filtration Facility 2022 Upgrades and Expansion DB Project (RFP) issued by the West Valley Water District (District) on March 16, 2022, as amended.

As a duly authorized representative of the Respondent, I hereby certify, represent, and warrant as follows in connection with the Proposal:

1. The Respondent acknowledges receipt of the RFP and the following addenda:

No.	Date	No.	Date
<u>1</u>	<u>April 4, 2022</u>	<u>5</u>	<u>May 26, 2022</u>
<u>2</u>	<u>April 25, 2022</u>	<u>6</u>	<u>June 1, 2022</u>
<u>3</u>	<u>May 12, 2022</u>		
<u>4</u>	<u>May 19, 2022</u>		

2. The submittal of the Proposal has been duly authorized by, and in all respects is binding upon, the Respondent. Attachment 1 to this Proposal Form is a Certificate of Authorization which evidences my authority to submit the Proposal and bind the Respondent.
3. All Key Project Team Members identified in our SOQ have not changed. Two Key Project Team Members have new roles to provide greater value to the District. Ken Slota will serve in an Executive Advisory Role to Darren Wright who is now the proposed Design-Build Project Manager. This change was made due to Darren's strong client relationship, large-scale project leadership experience, and proximity to site and owner offices.
4. All Sub-Consultants identified in our SOQ have not changed.

PCL Construction, Inc.
 3750 Schauffele Ave., Suite 270
 Long Beach, CA 90808
 Phone (562) 317-0026 www.pcl.com

TRANSMITTAL LETTER

5. A list of required contractor's and specialty licenses held by Project Team members have not changed.
6. All financial information provided in the SOQ, has not adversely changed.
7. The Proposal contains the requisite Proposal Bid Bond for assuring that the Respondent will enter into the Design-Build Contract if determined to be the Selected Respondent. The Respondent has reviewed and understands the requirements of the RFP and all addenda thereto and, if determined to be the Selected Respondent, agrees to execute the Design-Build Contract.
8. The Respondent's obligations under the Design-Build Contract will be guaranteed absolutely and unconditionally by the following co-sureties, as evidenced by the Certificate of Authorization (see attached): Federal Insurance Company (Lead Co-Surety Partner at ¼ share; Travelers Casualty and Surety Company of America; Berkshire Hathaway Specialty Insurance Company; Liberty Mutual Insurance Company
9. The Required Design/Build Period Insurance required by the Design-Build Contract will be provided or brokered by Aon Reed Stenhouse, Inc. & Marsh USA, Inc.
10. All information and statements contained in the Proposal are current, correct and complete, and are made with full knowledge that the District will rely on such information and statements in selecting the Selected Respondent and executing the Design-Build Contract.
11. The Proposal has been prepared and is submitted without collusion, fraud or any other action taken in restraint of free and open competition for the services contemplated by the RFP.
12. Neither the Respondent, the Guarantor nor any Project Team Member is currently suspended or debarred from doing business with any governmental entity.
13. The Respondent has reviewed all of the engagements and pending engagements of the Respondent and the Guarantor, and no potential exists for any conflict of interest or unfair advantage.
14. No person or selling agency has been employed or retained to solicit the award of the Design-Build Contract under an arrangement for a commission, percentage, brokerage or contingency fee or on any other success fee basis, except bona fide employees of the Respondent or the Guarantor.
15. The District has signed a Community Workforce Agreement which is included as part of the Design-Build Contract. The DB Teams, including subcontractors, agrees to adhere to the requirements of the CWA.

TRANSMITTAL LETTER

16. The District has completed CEQA Compliance, which the DB Teams, including subcontractors, agrees to adhere and administer as necessary.

17. The principal contact person who will serve as the interface between the District and the Respondent for all communications is:

NAME: Darren Wright

TITLE: Design-Build Project Manager

ADDRESS: 3750 Schauffele Ave., Suite 270, Long Beach, CA 90808

PHONE: 562-233-6723

E-MAIL: dmwright@pcl.com

18. The key technical and legal representatives available to provide timely response to written inquiries submitted, and to attend meetings requested by the District are:

Technical Representative:

NAME: Sean Neprud, Stantec

TITLE: Design Manager

ADDRESS: 300 North Lake Avenue Suite 400, Pasadena CA 91101

PHONE: 626-568-6040

E-MAIL: Sean.Neprud@stantec.com

Legal Representative:

NAME: Ankur Talwar, PCL Construction

TITLE: Area Manager

ADDRESS: 3750 Schauffele Ave., Suite 270, Long Beach, CA 90808

PHONE: 562-480-1215

E-MAIL: artalwar@pcl.com

19. The Respondent has carefully examined all documents constituting the RFP and the addenda thereto and, being familiar with the work and the conditions affecting the work contemplated by the RFP and such addenda, offers to furnish all plant, labor, materials, supplies, equipment, facilities and services which are necessary, proper or incidental to carry out such work as required by and in strict accordance with the RFP and the Proposal, all for the prices set forth in the Proposal Forms.

TRANSMITTAL LETTER

Name of Respondent PCL Construction, Inc.
 Name of Designated Signatory Ankur Talwar
 Signature *Ankur Talwar*
 Title Area Manager
 (Notary Public) _____

State of Arizona
 County of Maricopa

On this 06-03 day of, 2022, before me appeared, Ankur Talwar, personally known to me to be the person described in and who executed this proposal and acknowledged that (she/he) signed the same freely and voluntarily for the uses and purposes therein described.

In witness thereof, I have hereunto set my hand and affixed by official seal the day and year last written above.

[Signature]

Notary Public in and for the State of Arizona

Robin R Adams

(Name printed)

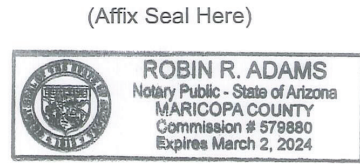

Residing at 1711 W Greentree Dr #201 Tempe AZ 85284

My commission expires March 2, 2024

CERTIFICATE OF AUTHORITY

No. 6516

STATE OF CALIFORNIA
DEPARTMENT OF INSURANCE
 SAN FRANCISCO

Amended
Certificate of Authority

THIS IS TO CERTIFY that, pursuant to the Insurance Code of the State of California,

Travelers Casualty and Surety Company of America

of Hartford, Connecticut, organized under the laws of Connecticut, subject to its Articles of Incorporation or other fundamental organizational documents, is hereby authorized to transact within this State, subject to all provisions of this Certificate, the following classes of insurance:

**Fire, Marine, Surety, Disability, Plate Glass, Liability, Workers' Compensation,
 Common Carrier Liability, Boiler and Machinery, Burglary, Credit, Sprinkler,
 Team and Vehicle, Automobile, Aircraft and Miscellaneous**

as such classes are now or may hereafter be defined in the Insurance Laws of the State of California.

THIS CERTIFICATE is expressly conditioned upon the holder hereof now and hereafter being in full compliance with all, and not in violation of any, of the applicable laws and lawful requirements made under authority of the laws of the State of California as long as such laws or requirements are in effect and applicable, and as such laws and requirements now are, or may hereafter be changed or amended.

IN WITNESS WHEREOF, effective as of the 1st day of July, 1997,
 I have hereunto set my hand and caused my official seal to be affixed
 this 16th day of June, 1997.

Fee: \$ 92.00
 Rec. No.
 Filed: 5/28/97

Chuck Quackenbush
 Insurance Commissioner

By

Victoria S. Sidbury
 Deputy

Certification

I, the undersigned Insurance Commissioner of the State of California, do hereby certify that I have compared the above copy of Certificate of Authority with the duplicate of original now on file in my office, and that the same is a full, true, and correct transcript thereof, and of the whole of said duplicate, and said Certificate of Authority is now in full force and effect.

IN WITNESS WHEREOF, I have set my hand and caused my official seal to be affixed this 29th day of September, 2020.

Ricardo Lara
 Insurance Commissioner

By

Magnolia utierrez

CERTIFICATE OF AUTHORITY

Nº 5389

STATE OF CALIFORNIA
DEPARTMENT OF INSURANCE
SAN FRANCISCO

AMENDED

Certificate of Authority

THIS IS TO CERTIFY, That, pursuant to the Insurance Code of the State of California,
Federal Insurance Company

of Indianapolis, Indiana, organized under the laws of Indiana, subject to its Articles of Incorporation or other fundamental organizational documents, is hereby authorized to transact within this State, subject to all provisions of this Certificate, the following classes of insurance: FIRE, MARINE, SURETY, DISABILITY, PLATE GLASS, LIABILITY, WORKERS' COMPENSATION, COMMON CARRIER LIABILITY, BOILER AND MACHINERY, BURGLARY, CREDIT, SPRINKLER, TEAM AND VEHICLE, AUTOMOBILE, AIRCRAFT and MISCELLANEOUS as such classes are now or may hereafter be defined in the Insurance Laws of the State of California.

THIS CERTIFICATE is expressly conditioned upon the holder hereof now and hereafter being in full compliance with all, and not in violation of any, of the applicable laws and lawful requirements made under authority of the laws of the State of California as long as such laws or requirements are in effect and applicable, and as such laws and requirements now are, or may hereafter be changed or amended.

IN WITNESS WHEREOF, effective as of the 15th day of October, 1990, I have hereunto set my hand and caused my official seal to be affixed this 15th day of October, 1990.

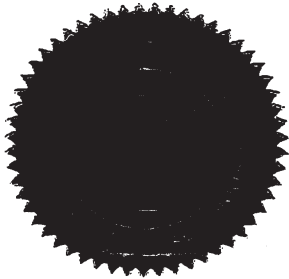

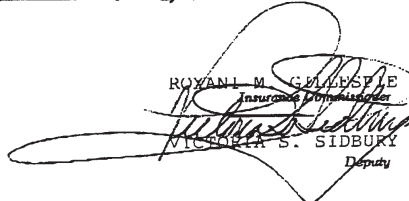
By 
ROYANI M. GLEDHILL
Insurance Commissioner
MICHAEL S. SIDBURY
Deputy

NOTICE:
Qualification with the Secretary of State must be accomplished as required by the California Corporations Code promptly after issuance of this Certificate of Authority. Failure to do so will be a violation of Ins. Code Sec. 701 and will be grounds for revoking this Certificate of Authority pursuant to the covenants made in the application therefor and the conditions contained herein.

FORM CB-3

02 84051

CERTIFICATE OF AUTHORITY

Nº 2131

STATE OF CALIFORNIA
DEPARTMENT OF INSURANCE
SAN FRANCISCO

AMENDED

Certificate of Authority

THIS IS TO CERTIFY, That, pursuant to the Insurance Code of the State of California,

LIBERTY MUTUAL INSURANCE COMPANY

of BOSTON, MASSACHUSETTS, organized under the laws of MASSACHUSETTS, subject to its Articles of Incorporation or other fundamental organizational documents, is hereby authorized to transact within this State, subject to all provisions of this Certificate, the following classes of insurance: FIRE, MARINE, SURETY, DISABILITY, PLATE GLASS, LIABILITY, WORKMEN'S COMPENSATION, COMMON CARRIER LIABILITY, BOILER AND MACHINERY, BURGLARY, CREDIT, SPRINKLER, TEAM AND VEHICLE, AUTOMOBILE, AIRCRAFT and MISCELLANEOUS

as such classes are now or may hereafter be defined in the Insurance Laws of the State of California.

THIS CERTIFICATE is expressly conditioned upon the holder hereof now and hereafter being in full compliance with all, and not in violation of any, of the applicable laws and lawful requirements made under authority of the laws of the State of California as long as such laws or requirements are in effect and applicable, and as such laws and requirements now are, or may hereafter be changed or amended.

IN WITNESS WHEREOF, effective as of the 15TH day of NOVEMBER, 1961, I have hereunto set my hand and caused my official seal to be affixed this 15TH day of NOVEMBER, 1961.



F. BRITTON McCONNELL
Insurance Commissioner

By *John H. Andrews*
Deputy

1112 1-66 800 D19 870

ATTACHMENT 1 TO PROPOSAL FORM 2: CERTIFICATE OF AUTHORIZATION

Attachment 1 to Proposal Form 2

CERTIFICATE OF AUTHORIZATION ⁽¹⁾

I, Shawn Britton, a resident of Chandler in the State of Arizona
 _____, DO HEREBY CERTIFY that I am the Clerk/Secretary of PCL Construction, Inc., a corporation
 duly organized and existing under and by virtue of the laws of Colorado; that I have
 custody of the records of the corporation; and that as of the date of this certification, Ankur Talwar
 holds the title of the corporation, and is authorized to execute and deliver in the name and on behalf of the corporation
 the Proposal submitted by the corporation in response to the Request for Proposals for West Valley Water District –
 Oliver P. Roemer Water Filtration Facility DB Project June 3, 2022, as amended; and all documents,
 letters, certificates and other instruments which have been executed by such officer on behalf of the corporation in
 connection therewith.

IN WITNESS WHEREOF, I have hereunto set my hand and affixed the corporate seal of the corporation this day of
JUNE 1 2022.

(Affix Seal Here)



 Shawn W. Britton
 Secretary / Treasurer
 Clerk/Secretary

1. Separate certifications shall be submitted if more than one corporate officer has executed documents as part of the Proposal. Respondents shall make appropriate conforming modifications to this Certificate in the event that the signatory's address is outside of the United States.

FINANCIAL CAPABILITY - BONDING, SURETIES

CHUBB
 FEDERAL INSURANCE COMPANY
 PACIFIC INDEMNITY COMPANY
 VIGILANT INSURANCE COMPANY

Surety
 202B Halls Mill Road, PO Box 1650
 Whitehouse Station, NJ 08889-1650
 O + 908.903.3485
 F + 908.903.3656

April 14, 2022

West Valley Water District
 855 W Baseline Rd
 Rialto, California 92376

**RE: PCL Construction, Inc. – Surety Letter of Intent
 Design-Build Services for the Oliver P. Roemer Water Filtration Facility 2022 Upgrades and Expansion
 Request For Proposal, Estimated Contract Value: \$40,000,000+**

To Whom It May Concern:

Federal Insurance Company, a Chubb Insurance Company, as lead surety, along with Travelers Casualty and Surety Company of America, Berkshire Hathaway Specialty Insurance Company, and Liberty Mutual Insurance Company wish to advise that we collectively act as joint and several co-sureties on behalf of the *PCL* family of companies, which includes *PCL Construction, Inc.*

As sureties, we are among the major providers of contract surety bonds across the U.S., are each licensed to transact business in all U.S. States, and are each listed in the U.S. Department of Treasury's Circular 570 as acceptable sureties. Federal Insurance Company (Chubb) currently have an AM Best Rating of A++ XV and an S&P Rating of AA. Travelers Casualty and Surety Company of America currently has an AM Best Rating of A++ XV and an S&P Rating of AA. Berkshire Hathaway Specialty Insurance Company currently has an AM Best Rating of A++ XV and an S&P Rating of AA+. Liberty Mutual Insurance Company currently has an AM Best Rating of A XV and an S&P Rating of A.

We hereby confirm that we intend to issue a Performance Bond (Proposal Form 4) and Payment Bond (Proposal Form 5) to PCL Construction, Inc. as Principal, with regard to the subject Project should our valued client be awarded the project.

We understand that the prime contract will be in the form of a Design Build Agreement. The Performance Bond and Payment Bond will be for One Hundred Percent (100%) of the amount equal to the total Fixed Price of the Design-Build Agreement.

By executing this letter, we as co-sureties acknowledge that we have reviewed the information in this letter and in the RFP and should PCL Construction, Inc. be awarded the project, we will deliver the Payment and Performance Bonds subject to ours and PCL's review and acceptance of the Design Build Agreement documents, and full project financing being in place.

Sincerely,
 FEDERAL INSURANCE COMPANY
 TRAVELERS CASUALTY AND SURETY COMPANY OF AMERICA
 BERKSHIRE HATHAWAY SPECIALTY INSURANCE COMPANY
 LIBERTY MUTUAL INSURANCE COMPANY

By: 
 Susan A. Welsh, Attorney-in-Fact

FINANCIAL CAPABILITY - BONDING, SURETIES

CALIFORNIA ALL-PURPOSE ACKNOWLEDGMENT

A Notary Public or other officer completing this certificate verifies only the identity of the individual who signed the document to which this certificate is attached, and not the truthfulness, accuracy, or validity of that document.

State of Illinois

County of Cook

On 14th day of April, 2022, before me, Sandra M. Winsted, Notary Public, personally appeared Susan A. Welsh who proved to me on the basis of satisfactory evidence to be the person(s) whose name(s) is/are subscribed to the within instrument and acknowledged to me that he/she/they executed the same in his/her/their authorized capacity(ies), and that by his/her/their signature(s) on the instrument the person(s), or the entity upon behalf of which the person(s) acted, executed the instrument.

I certify under PENALTY OF PERJURY under the laws of the State of California that the foregoing paragraph is true and correct.

WITNESS my hand and official seal.

Signature

Signature of Notary Public



FINANCIAL CAPABILITY - BONDING, SURETIES



Power of Attorney

Federal Insurance Company | Vigilant Insurance Company | Pacific Indemnity Company
Westchester Fire Insurance Company | ACE American Insurance Company

Know All by These Presents, that **FEDERAL INSURANCE COMPANY**, an Indiana corporation, **VIGILANT INSURANCE COMPANY**, a New York corporation, **PACIFIC INDEMNITY COMPANY**, a Wisconsin corporation, **WESTCHESTER FIRE INSURANCE COMPANY** and **ACE AMERICAN INSURANCE COMPANY** corporations of the Commonwealth of Pennsylvania, do each hereby constitute and appoint Corinne Chapman, Samantha Chierici, Jessica B. Dempsey, Derek J. Elston, Rachel Fore, Kristin L Hannigan, Jennifer L. Jakaitis, Nicholas Kertesz, Judith A. Lucky-Eftimov, James B. McTaggart, Christopher T. Moser, Sandra M. Nowak, Diane M. O'Leary, Nicholas Pantazis, Roger Paraison, Christina L. Sandoval, Bartlomiej Siepierski, Jean Torres, Christopher P. Troha, Aerie Walton, Susan A. Welsh and Sandra M. Winsted of Chicago, Illinois-----

each as their true and lawful Attorney-in-Fact to execute under such designation in their names and to affix their corporate seals to and deliver for and on their behalf as surety thereon or otherwise, bonds and undertakings and other writings obligatory in the nature thereof (other than bail bonds) given or executed in the course of business, and any instruments amending or altering the same, and consents to the modification or alteration of any instrument referred to in said bonds or obligations.

In Witness Whereof, said **FEDERAL INSURANCE COMPANY**, **VIGILANT INSURANCE COMPANY**, **PACIFIC INDEMNITY COMPANY**, **WESTCHESTER FIRE INSURANCE COMPANY** and **ACE AMERICAN INSURANCE COMPANY** have each executed and attested these presents and affixed their corporate seals on this 19th day of **January, 2022**.

Dawn M. Chloros

Dawn M. Chloros, Assistant Secretary

Stephen M. Haney

Stephen M. Haney, Vice President



STATE OF NEW JERSEY
County of Hunterdon

ss.

On this 19th day of **January, 2022** before me, a Notary Public of New Jersey, personally came Dawn M. Chloros and Stephen M. Haney, to me known to be Assistant Secretary and Vice President, respectively, of **FEDERAL INSURANCE COMPANY**, **VIGILANT INSURANCE COMPANY**, **PACIFIC INDEMNITY COMPANY**, **WESTCHESTER FIRE INSURANCE COMPANY** and **ACE AMERICAN INSURANCE COMPANY**, the companies which executed the foregoing Power of Attorney, and the said Dawn M. Chloros and Stephen M. Haney, being by me duly sworn, severally and each for herself and himself did depose and say that they are Assistant Secretary and Vice President, respectively, of **FEDERAL INSURANCE COMPANY**, **VIGILANT INSURANCE COMPANY**, **PACIFIC INDEMNITY COMPANY**, **WESTCHESTER FIRE INSURANCE COMPANY** and **ACE AMERICAN INSURANCE COMPANY** and know the corporate seals thereof, that the seals affixed to the foregoing Power of Attorney are such corporate seals and were thereto affixed by authority of said Companies; and that their signatures as such officers were duly affixed and subscribed by like authority.

Notarial Seal



KATHERINE J. ADELAAR
NOTARY PUBLIC OF NEW JERSEY
No. 2316685
Commission Expires July 16, 2024

Katherine J. Adelaar
Notary Public

CERTIFICATION

Resolutions adopted by the Boards of Directors of **FEDERAL INSURANCE COMPANY**, **VIGILANT INSURANCE COMPANY**, and **PACIFIC INDEMNITY COMPANY** on August 30, 2016; **WESTCHESTER FIRE INSURANCE COMPANY** on December 11, 2006; and **ACE AMERICAN INSURANCE COMPANY** on March 20, 2009:

"RESOLVED, that the following authorizations relate to the execution, for and on behalf of the Company, of bonds, undertakings, recognizances, contracts and other written commitments of the Company entered into in the ordinary course of business (each a "Written Commitment"):

- (1) Each of the Chairman, the President and the Vice Presidents of the Company is hereby authorized to execute any Written Commitment for and on behalf of the Company, under the seal of the Company or otherwise.
- (2) Each duly appointed attorney-in-fact of the Company is hereby authorized to execute any Written Commitment for and on behalf of the Company, under the seal of the Company or otherwise, to the extent that such action is authorized by the grant of powers provided for in such person's written appointment as such attorney-in-fact.
- (3) Each of the Chairman, the President and the Vice Presidents of the Company is hereby authorized, for and on behalf of the Company, to appoint in writing any person the attorney-in-fact of the Company with full power and authority to execute, for and on behalf of the Company, under the seal of the Company or otherwise, such Written Commitments of the Company as may be specified in such written appointment, which specification may be by general type or class of Written Commitments or by specification of one or more particular Written Commitments.
- (4) Each of the Chairman, the President and the Vice Presidents of the Company is hereby authorized, for and on behalf of the Company, to delegate in writing to any other officer of the Company the authority to execute, for and on behalf of the Company, under the Company's seal or otherwise, such Written Commitments of the Company as are specified in such written delegation, which specification may be by general type or class of Written Commitments or by specification of one or more particular Written Commitments.
- (5) The signature of any officer or other person executing any Written Commitment or appointment or delegation pursuant to this Resolution, and the seal of the Company, may be affixed by facsimile on such Written Commitment or written appointment or delegation.

FURTHER RESOLVED, that the foregoing Resolution shall not be deemed to be an exclusive statement of the powers and authority of officers, employees and other persons to act for and on behalf of the Company, and such Resolution shall not limit or otherwise affect the exercise of any such power or authority otherwise validly granted or vested."

I, Dawn M. Chloros, Assistant Secretary of **FEDERAL INSURANCE COMPANY**, **VIGILANT INSURANCE COMPANY**, **PACIFIC INDEMNITY COMPANY**, **WESTCHESTER FIRE INSURANCE COMPANY** and **ACE AMERICAN INSURANCE COMPANY** (the "Companies") do hereby certify that

- (i) the foregoing Resolutions adopted by the Board of Directors of the Companies are true, correct and in full force and effect,
- (ii) the foregoing Power of Attorney is true, correct and in full force and effect.

Given under my hand and seals of said Companies at Whitehouse Station, NJ, this *4/14/2022*



Dawn M. Chloros

Dawn M. Chloros, Assistant Secretary

IN THE EVENT YOU WISH TO VERIFY THE AUTHENTICITY OF THIS BOND OR NOTIFY US OF ANY OTHER MATTER, PLEASE CONTACT US AT:
Telephone (908) 903-3493 Fax (908) 903-3656 e-mail: surety@chubb.com

FINANCIAL CAPABILITY - BONDING, SURETIES

	Travelers Casualty and Surety Company of America Travelers Casualty and Surety Company St. Paul Fire and Marine Insurance Company
---	--

POWER OF ATTORNEY

KNOW ALL MEN BY THESE PRESENTS: That Travelers Casualty and Surety Company of America, Travelers Casualty and Surety Company, and St. Paul Fire and Marine Insurance Company are corporations duly organized under the laws of the State of Connecticut (herein collectively called the "Companies"), and that the Companies do hereby make, constitute and appoint **Susan A. Welsh** of **CHICAGO Illinois**, their true and lawful Attorney(s)-in-Fact to sign, execute, seal and acknowledge any and all bonds, recognizances, conditional undertakings and other writings obligatory in the nature thereof on behalf of the Companies in their business of guaranteeing the fidelity of persons, guaranteeing the performance of contracts and executing or guaranteeing bonds and undertakings required or permitted in any actions or proceedings allowed by law.

IN WITNESS WHEREOF, the Companies have caused this instrument to be signed, and their corporate seals to be hereto affixed, this **21st** day of **April**, 2021.



State of Connecticut

City of Hartford ss.

By: 
 Robert L. Raney, Senior Vice President

On this the **21st** day of **April**, **2021**, before me personally appeared **Robert L. Raney**, who acknowledged himself to be the Senior Vice President of each of the Companies, and that he, as such, being authorized so to do, executed the foregoing instrument for the purposes therein contained by signing on behalf of said Companies by himself as a duly authorized officer.

IN WITNESS WHEREOF, I hereunto set my hand and official seal.

My Commission expires the **30th** day of **June**, **2026**



 Anna P. Nowik, Notary Public

This Power of Attorney is granted under and by the authority of the following resolutions adopted by the Boards of Directors of each of the Companies, which resolutions are now in full force and effect, reading as follows:

RESOLVED, that the Chairman, the President, any Vice Chairman, any Executive Vice President, any Senior Vice President, any Vice President, any Second Vice President, the Treasurer, any Assistant Treasurer, the Corporate Secretary or any Assistant Secretary may appoint Attorneys-in-Fact and Agents to act for and on behalf of the Company and may give such appointee such authority as his or her certificate of authority may prescribe to sign with the Company's name and seal with the Company's seal bonds, recognizances, contracts of indemnity, and other writings obligatory in the nature of a bond, recognizance, or conditional undertaking, and any of said officers or the Board of Directors at any time may remove any such appointee and revoke the power given him or her; and it is

FURTHER RESOLVED, that the Chairman, the President, any Vice Chairman, any Executive Vice President, any Senior Vice President or any Vice President may delegate all or any part of the foregoing authority to one or more officers or employees of this Company, provided that each such delegation is in writing and a copy thereof is filed in the office of the Secretary; and it is

FURTHER RESOLVED, that any bond, recognizance, contract of indemnity, or writing obligatory in the nature of a bond, recognizance, or conditional undertaking shall be valid and binding upon the Company when (a) signed by the President, any Vice Chairman, any Executive Vice President, any Senior Vice President or any Vice President, any Second Vice President, the Treasurer, any Assistant Treasurer, the Corporate Secretary or any Assistant Secretary and duly attested and sealed with the Company's seal by a Secretary or Assistant Secretary; or (b) duly executed (under seal, if required) by one or more Attorneys-in-Fact and Agents pursuant to the power prescribed in his or her certificate or their certificates of authority or by one or more Company officers pursuant to a written delegation of authority; and it is

FURTHER RESOLVED, that the signature of each of the following officers: President, any Executive Vice President, any Senior Vice President, any Vice President, any Assistant Vice President, any Secretary, any Assistant Secretary, and the seal of the Company may be affixed by facsimile to any Power of Attorney or to any certificate relating thereto appointing Resident Vice Presidents, Resident Assistant Secretaries or Attorneys-in-Fact for purposes only of executing and attesting bonds and undertakings and other writings obligatory in the nature thereof, and any such Power of Attorney or certificate bearing such facsimile signature or facsimile seal shall be valid and binding upon the Company and any such power so executed and certified by such facsimile signature and facsimile seal shall be valid and binding on the Company in the future with respect to any bond or understanding to which it is attached.

I, **Kevin E. Hughes**, the undersigned, Assistant Secretary of each of the Companies, do hereby certify that the above and foregoing is a true and correct copy of the Power of Attorney executed by said Companies, which remains in full force and effect.

Dated this 14 day of April, 2022



 Kevin E. Hughes, Assistant Secretary

To verify the authenticity of this Power of Attorney, please call us at 1-800-421-3880.
Please refer to the above-named Attorney(s)-in-Fact and the details of the bond to which this Power of Attorney is attached.

FINANCIAL CAPABILITY - BONDING, SURETIES



26704

Power Of Attorney

BERKSHIRE HATHAWAY SPECIALTY INSURANCE COMPANY NATIONAL INDEMNITY COMPANY / NATIONAL LIABILITY & FIRE INSURANCE COMPANY

Know all men by these presents, that **BERKSHIRE HATHAWAY SPECIALTY INSURANCE COMPANY**, a corporation existing under and by virtue of the laws of the State of Nebraska and having an office at One Lincoln Street, 23rd Floor, Boston, Massachusetts 02111, **NATIONAL INDEMNITY COMPANY**, a corporation existing under and by virtue of the laws of the State of Nebraska and having an office at 3024 Harney Street, Omaha, Nebraska 68131 and **NATIONAL LIABILITY & FIRE INSURANCE COMPANY**, a corporation existing under and by virtue of the laws of the State of Connecticut and having an office at 100 First Stamford Place, Stamford, Connecticut 06902 (hereinafter collectively the "Companies"), pursuant to and by the authority granted as set forth herein, do hereby name, constitute and appoint: **Sandra M. Winsted, Susan A. Welsh, Derek J. Elston, Sandra M. Nowak, Christopher P. Troha, Jessica B. Dempsey, Judith A. Lucky-Eftimov, Christina L. Sandoval, Aerie Walton, Bartłomiej Siepierski, Rachel Fore, Samantha Chierici, Corinne Chapman, Roger Paraison, Kristin L. Hannigan, Jean Torres, Nicholas Kertesz, Christopher T. Moser, 200 East Randolph St, Aon Center of the city of Chicago, State of Illinois**, their true and lawful attorney(s)-in-fact to make, execute, seal, acknowledge, and deliver, for and on their behalf as surety and as their act and deed, any and all undertakings, bonds, or other such writings obligatory in the nature thereof, in pursuance of these presents, the execution of which shall be as binding upon the Companies as if it has been duly signed and executed by their regularly elected officers in their own proper persons. This authority for the Attorney-in-Fact shall be limited to the execution of the attached bond(s) or other such writings obligatory in the nature thereof.

In witness whereof, this Power of Attorney has been subscribed by an authorized officer of the Companies, and the corporate seals of the Companies have been affixed hereto this date of December 20, 2018. This Power of Attorney is made and executed pursuant to and by authority of the Bylaws, Resolutions of the Board of Directors, and other Authorizations of **BERKSHIRE HATHAWAY SPECIALTY INSURANCE COMPANY, NATIONAL INDEMNITY COMPANY** and **NATIONAL LIABILITY & FIRE INSURANCE COMPANY**, which are in full force and effect, each reading as appears on the back page of this Power of Attorney, respectively. The following signature by an authorized officer of the Company may be a facsimile, which shall be deemed the equivalent of and constitute the written signature of such officer of the Company for all purposes regarding this Power of Attorney, including satisfaction of any signature requirements on any and all undertakings, bonds, or other such writings obligatory in the nature thereof, to which this Power of Attorney applies.

BERKSHIRE HATHAWAY SPECIALTY INSURANCE COMPANY,

By: David Fields, Executive Vice President



NATIONAL INDEMNITY COMPANY, NATIONAL LIABILITY & FIRE INSURANCE COMPANY,

By: David Fields, Vice President



NOTARY

State of Massachusetts, County of Suffolk, ss:

On this 20th day of December, 2018, before me appeared David Fields, Executive Vice President of **BERKSHIRE HATHAWAY SPECIALTY INSURANCE COMPANY** and Vice President of **NATIONAL INDEMNITY COMPANY** and **NATIONAL LIABILITY & FIRE INSURANCE COMPANY**, who being duly sworn, says that his capacity is as designated above for such Companies; that he knows the corporate seals of the Companies; that the seals affixed to the foregoing instrument are such corporate seals; that they were affixed by order of the board of directors or other governing body of said Companies pursuant to its Bylaws, Resolutions and other Authorizations, and that he signed said instrument in that capacity of said Companies.

[Notary Seal]

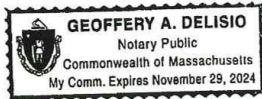

Notary Public

I, Ralph Tortorella, the undersigned, Officer of **BERKSHIRE HATHAWAY SPECIALTY INSURANCE COMPANY, NATIONAL INDEMNITY COMPANY** and **NATIONAL LIABILITY & FIRE INSURANCE COMPANY**, do hereby certify that the above and foregoing is a true and correct copy of the Power of Attorney executed by said Companies which is in full force and effect and has not been revoked. IN TESTIMONY WHEREOF, see hereunto affixed the seals of said Companies this April 14, 2022.



Officer

BHSIC, NICO & NLF POA (2018)

To verify the authenticity of this Power of Attorney please contact us at: BHSI Surety Department, Berkshire Hathaway Specialty Insurance Company, One Lincoln Street, 23rd Floor Boston, MA 02111 | (770) 625-2516 or by email at Jennifer.Porter@bhspecialty.com. THIS POWER OF ATTORNEY IS VOID IF ALTERED. To notify us of a claim please contact us on our 24-hour toll free number at (855) 453-5675, via email at claimsnotice@bhspecialty.com, via fax to (617) 507-8259, or via mail.

FINANCIAL CAPABILITY - BONDING, SURETIES

BERKSHIRE HATHAWAY SPECIALTY INSURANCE COMPANY (BYLAWS)

ARTICLE V.

CORPORATE ACTIONS

....

EXECUTION OF DOCUMENTS:

....

Section 6.(b) The President, any Vice President or the Secretary, shall have the power and authority:

- (1) To appoint Attorneys-in-fact, and to authorize them to execute on behalf of the Company bonds and other undertakings, and
- (2) To remove at any time any such Attorney-in-fact and revoke the authority given him.

NATIONAL INDEMNITY COMPANY (BY-LAWS)

Section 4. Officers, Agents, and Employees:

A. The officers shall be a President, one or more Vice Presidents, a Secretary, one or more Assistant Secretaries, a Treasurer, and one or more Assistant Treasurers none of whom shall be required to be shareholders or Directors and each of whom shall be elected annually by the Board of Directors at each annual meeting to serve a term of office of one year or until a successor has been elected and qualified, may serve successive terms of office, may be removed from office at any time for or without cause by a vote of a majority of the Board of Directors, and shall have such powers and rights and be charged with such duties and obligations as usually are vested in and pertain to such office or as may be directed from time to time by the Board of Directors; and the Board of Directors or the officers may from time to time appoint, discharge, engage, or remove such agents and employees as may be appropriate, convenient, or necessary to the affairs and business of the corporation.

NATIONAL INDEMNITY COMPANY (BOARD RESOLUTION ADOPTED AUGUST 6, 2014)

RESOLVED, That the President, any Vice President or the Secretary, shall have the power and authority to (1) appoint Attorneys-in-fact, and to authorize them to execute on behalf of this Company bonds and other undertakings and (2) remove at any time any such Attorney-in-fact and revoke the authority given.

NATIONAL LIABILITY & FIRE INSURANCE COMPANY (BY-LAWS)

ARTICLE IV

Officers

Section 1. Officers, Agents and Employees:

A. The officers shall be a president, one or more vice presidents, one or more assistant vice presidents, a secretary, one or more assistant secretaries, a treasurer, and one or more assistant treasurers, none of whom shall be required to be shareholders or directors, and each of whom shall be elected annually by the board of directors at each annual meeting to serve a term of office of one year or until a successor has been elected and qualified, may serve successive terms of office, may be removed from office at any time for or without cause by a vote of a majority of the board of directors. The president and secretary shall be different individuals. Election or appointment of an officer or agent shall not create contract rights. The officers of the Corporation shall have such powers and rights and be charged with such duties and obligations as usually are vested in and pertain to such office or as may be directed from time to time by the board of directors; and the board of directors or the officers may from time to time appoint, discharge, engage, or remove such agents and employees as may be appropriate, convenient, or necessary to the affairs and business of the Corporation.

NATIONAL LIABILITY & FIRE INSURANCE COMPANY (BOARD RESOLUTION ADOPTED AUGUST 6, 2014)

RESOLVED, That the President, any Vice President or the Secretary, shall have the power and authority to (1) appoint Attorneys-in-fact, and to authorize them to execute on behalf of this Company bonds and other undertakings and (2) remove at any time any such Attorney-in-fact and revoke the authority given.

BHSIC, NICO & NLF POA (2018)

FINANCIAL CAPABILITY - BONDING, SURETIES



This Power of Attorney limits the acts of those named herein, and they have no authority to bind the Company except in the manner and to the extent herein stated.

Liberty Mutual Insurance Company
The Ohio Casualty Insurance Company
West American Insurance Company

Certificate No: 8207154 - 285057

POWER OF ATTORNEY

KNOWN ALL PERSONS BY THESE PRESENTS: That The Ohio Casualty Insurance Company is a corporation duly organized under the laws of the State of New Hampshire, that Liberty Mutual Insurance Company is a corporation duly organized under the laws of the State of Massachusetts, and West American Insurance Company is a corporation duly organized under the laws of the State of Indiana (herein collectively called the "Companies"), pursuant to and by authority herein set forth, does hereby name, constitute and appoint, Christina L. Sandoval; Christopher T. Moser; Corinne Chapman; Diane M. O'Leary; James B. McTaggart; Jean Torres; Jennifer L. Jakaitis; Jessica B Dempsey; Judith A. Lucky-Efimov; Kristin L. Hannigan; Nicholas Kertesz; Roger Paraison; Samantha Chierici; Sandra M. Nowak; Sandra M. Winsted; Susan A. Welsh

all of the city of Chicago state of IL each individually if there be more than one named, its true and lawful attorney-in-fact to make, execute, seal, acknowledge and deliver, for and on its behalf as surety and as its act and deed, any and all undertakings, bonds, recognizances and other surety obligations, in pursuance of these presents and shall be as binding upon the Companies as if they have been duly signed by the president and attested by the secretary of the Companies in their own proper persons.

IN WITNESS WHEREOF, this Power of Attorney has been subscribed by an authorized officer or official of the Companies and the corporate seals of the Companies have been affixed thereto this 20th day of January, 2022.



Liberty Mutual Insurance Company
The Ohio Casualty Insurance Company
West American Insurance Company

By: David M. Carey
David M. Carey, Assistant Secretary

Not valid for mortgage, note, loan, letter of credit, currency rate, interest rate or residual value guarantees.

For bond and/or Power of Attorney (POA) verification inquiries, please call 610-832-8240 or email HOSUR@libertymutual.com.

State of PENNSYLVANIA ss
County of MONTGOMERY

On this 20th day of January, 2022 before me personally appeared David M. Carey, who acknowledged himself to be the Assistant Secretary of Liberty Mutual Insurance Company, The Ohio Casualty Company, and West American Insurance Company, and that he, as such, being authorized so to do, execute the foregoing instrument for the purposes therein contained by signing on behalf of the corporations by himself as a duly authorized officer.

IN WITNESS WHEREOF, I have hereunto subscribed my name and affixed my notarial seal at King of Prussia, Pennsylvania, on the day and year first above written.



Commonwealth of Pennsylvania - Notary Seal
Teresa Pastella, Notary Public
Montgomery County
My commission expires March 28, 2025
Commission number 1126044
Member, Pennsylvania Association of Notaries

By: Teresa Pastella
Teresa Pastella, Notary Public

This Power of Attorney is made and executed pursuant to and by authority of the following By-laws and Authorizations of The Ohio Casualty Insurance Company, Liberty Mutual Insurance Company, and West American Insurance Company which resolutions are now in full force and effect reading as follows:

ARTICLE IV – OFFICERS: Section 12. Power of Attorney.

Any officer or other official of the Corporation authorized for that purpose in writing by the Chairman or the President, and subject to such limitation as the Chairman or the President may prescribe, shall appoint such attorneys-in-fact, as may be necessary to act in behalf of the Corporation to make, execute, seal, acknowledge and deliver as surety any and all undertakings, bonds, recognizances and other surety obligations. Such attorneys-in-fact, subject to the limitations set forth in their respective powers of attorney, shall have full power to bind the Corporation by their signature and execution of any such instruments and to attach thereto the seal of the Corporation. When so executed, such instruments shall be as binding as if signed by the President and attested to by the Secretary. Any power or authority granted to any representative or attorney-in-fact under the provisions of this article may be revoked at any time by the Board, the Chairman, the President or by the officer or officers granting such power or authority.

ARTICLE XIII – Execution of Contracts: Section 5. Surety Bonds and Undertakings.

Any officer of the Company authorized for that purpose in writing by the chairman or the president, and subject to such limitations as the chairman or the president may prescribe, shall appoint such attorneys-in-fact, as may be necessary to act in behalf of the Company to make, execute, seal, acknowledge and deliver as surety any and all undertakings, bonds, recognizances and other surety obligations. Such attorneys-in-fact subject to the limitations set forth in their respective powers of attorney, shall have full power to bind the Company by their signature and execution of any such instruments and to attach thereto the seal of the Company. When so executed such instruments shall be as binding as if signed by the president and attested by the secretary.

Certificate of Designation – The President of the Company, acting pursuant to the Bylaws of the Company, authorizes David M. Carey, Assistant Secretary to appoint such attorneys-in-fact as may be necessary to act on behalf of the Company to make, execute, seal, acknowledge and deliver as surety any and all undertakings, bonds, recognizances and other surety obligations.

Authorization – By unanimous consent of the Company's Board of Directors, the Company consents that facsimile or mechanically reproduced signature of any assistant secretary of the Company, wherever appearing upon a certified copy of any power of attorney issued by the Company in connection with surety bonds, shall be valid and binding upon the Company with the same force and effect as though manually affixed.

I, Renee C. Llewellyn, the undersigned, Assistant Secretary, The Ohio Casualty Insurance Company, Liberty Mutual Insurance Company, and West American Insurance Company do hereby certify that the original power of attorney of which the foregoing is a full, true and correct copy of the Power of Attorney executed by said Companies, is in full force and effect and has not been revoked.

IN TESTIMONY WHEREOF, I have hereunto set my hand and affixed the seals of said Companies this 14 day of April, 2022



By: Renee C. Llewellyn
Renee C. Llewellyn, Assistant Secretary

PART II ▶
**PROJECT TEAM,
EXPERIENCE,
AND APPROACH**



PART II

PROJECT TEAM, EXPERIENCE, AND APPROACH

KEY PROJECT PERSONNEL

The organizational chart on the following page provides key personnel's specific responsibilities, authority, and accountability and discusses how these team members will interact with each other and other entities involved in the Project. Resumes for the following key team members demonstrating their performance in their roles are provided in **Appendix A**. PCL-Stantec commits all the key personnel identified below for the duration of the project.

TEAM MEMBER	ROLE ON ROEMER WFF PROJECT
Jeff Newman, PE	Project Executive
Jim Borchardt, PE	Engineering Manager*
Ken Slota, PE, DBIA	Advisory Council*
Sean Neprud, PE, LEED AP	Design Manager*
Darren Wright	Design-Build Manager / Commissioning Lead*
David Griffin	Design-Build Construction Manager
Craig Yukabow	Lead Estimator
Kevin Schow	Superintendent
Craig Wilcox, PE, SE, P.ENG, LEED AP BD+C	Design Quality Control Manager
Tyler Hadacek, PE	Process Engineer
Long Hoang, PE	Electrical Lead
Simon Lin Ph.D., PE SE	Structural Lead
Christopher Mote, PE	Civil Designer
Eric Sanchez, LEED AP BD+C	Architectural Lead
Sanki Sankaran, PE	Instrumentation & Controls
George Tey, PE	Mechanical Engineer

**Key personnel's roles have changed since the SOQ submission*

EXHIBIT 1 PROJECT ORGANIZATIONAL CHART

Successful projects are based on a combination of people with the right leadership skills, a commitment to actively engage with the project's stakeholders, and strong project management tools. Our project management approach is centered around employing the right staff at the right time to deliver the Roemer WFF Upgrades and Expansion project.



LEGEND

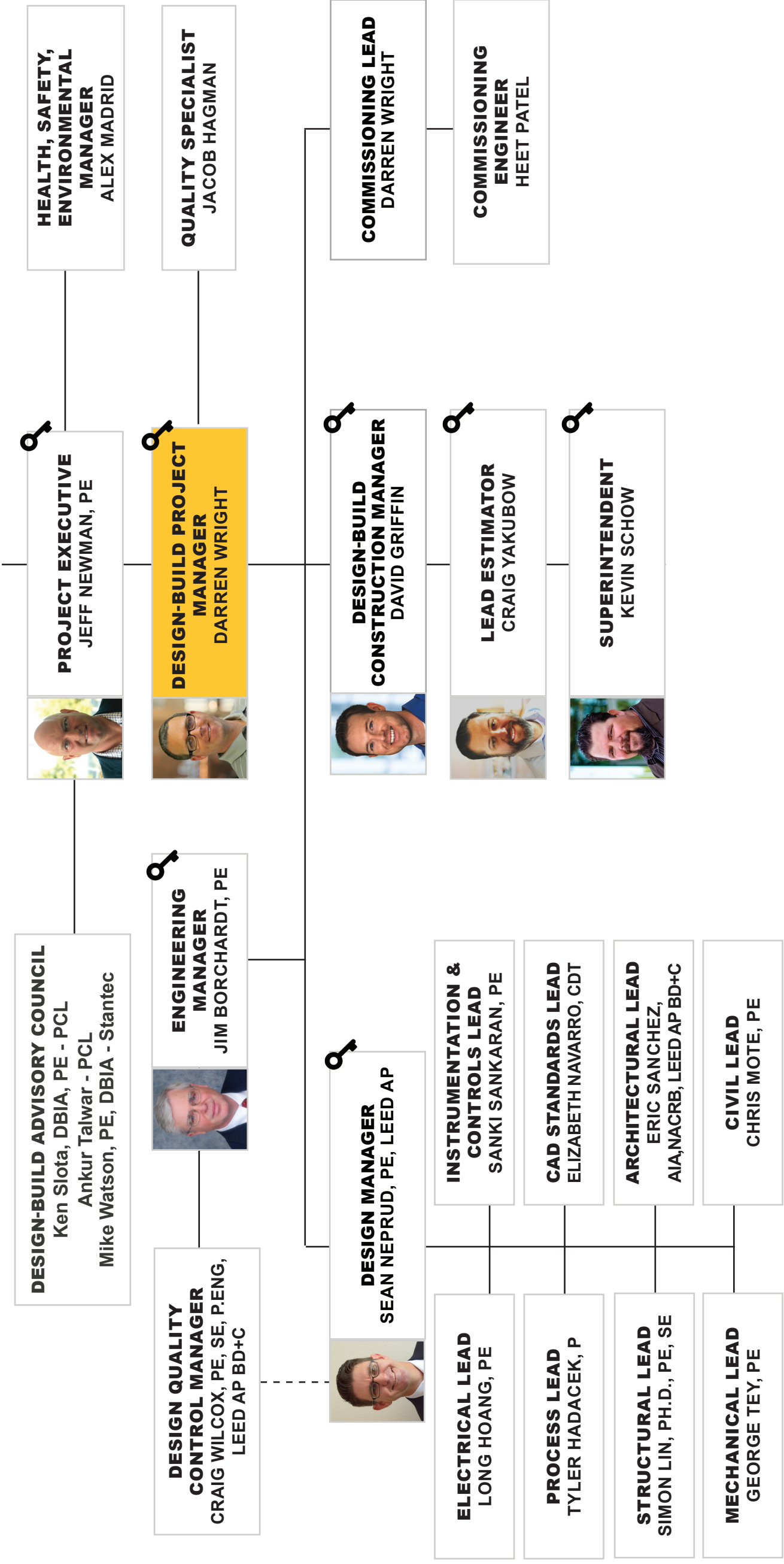

ADDITIONAL TEAM MEMBERS AND EXPERIENCE (ADDED SINCE SOQ)

Key Subcontractors

We have enhanced our team by adding LEED Electric, Inc. for electrical and instrumentation and ACCO Engineered Systems for the HVAC scope of the project.



PCL and **LEED Electric** have an established and successful working relationship on several treatment plant projects in the Southern California area. Our teams have worked closely together and have been instrumental in delivering successful projects. LEED also has experience with design-build projects and has worked with our design-partner Stantec. LEED will bring the design assistance needed to complete the electrical and instrumentation scope for this project and work closely with Plant Staff for the integration of this work.

Beavens Systems Incorporated will work under LEED Electric for the SCADA integration work.

UNIQUE QUALIFICATIONS AND BENEFITS

- Certified Small Business Enterprise (SBE) by the State of California Department of General Services.
- Water Treatment Plant Experience
- Integrated Electrical, Instrumentation & Controls Systems Contractor



ACCO Engineered Systems will provide HVAC services and installation for this project. ACCO has extensive treatment plant experience and a long and successful history of working with PCL. ACCO understands the subtle variations needed to address HVAC requirements for projects just like Roemer WFF. They have the engineering support, established quality standards, and installation experience to install a modern, highly efficient system that will last for years to come.

UNIQUE QUALIFICATIONS AND BENEFITS

- Specialized in HVAC Design-Build services and installation
- Water Treatment Plant Experience
- In-house engineering, fabrication, installation, and commissioning

TEAM EXPERIENCE

The PCL-Stantec Team has delivered over **75 projects totaling over \$9.4B+ in Design-Build projects** in North America including one of the largest Design-Build Water Treatment facilities that treats up to 315MGD for the San Francisco Public Utilities Commission - the Tesla Water Treatment Plant Ultraviolet Facility.

PROJECT EXPERIENCE: The following projects, fully detailed in the SOQ response, further demonstrate our team’s experience working together on similar projects.



TESLA WATER TREATMENT FACILITY

RELEVANT FEATURES

- PACKAGED FILTER EXPERIENCE
- DISSOLVED AIR FLOATATION (DAF)
- PUMP STATIONS EXPERIENCE
- UV DISENFECTION
- ALTERNATIVE DELIVERY
- WATER TREATMENT

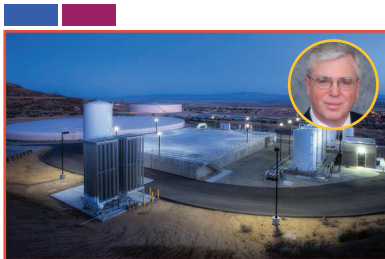

DISINFECTION BY-PRODUCT CONTROL PROGRAM



EPCOR WATER SERVICES, INC



LAKE OSWEGO WATER TREATMENT PLANT UPGRADES & EXPANSION

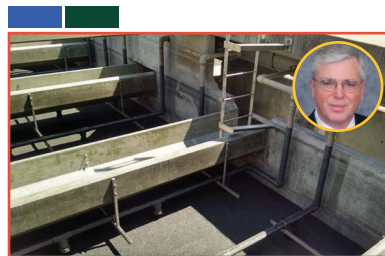

WEYMOUTH WTP FILTER REHABILITATION DESIGN AND CONSTRUCTION



MINERS RANCH WATER TREATMENT PLANT IMPROVEMENTS PROJECT

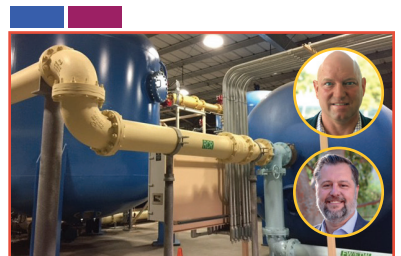

FULL-SCALE FIXED-BED BIOLOGICAL PERCHLORATE DESTRUCTION DEMONSTRATION



SAINT JOHN WATER TREATMENT PLANT

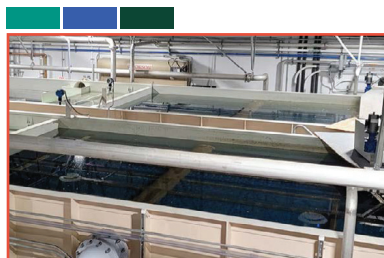

MT. ROSE WATER TREATMENT PLANT

The following pages include three additional, relevant projects that were not included in the original SOQ.

MINERS RANCH WATER TREATMENT PLANT IMPROVEMENTS PROJECT

OROVILLE, CALIFORNIA

The South Feather Water & Water Power Agency's Miners Ranch Water Treatment Plant Improvements Project was designed to expand the treatment capacity of the plant to meet future demands, conserve water during the treatment process, improve disinfection of the treated water, and eliminate backwash water discharge into the agency's Miners Ranch Reservoir. The plant was originally designed to treat up to 14 MGD for potable use – only 3 MGD of which could be treated as full conventional treatment. The improvements increased treatment capacity to 21 MGD with full conventional treatment. The project consisted of the following key improvements:

- Addition of a new raw water pump and raw water pump header
- Addition of a new jet mixing pumping station to reduce coagulant chemical use and improve chemical mixing
- Addition of six new buoyant media upflow clarifiers (WesTech/Trident Adsorption Clarifiers) for preliminary treatment of the raw water that will allow the plant to achieve full conventional treatment year-round
- Addition of two new dual media gravity filters (to augment the existing four dual media filters), as well as new blowers and air scour piping to replace the surface spray system in existing filters
- Addition of a new 2 million gallon concrete treated water reservoir with baffle walls
- Addition of a new gunite-lined backwash water storage basin to work in tandem with the existing basin to settle solids from clarifier and filter backwash water for collection
- Addition of a new waste solids collection and pumping system in the new backwash water basin
- Addition of a new homogenization tank (bolted steel) to further settle solids and decant clearwater as well as mix contents prior to dewatering
- Addition of a new solids handling building (metal) with centrifuge, feed pump, screw conveyor, and solids removal system



CONSTRUCTION COST	\$25 million
COMPLETION	1/2021
KEY PERSONNEL	Stantec
REFERENCE	John Shipman (230) 533-2412 jshipman@southfeather.com

RELEVANCE TO THE ROEMER WFF

- ✓ *Trident Filters*
- ✓ *New Pump Station*
- ✓ *Solids Handling*
- ✓ *Pipelines*
- ✓ *Permitting*

EPCOR WATER SERVICES, INC.

WETASKIWIN, ALBERTA, CANADA

Stantec as lead designer with another firm, executed the design build services for the Wetaskiwin Water Treatment Plant. The source water, Coal Lake, has elevated levels of organic carbon, algae, iron, and UV absorbance resulting in issues with taste, odor, and toxins.

The plant needed to be upgraded to better treat the water, but with an estimated price tag of close to \$20 million, this 12,000-person community could not afford the expenditure. Stantec's Design-Build-Operate team proposed a lower-cost solution that met treatment and regulatory goals – for less than half the cost. This was accomplished through treatment process enhancements and extensive reuse of existing infrastructure. We upgraded the facility with new dissolved air flotation units, granular activated carbon filters, and UV disinfection with enhanced chemical feed systems. The existing controls were completely removed, and a mezzanine level was added to house a new laboratory, electrical room, and control room. All work was completed without unplanned outages.

An existing facility located outside the City is now used for sludge storage, reducing costs and minimizing odor impacts. Now, the residents of Wetaskiwin can rely on Coal Lake and its plant to provide excellent quality water that is clear, fresh, and compliant with new provincial regulations.



CONSTRUCTION COST	\$9 million
COMPLETION	10/2008
KEY PERSONNEL	Stantec
REFERENCE	Glen Sinclair (403) 775-5617 glen.sinclair@aecon.com

RELEVANCE TO THE ROEMER WFF

- ✓ *Design-Build*
- ✓ *Dissolved Air Flotation*
- ✓ *Filtration*
- ✓ *UV Disinfection*
- ✓ *Chemical Systems*
- ✓ *Control Systems*
- ✓ *Continuous Operation*

SAINT JOHN WATER TREATMENT PLANT

SAINT JOHN, NEW BRUNSWICK, CANADA



In connection with a project carried out as a public-private partnership (PPP), Stantec was part of the group-led jointly for the design and construction of a new drinking water production plant serving the City of Saint John, New Brunswick. Under the name Port City Water Partners (PCWP), this partnership was awarded the contract following a call for tenders that saw various pre-qualified groups competing against each other. The selected project consisted of the construction of a drinking water production plant with a 20 MGD capacity. Stantec was entrusted with the critically important responsibility and heart of the project, namely the entire water treatment process and onsite treatment of wastewater produced, to minimize discharge to the sewer system. Stantec helped develop the preliminary design presented in the retained bid and, after that, worked on developing the detailed design along with detailed plans and specifications submitted to the partnership contractor in charge of the construction work. Stantec coordinated the activities of the other disciplines (structure, electricity, building mechanicals, architecture, etc.), which were ensured by another consulting engineering firm.

CONSTRUCTION COST	\$63 million
COMPLETION	6/2018
KEY PERSONNEL	Stantec
REFERENCE	Mr. Dean Price (506) 658-4770 dean.price@saintjohn.ca





RELEVANCE TO THE ROEMER WFF

- ✓ *Design-Build*
- ✓ *Dissolved Air Flotation*
- ✓ *Filtration*
- ✓ *UV Disinfection*
- ✓ *Chemical Systems*
- ✓ *Control Systems*
- ✓ *Continuous Operation*

PROJECT APPROACH

STATEMENT OF UNDERSTANDING OF THE RFP

The Roemer Water Filtration Facility RFP is requesting design-build services to complete the 30% design documents, produced by GHD, and construct the facility's expansion. To successfully accomplish this, we have assembled a highly experienced and innovative design and construction team that will follow the requirements described in the design criteria report and 30% design drawings. Upon completion of design, our team will collaborate with the District to finalize applications with the DDW and SRF. At the same time, we will complete other required permits for the project. Through past project experience, our team has developed the goals and strategies outlined below that have proven to deliver successful design-build projects.

GOAL / OBJECTIVE	DESCRIPTION	STRATEGY
 <p>Innovative Ideas</p>	Through collaboration and open communication, the team will be able to bring innovative ideas that will ultimately deliver a higher quality project and ease of operations.	Establish working sessions with Operations, District Staff, and DB Team to generate ideas, identify challenges, and provide solutions prior during 60% drawing development.
 <p>Project Team Involvement</p>	Maintain involvement of plant operations, District staff, and outside agencies through the Project's Design-Build process.	Establish contacts with operations, District Staff, and outside agencies involved and hold weekly, monthly, or quarterly touchpoints.
 <p>Innovative Cost Model / Schedule Dates</p>	Collaborate and innovate within the project cost model and schedule dates.	Establish time and cost restraints and potential cost/schedule saving opportunities through innovative working sessions.
 <p>Lower Operating Cost while Increasing Operational Flexibility</p>	Deliver a project that lowers operating costs while increasing operational flexibility with current and future demands.	Review project design early on with plant staff.

MANAGEMENT OF THE PROJECT TEAM

Our team will provide WVWD with clear, efficient, and expedited communication throughout the project, which will be facilitated through your single point of contact, Darren Wright, Design-Build Project Manager. All formal communication with WVWD will be routed through Darren, who will engage Sean Neprud, Design Manager, and David Griffin, Design Build Construction Manager, for design or constructed-related items, respectively. Likewise, Sean and David will be responsible for reporting any challenges to Darren. Darren will work closely with Jeff Newman. Jeff serves as the Project Executive and has full authority to provide any resources necessary to the team to successfully deliver the project.

Working collaboratively, our team will identify deliverables and individual responsibilities to ensure everyone involved, fully understands all project elements.

The project charter, shown below, will provide a guide for the team to address functions and processes necessary to execute a successful project. This charter will be a part of the kick-off meeting, ensuring a successful start and will be utilized during execution of this project.

On the following page, we have provided the composition of our team, consistent with our Project Organizational Chart, and have detailed each of our team member's roles, responsibilities, and their reporting structure.

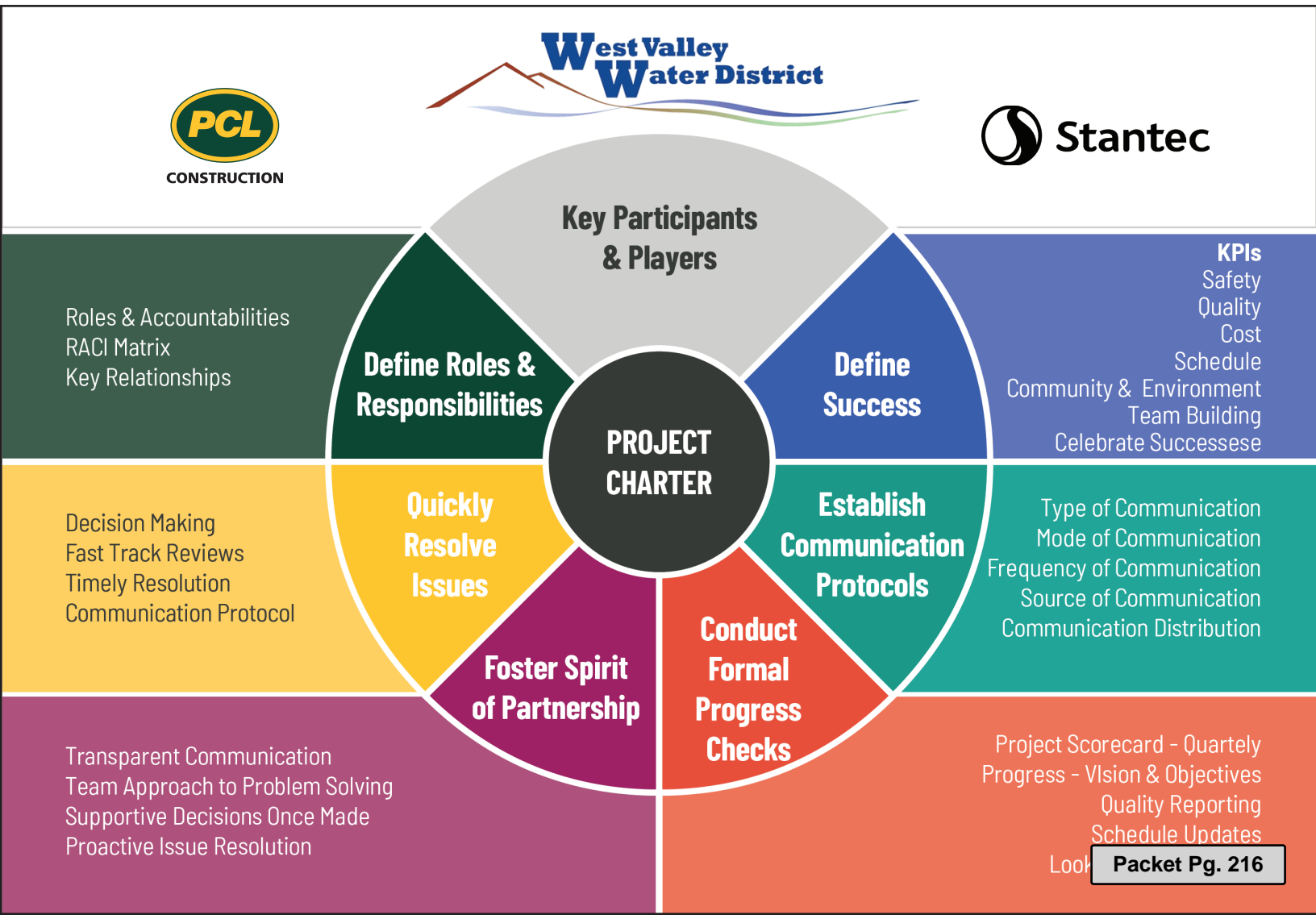

EXHIBIT 2: KEY PERSONNEL MATRIX

NAME AND ROLE AT EACH STAGE		REPORTS TO	RESPONSIBILITIES, AUTHORITY, AND ACCOUNTABILITY
ADVISORY COUNCIL			
Ankur Talwar <i>Advisory Council</i>	Corporate Representative		Ankur Talwar has been involved in the West Valley District's procurement since it's inception. Ankur, a senior manager with 29 years at PCL oversees our California operations and will ensure our team is resourced and will be available for frequent client check ins and as needed.
Mike Watson <i>Advisory Council</i>	Corporate Representative		Mike is a Senior Vice President specializing in alternative project delivery for Stantec's Water Business Line. Mike will ensure alignment between PCL and Stantec on the approach to designing and engage in the project for client satisfaction.
Ken Slota, PE, DBIA <i>Advisory Council</i>	Corporate Representative		Ken will be engaged in the initial set-up and monitor the project due to his extensive experience with Design-Build work and working with Stantec. Ken has completed over \$466 million in Design-Build and other alternative delivery projects and understands how to design and construct within budgeted time and cost. Before working for PCL, Ken was a design engineer on water and wastewater projects and fully understands the overall process and design.
Jeff Newman, PE <i>Project Executive</i>	Advisory Council		Jeff will manage the Design-Build agreement and provide final direction to both design and construction.
Darren Wright <i>Design-Build Manager</i>	Jeff Newman, PE		Darren will report to Ken and will be engaged from the start of design through the completion of the Project. Darren will manage the control of documents and the overall project schedule and will closely monitor constructability issues during the design process. Darren will prepare bid packages for long-lead equipment and manage the overall procurement of the Project. Darren will be the overall construction lead during the Project's design phase and ensure a seamless transition to the construction phase.
Jim Borchardt, PE <i>Engineering Manager</i>	Mike Watson		Jim will be engaged in the initial set-up and monitor the project due to his extensive experience with Design-Build work, knowledge of the Roemer facility and work with PCL. Jim will have responsible charge of all design managers and technical leads working on the project. Jim along with Sean will ensure the contract documents meet the design intent set forth in the Design Criteria Report. Jim has the authority to make final decisions on behalf of Stantec and report this back to Ken and Darren
Sean Neprud, PE, LEED AP <i>Design Manager</i>	Jim Borchardt, PE		Sean will be the day-to-day design lead and be responsible for coordination between the technical leads to produce the project Drawings and Specifications for owner approval, agency approvals, and construction. Sean will report directly to Jim and be the primary point of contact for the District and PCL with the design team. He will coordinate submittal reviews and engineering support for construction activities during construction. Sean will be dedicated to the project 100% from design through construction.
David Griffin <i>Design-Build Construction Manager</i>	Darren Wright		David will participate in constructability reviews and providing information from the field to support design. Once construction begins, Dave will be responsible for successfully delivering the Project, including self-perform activities, subcontractor performance, and working with facility staff to schedule and coordinate the work in the field. He will work closely with Darren and Kevin to resolve issues in the field and identify items to be documented in the as-builts or that require design team input.
Craig Wilcox, PE, SE, P.ENG, LEED AP BD+C <i>Design Quality Control Manager</i>	Jim Borchardt, PE		Craig will manage the quality reviews of the design documents by ensuring that every design report, drawing, and specification has an independent internal review for technical completeness and quality of design. He will apply his extensive experience in engineering design in the water industry to make sure that the design meets the quality expectations of Stantec, PCL, and the District.
Craig Yakubow <i>Lead Estimator</i>	Jeff Newman, PE		Craig will be responsible for developing the fixed price breakdown provided in Proposal Form 7. Craig will be a resource to provide additional backup and information regarding the basis of cost. Craig will also provide estimating services to the Design-Build team to manage changes to scope or pricing exercises. He will report back to Jeff for any final decisions on the Project and will ensure overall budget goals are achieved.
Kevin Schow <i>Superintendent</i>	Jeff Newman, PE		Kevin will participate in pre-construction activities during the design phase. Once field operations begin, Kevin will be responsible for ensuring PCL's field operations practices are in place for a successful project. He will also work with Jeff on proper labor setup with the PLA, CEQA, and SWPPP requirements.
Tyler Hadaček, PE <i>Process Engineer</i>	Sean Neprud, PE, LEED AP		Tyler will lead the development of the process drawings and specifications. Key Technical Leads are accountable to coordinating with other disciplines and meeting project schedule commitments.
Long Hoang, PE <i>Electrical Engineer</i>	Sean Neprud, PE, LEED AP		Long will lead the development of the electrical drawings and specifications. Key Technical Leads are accountable to coordinating with other disciplines and meeting project schedule commitments.
Simon Lin, PhD, PE, SE <i>Structural Engineer</i>	Sean Neprud, PE, LEED AP		Simon will lead the development of the structural drawings and specifications. Key Technical Leads are accountable to coordinating with other disciplines and meeting project schedule commitments.
Christopher Mote, PE <i>Civil Designer</i>	Sean Neprud, PE, LEED AP		Christopher will lead the development of the civil drawings and specifications. Key Technical Leads are accountable to coordinating with other disciplines and meeting project schedule commitments.
Eric Sanchez, LEED AP BD+C <i>Senior Architect</i>	Sean Neprud, PE, LEED AP		Eric will lead the development of the architectural drawings and specifications. Key Technical Leads are accountable to coordinating with other disciplines and meeting project schedule commitments.
Sanki Sankaran, PE <i>Instrumentation & Controls Engineer</i>	Sean Neprud, PE, LEED AP		Sanki will lead the development of the Instrumentation & Controls (I&C) drawings and specifications. Key Technical Leads are accountable to coordinating with other disciplines and meeting project schedule commitments.
George Tey, PE <i>Mechanical Engineer</i>	Sean Neprud, PE, LEED AP		George will lead the development of the mechanical drawings and specifications. Key Technical Leads are accountable to coordinating with other disciplines and meeting project schedule commitments.
PCL ■ Stantec			
KEY PERSONNEL			
KEY TECHNICAL LEADS			

PROJECT MANAGEMENT APPROACH

Our overall management approach is based on our team's history of collaboration and the strength of our established relationship, providing West Valley Water District with a proven, successful design-build team you can trust to deliver.

EQUIPMENT SELECTION

The design-build team will work with qualified vendors and select equipment, based on conformance to design criteria and drawings. Working in collaboration with the District, our team will make sure the pre-selected equipment matches the intended design. All equipment selected by our team will be reviewed with the District and Operations Staff to ensure it meets the same level of quality.

CONSTRUCTABILITY REVIEWS & OPERATIONS TEAM INPUT

Constructability reviews will be conducted at the 30%, 60%, and 90% levels and managed by Craig Wilcox. These reviews will be conducted internally to meet established quality control measures prior to review by the District and Plant Staff. Operations team input will be obtained through constructability reviews and field walks of the process areas during design development.

DESIGN & CONSTRUCTION OPERATION STRATEGIES

Construction strategies are regularly implemented into the design to eliminate constructability challenges. We achieve this by including our construction team members throughout the design phase.

Darren will develop and manage the comment resolution log for design submittals and conduct reviews, workshops, and solicit input at critical design stages to prevent costly changes and surprises.

The team will meet with Union officials to ensure **CWA Compliance** and conduct monthly compliance checks.



HOW DARREN WILL MANAGE THE PROJECT

Aligned and accountable.

Establish clear understanding of expectations, roles, responsibilities, and WVWD-provided services ensuring alignment and accountability in everything we do.

Collaborate and listen.

Engage staff including operations in well-planned and frequent manner. Ensure all comments are heard, addressed, and incorporated into next submittal.

Communicate frequently and openly.

Accurate, meaningful, and timely communication and reporting to facilitate decision making and capture progress including early identification of issues.

Stay focused on risk and quality.

Work continuously to eliminate uncertainty, control risk, and provide quality submittals and facilities throughout the delivery process.

Do great work—on time.

Meet deliverable deadlines and construction milestones with high-quality work that is responsive to expectations and project needs.

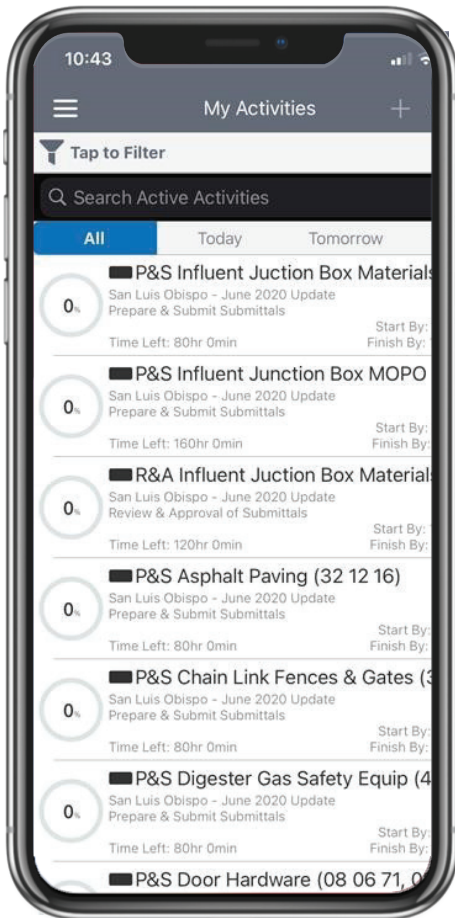

SCHEDULE MANAGEMENT

PRIMAVERA PROJECT PLANNER P6

PCL has been using Primavera scheduling tools for more than 20 years. Our enterprise license agreement with Oracle allows all our engineering and field management staff to use the full P6 Client program on our internal networked database.

The program produces resource-loaded schedules that are web-based, with real-time data, producing reports and charts to track current progress and address future resource requirements. Our team will use P6 to develop the project baseline schedule and continually monitor progress throughout the life of the project. The baseline schedule is the primary tool for tracking the design schedule; coordinating subcontractors, suppliers, and submittals; and provides guidance for the project team regarding issues requiring their input.

Our schedule management process will include phase 1 design activities and phase 2 construction activities in one combined schedule which will be reviewed weekly with the District and other stakeholders. As the design build manager, Darren Wright will manage the execution of the schedule from NTP through project closeout to avoid discontinuity between phases. Darren will ensure design decisions are in alignment with equipment release and delivery milestones and that minor design changes do not cause major construction disruptions. Given the current market disruptions and supply chain challenges, Darren will update fabrication and delivery schedules real time to properly manage design resources to ensure timely delivery of long lead equipment. As key team members, David Griffin and Kevin Schow will work with Darren in the design phase to develop the construction portion of the schedule which will include input from key sub trade partners to verify activity durations.

PCL will also incorporate activities such as required agency permit approvals, financing, long-lead time material procurement, and operation concerns (i.e., weather concerns, shutdowns, tie-ins). We will work closely with each stakeholder involved with the project and create a baseline master schedule structured around the critical path that incorporates all the activities and durations associated with construction.

We have completed a preliminary P6 schedule for the project including all key scopes and milestones during design and included in **Appendix C**. This P6 schedule will be further developed upon award.

Pull Planning

In addition to traditional CPM scheduling, PCL uses the Last Planner System to develop and manage highly detailed schedules for complex projects. Also known as "pull planning," this method of scheduling is particularly useful in planning and tracking concurrent work activities with multiple trades. Starting with the last milestone for a project (plant commissioning), the team works backwards and reviews all work activities with subtrades to capture interdependent relationships and ensure everyone is on the same page.

COST MANAGEMENT

We will manage construction cost through our BEST PM+ program, PCL's online collaboration tool further described in document management, that tracks budgets, subcontracts, purchase orders, change orders, labor cost productivities, and invoicing.

COORDINATION & COMMUNICATION

Communication is key to collaboration and the best way to help mitigate risk and ensure all parties are moving towards a common goal. At the initial kickoff meeting, lines of communication will be established to ensure all stakeholders are engaged in the process. We will utilize a cloud-based site to provide real-time access to drawing and specification updates, meeting minutes, and other project documents.

As the design process begins, we will have weekly workshops that focus on task-specific issues. Design workshop agendas will be focused on specific items and can primarily be managed via Microsoft teams as this allows designers to make real-time changes to documents to capture discussions and

decisions made during these workshops. We will use Bluebeam Studio and Revit 3D BIM throughout the process. Our experience shows using this tool reduces RFIs, reduces construction costs, and optimizes layouts for operation and maintenance. We will track all decisions made during the meetings on a decision log accessible on the cloud. In addition to the weekly workshops, we anticipate holding ongoing meetings with Operations for input, holding multi-day reviews at major design deliverable milestones, and formal meetings to review the CPM schedule and major equipment and subcontractor packages.

Communication with our subtrades and vendors is key to successfully delivering our cost and schedule goals on the Project. We will invite key subs to review the plans and specifications throughout the design process to eliminate inefficiencies during the construction process. We will solicit the same feedback during the preparation of the CPM schedule to ensure we have accurate and obtainable durations and logic.



PCL produced a 3-D model of our recently completed PAR 1280 Project for Metro Wastewater Reclamation District.

PCL utilizes the latest construction technology to ensure **efficient communications** and streamlined processes to monitor the schedule and costs so that we deliver a high-quality project on **schedule and budget**.

The PCL team will use BIM in conjunction with our estimating, scheduling, and planning tools to optimize the project's design and construction with respect to cost, schedule, and quality to add value at every step of the project's life span.

BIM is also an effective tool in helping manage risk for each stakeholder. During the design phase, we will produce 3-D and 4-D models that we will use for clash detection, constructability reviews, scheduling, process pipe shop drawings, concrete lift drawings, and critical lifting plans. By using a model to simulate the design, construction, and operation of a project, we are able to optimize each of these phases before a shovel is put into the ground, avoiding conflicts and issues, minimizing risk, and delivering the project on time and on budget. This effectively allows us to "build the project twice," without actually building the project twice.

DESIGN

The **design process** will take the DCR and 30% drawings, completed by GHD, along with preliminary drawing development that has already been completed between Stantec, PCL, and the major equipment vendors to produce the 60% design. Prior to owner review, Stantec will make the drawings and specifications available for PCL, equipment vendors, and key subcontractors' review to confirm preliminary drawing development agreements. Comments, meetings, and working sessions will need to occur during this specific review time to maintain the design schedule. Once internal reviews have been completed, the drawings will be submitted to the owner for review.

At the 60% design stage, we will deliver a list of remaining long-lead items, prepare an overall procurement plan, prepare the initial maintenance of plant operations plan (MOPO), review the initial control strategy, and develop the initial construction work plan. The CPM schedule will be updated based on material procurement and feedback from the subcontracting community. The project procurement plan will be the road map for the successful execution of the Project and will establish how the Project will be broken down into distinct work packages. This approach will provide the opportunity to accelerate the schedule and reduce supply chain and budget risk.

At the 90% design, subcontractor and vendor packages will be finalized, preliminary testing startup and commissioning plans will be developed, and the CPM schedule will be finalized. At this time, the preconstruction and work assignment meeting required by the PLA will be conducted.

CONSTRUCTION ADMINISTRATION

Construction administration will be conducted by PCL's onsite supervision. It is not anticipated for Stantec to have a resident engineer onsite full time. PCL will hire third-party special inspectors to conduct the code-required inspections. Per initial discussions, GHD will be onsite to serve as the owner's agent. PCL will work closely with GHD to ensure work is installed according to the approved documents. PCL will also manage the schedule to ensure both design and construction meet their dates.

INFORMATION FLOW, DOCUMENT MANAGEMENT AND RECORDS CONTROL

Keeping comprehensive project records is essential to efficient project execution. To maximize collaboration between project stakeholders and provide easy access to the most up-to-date records and documents, PCL developed a proprietary online collaboration tool called PM4+. This centralized system houses electronic files and project documents like drawings, specifications, submittals, RFIs and as-builts in an archive that can be accessed any time. This application can also generate transmission and record document distribution.

All project stakeholders have full access at all times, eliminating the need to request documents and taking the guesswork out of where to find exactly what you may be looking for at any given time.

As the Design-Build Construction Manager, David will be ultimately responsible for maintaining the formal records in PM4+ and distributing all contracts documents.

PM4+ is a single-source solution providing speed to execution, reducing duplication and lean process management; real-time information for the entire project team; access to everything project-related in one place; and cloud-based working on the go.

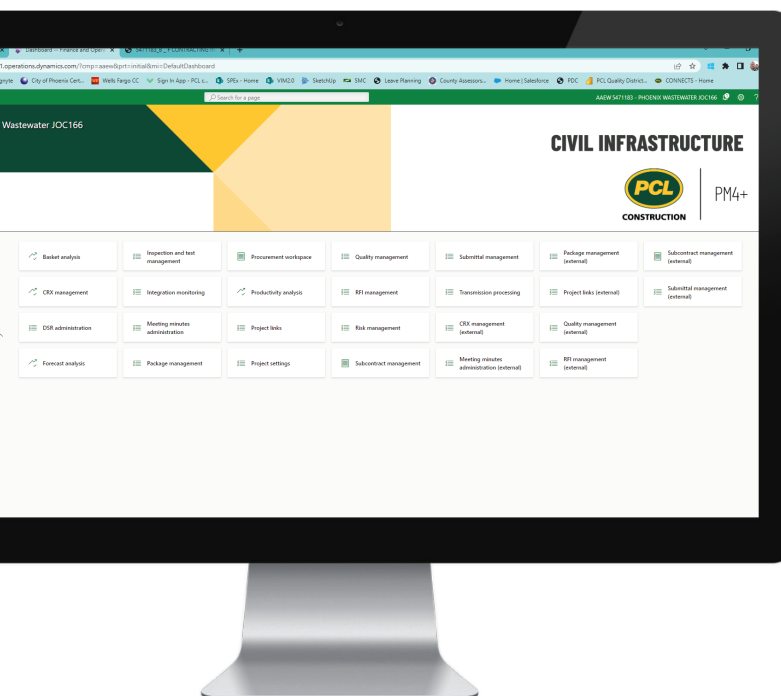

PERMIT REQUIREMENTS & UPDATES

Our team is highly experienced in leading the permitting efforts to support accelerated project timelines. Success in navigating this process relies heavily on early coordination between the project team to identify all required permits, populate a project-specific permitting matrix, and engage permitting agencies to understand their unique requirements.

A permit acquisition plan will be established during the project kick-off phase to narrate specific deliverables required at each stage and the responsible party. This provides accountability and adherence to deliverable dates to avoid delays. Conformance review of each permit will be conducted to ensure program changes are identified and tracked in the permit acquisition plan.

The District will lead the DDW permitting process. Quarterly meetings will be held with the District to inform the design-build team. The technical report, design criteria, and application for amendment will be developed to receive the temporary permit to operate and begin the 30-day performance / acceptance test. It is anticipated the District will receive their final permit to operate a few months after project completion.

The design team will take the lead on the 30" pipeline, Riverside Avenue improvements, Cedar Avenue driveway approach and 2" water meter with the City of Rialto. The city plan check office has been informed of the upcoming work and review durations have been included in the schedule. We do not foresee any schedule constraints with obtaining permits with the City of Rialto.

The SCAQMD Generator permit to construct and operate will be filed by a 3rd party consultant experienced with generator permits. The Caterpillar Model 3512C Diesel Standby Generator is pre-certified for emergency standby power with Tier 2 emissions levels. The generator is also more than 1,000 feet from Wilmer High School and will not require a Diesel Particulate Filter. We do not anticipate any issues with securing the SCAQMD permit.

4.3.1. ENVIRONMENTAL MANAGEMENT

The CEQA Mitigation, Monitoring, and Reporting Program will be followed in a format similar to our Safety Programs. PCL realizes the impacts construction has on the environment; therefore, we have included Environment in our HSE (Health, Safety, Environmental) Program. Most of the requirements are already included in PCL's standard HSE Program and Practices. PCL and Stantec will review before 60% design to ensure opportunities are not missed to engineer or design around a potential issue. We anticipate an emphasis on air quality and dust control within the facility. Stormwater, noise, and vibration mitigation are anticipated during the installation of the 30-inch line to the reservoir.

4.3.2. DESIGN BUILD QUALITY CONTROL PLAN

TRIED, TESTED, AND TRUE: QUALITY CONTROL PROCESSES

The team's Quality Management Program is based on the commitment to continually improving quality by identifying and correcting challenges so they do not reoccur. The critical steps required to build right the first time include monitoring the process, inspecting, verifying and documenting implementation of any necessary changes. High quality is continually achieving or exceeding compliance to standards, specifications and regulations.

Quality is a culture instilled within every one of our team members. This mindset is part of our team's culture; we are committed to excellence and leadership in quality.



**BUILD IT
RIGHT
BUILD IT
ONCE**

To us, quality means continually achieving or exceeding compliance to standards, specifications, and codes / regulations. This mindset is part of PCL's culture as we are committed to excellence and leadership in quality.

QA/QC DURING DESIGN - DOCUMENT CONTROL & RECORDS MANAGEMENT

- 1 A quality control process implemented by our discipline leads who set the design standards used across all design packages.
- 2 An independent technical review (ITR) team led by our Quality Manager who conducts and documents independent reviews at key milestones during design.
- 3 Performing and documenting field inspections, pressure testing, leak testing, and key inspections by the Engineer of Record.
- 4 Coordinating and scheduling required materials testing and special inspections with the Owners Engineer/Agent.
- 5 Documentation and record keeping of all quality control reports for final project close-out

KEY STAFF RESPONSIBLE FOR QUALITY CONTROL & ASSURANCE

Craig Wilcox will lead the design development quality control reviews and follow design standards and technical reviews between disciplines. We will schedule workshops to engage early development of the drawings with the District to ensure design development is meeting Districts expectations.

PCL's Quality Specialist, Jacob Hagman, will assist the project team in completing the development of the quality control in the field. Jacob will ensure the field team adheres to PCL's quality control standards.

BENEFITS OF OUR QUALITY MANAGEMENT APPROACH

- **Independent verification for a high degree of confidence.** An independent review team led by the Quality Manager and key technical and construction professionals will perform design and constructability reviews at all project milestones for each package prior to submission to WVWD.
- **Technology-assisted reviews for enhanced visual clarity and decision-making.** Experience has shown us the value of using BIM and VR design tools to drive an integrated approach to project design, construction, and asset management. Our BIM model will be used for multidisciplinary clash detection, and for regular reviews of the project in 3D and VR with key stakeholders representing engineering and plant O&M with supplemental formal reviews of design packages to expedite and more thoroughly involve these key stakeholder groups in the review process. We find this approach engages O&M staff early and often throughout the design process. This approach also makes the review process more efficient by reducing the risk of surprises when reviewing the formal milestone submittals.
- **Collaborative engagement with WVWD and the owner's engineer.** We propose regular reviews of the design concepts with key WVWD internal stakeholders including engineering, and O&M staff. Early and frequent engagement improves the efficiency of the review process by reducing the risk of issues and schedule impacts.
- **Documentation of quality control by ITR and reviewers** to log any issues identified as well as corrective actions required.
- **Precise documentation and superior writing quality.** All design quality reviews (internal and external) are documented using quality review forms and drawing redlines. We assign one of our senior engineers to quality manage all technical writing to assess clarity and accuracy.

TEAM PARTNERSHIP ENVIRONMENT

SCHEDULE DURING DESIGN DEVELOPMENT & DISTRICT INVOLVEMENT

An “Early Works” package will be completed to release long lead items so that construction may begin as soon as possible. The District will be involved throughout the process. This early works package will include the major equipment and underground piping. **Design workshop agendas** will be focused on specific items and can mostly be managed over Microsoft Teams. This allows designers to make real-time changes to documents, incorporating decisions made during these workshops. Key issues for refinement will be exposed pipe routing, valve placement, operator maintenance, layout of the SCADA room and laboratory.

COMMUNICATION & THE PM ROLE

Weekly meetings will be held to discuss action items and track project status. We believe the most productive approach is to identify breakout sessions that involve the relevant stakeholders to get more specific in the details and provide resolution. Higher level management meetings will be scheduled periodically to ensure the desired collaboration is occurring within the team. Weekly meeting minutes will be recorded, review of the 3-week look-ahead schedule will occur and monthly status reports will be utilized to track project progress. David will have direct control of the work in the field and decision making power regarding direct labor, subcontractor management, extra work orders, schedule changes and coordinating with Operations. David will be involved in further schedule development and any resequencing required.

Interactive Design Workshops USING BIM AND VR

A proven strategy for fostering communication and collaboration is workshop-style meetings throughout the design process, which includes the design-build and client teams to make key decisions regarding the direction of the project.

Prior to these meetings, we prepare detailed agendas, discussion papers, technological alternatives, technical memos, and cost alternatives, allowing for meaningful engagement and decision-making. We will also hold critical decision meetings to allow the design process to progress uninterrupted and to keep WWD informed.

These meetings will be led by Sean and attended by members of the design delivery team as required. We will also set up a decision log to document key decisions from meetings and workshops and provide accountability and transparency in the decision-making process.

We will also show live BIM 3D model walkthroughs and flyarounds during the design phase to key stakeholders from WWD and the community. We find highly visual and interactive demonstrations like these enhance discussion among stakeholders, O&M staff, design and construction team members, and increases collaboration and team-building among all team members.

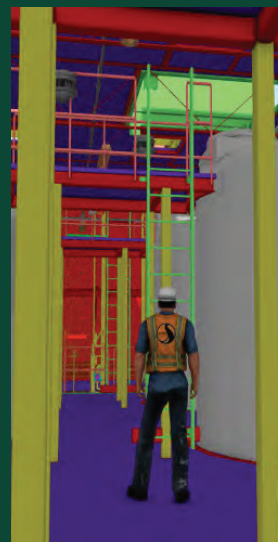

Stantec hosted two VR sessions for the East Bay Municipal Utility District Chemical Systems Safety Improvements project.

The team viewed the federated 3D model of the Orinda WTP 50% design using Oculus Rift headsets, and plant staff and stakeholders could navigate a walkthrough of the model.

These sessions allowed engagement with O&M staff and facilitated the collection of design review comments to supplement traditional drawings and specifications review.

PART III ▶
**TECHNICAL
APPROACH**



PART III

TECHNICAL

APPROACH

4.4.1. TREATMENT PROCESSES, EQUIPMENT SELECTION & CAPACITY

DESIGN CRITERIA REPORT UNDERSTANDING

The Request For Proposal was accompanied by a Design Criteria Report (DCR) that developed the requirements of this Project to a 30% level of completion. In general, the DCR will be used as the basis of design.

Our approach will be to develop the requirements of the DCR to a final design level and construct the Project according to that final design. For some of the project elements, the final design will closely match what is described in the DCR; for others, *the design will differ from the DCR requirements in ways that will improve longevity, flexibility, reliability, and project costs.**

In the following sections, we describe our approach to designing this Project and explain in more detail our engineering design process and where we intend to differ from the DCR. There are many elements described in the DCR that are not described below; these range from valve and instrumentation requirements to modifications of existing facilities and more. ***Therefore, where we have not commented on an item defined in the DCR, we intend to proceed with that element using the DCR as the Basis of Design.***

TREATMENT OVERVIEW

The primary treatment equipment that we will furnish will add 7.2 million gallons per day (MGD) of treatment capacity to the existing treatment plant. Improvements are located on the site layout on the following page in **Figure 3.1**. We will tie into the existing 30-inch influent line from Influent Blending Pond 1 with a new 30-inch line that will convey water to the suction of a new Influent Pump Station. Water will be pumped to three new clarifier/filter units located in a new Filter



* Represents a design innovation that enhances longevity, flexibility, reliability, or project costs.

Building addition. The effluent from the new filters will tie into the existing effluent pipe from the existing filters, pass through three new UV Reactors, and then discharge into the existing Chlorine Contact Tank.

We will cut into the existing 24-inch gravity outlet pipeline from the contact tank, increase it in size to 30-inches, and feed water by gravity to a new Effluent Pump Station that includes overflow pipes to Recovery Pond number 5. Water will be conveyed by the new Effluent Pump Station through a new force main routed to the northeast side of the site and continue in W. Via Bello Drive to existing reservoir R5-2.

In the existing Filter Building, we will replace the existing UV Reactors with new UV Reactors (as described above), replace existing UV recovery pumps with new vertical turbine pumps, replace the existing GAC pumps with new split-case horizontal pumps, and replace the existing air blowers and air piping.

We will install three Dissolved Air Flotation (DAF) units for solids removal. Existing piping will be modified so that water can be directed to the DAF units from Backwash Recovery Ponds 1 through 6 or from a sludge cycle at the pre-treatment facility. To accommodate fluctuations in the amount of water that are to be treated by the DAF units, water will be directed into a 50,000-gallon equalization tank and pumped from the tank to the inlet of the DAF units. Polymer will be stored in the vicinity of the DAF units and dosed upstream of the inlet to the DAF units, and mixed into the water using a static mixer.

We will also be replacing the pumps in several locations. The UV recovery pumps will be replaced with larger pumps sized to handle the new maximum flow. The GAC Influent Pumps will be replaced with new larger pumps with VFD control to divert one-third of the UV effluent to the GAC vessels. The decant pumps at Recovery Ponds 1-4 will be replaced, and similarly, the decant pumps at Recovery Ponds 5 and 6 will be replaced.

Figure 3.1: Summary of Plant Improvements

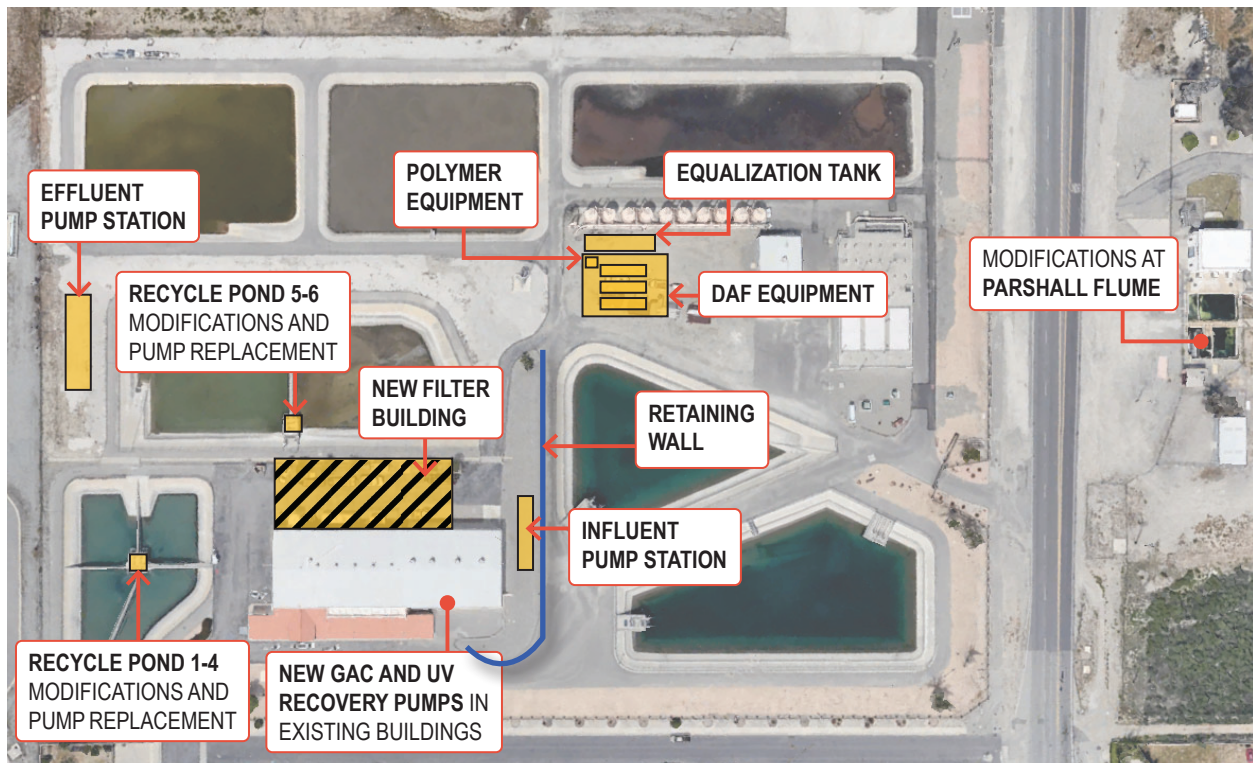

TRIDENT CLARIFIER/FILTERS

The new Trident Clarifiers/Filter units will expand the existing plant capacity of 14.4 MGD to 21.6 MGD and allow an additional increase with future Trident units to up to 30.4 MGD total plant capacity. We will provide three Trident units consisting of an upflow clarifier section and a downflow filter section, similar to the existing Trident units already installed onsite. The new units will have the same per-unit capacity as the existing filters, with similar operation.

One difference between the existing Trident filters and the new filters provided is the backwash/surface wash function. A two-step process cleans the existing filters: first, a water surface wash uses pressurized water from the Surface Wash Pump Station for a surface scour of the filter media; and second, a filter backwash delivers reverse flow through the filter media. Instead, the new filters will use an air scour for the surface wash, followed by a water backwash reverse-flow cycle.

Our design approach recognizes that in order for the design of the new filters to be complete, the pre-engineered building and the building footing must be progressed far enough to avoid conflicts between the piping

and the footing and allow access space between the building and the instruments and piping. This is why our design approach will prioritize finalizing the filter arrangement and requirements with manufacturer and also prioritizing the design of the pre-fabricated building. These two activities will begin as soon as possible after receiving the Notice To Proceed. We will use the information from the pre-fabricated building supplier to finalize the foundation requirements, and then adjust or finalize our preliminary underground pipe layout to coordinate with structural slab and footing requirements.

The underground piping is one of the crucial elements of the filter design, with four significant design considerations:

1. The underground piping will be designed to allow an above-ground piping layout that allows access to valves, meters, and other equipment.
2. The underground piping will be designed so that is not underneath the building footing.
3. The piping will be designed to be accessed and modified in the future to accommodate future filters.
4. The effluent piping will tie into the existing filter effluent.

SUCCESSFUL TRIDENT FILTER INSTALLATION

Stantec provided urban land engineering services to the construction and commissioning of a 4.0 ML/d (1.06 USMGD) water treatment plant for the City of Enderby.

The plant was designed to incorporate absorption clarification and rapid rate filtration via a packaged treatment plant. Initially one plant consisting of an upflow clarifier followed by filtration was installed. The building and clear well were designed to incorporate a second packaged plant, with a building addition planned for a third plant to bring the total capacity to 12 ML/d.



EXHIBIT 3: NEW FILTER BUILDING PLAN AND SECTION

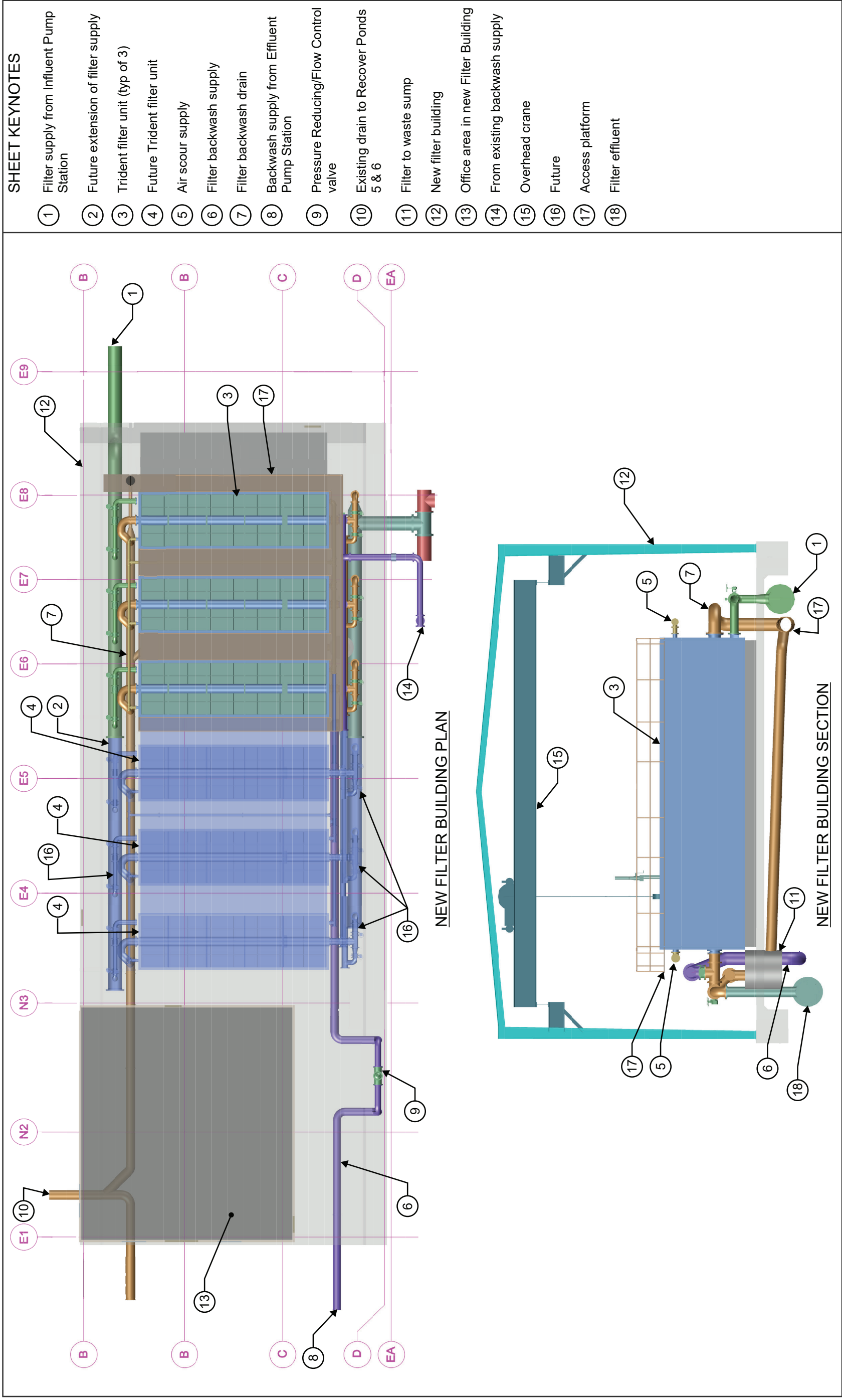

EXHIBIT 4: NEW FILTER BUILDING (3D VIEW)

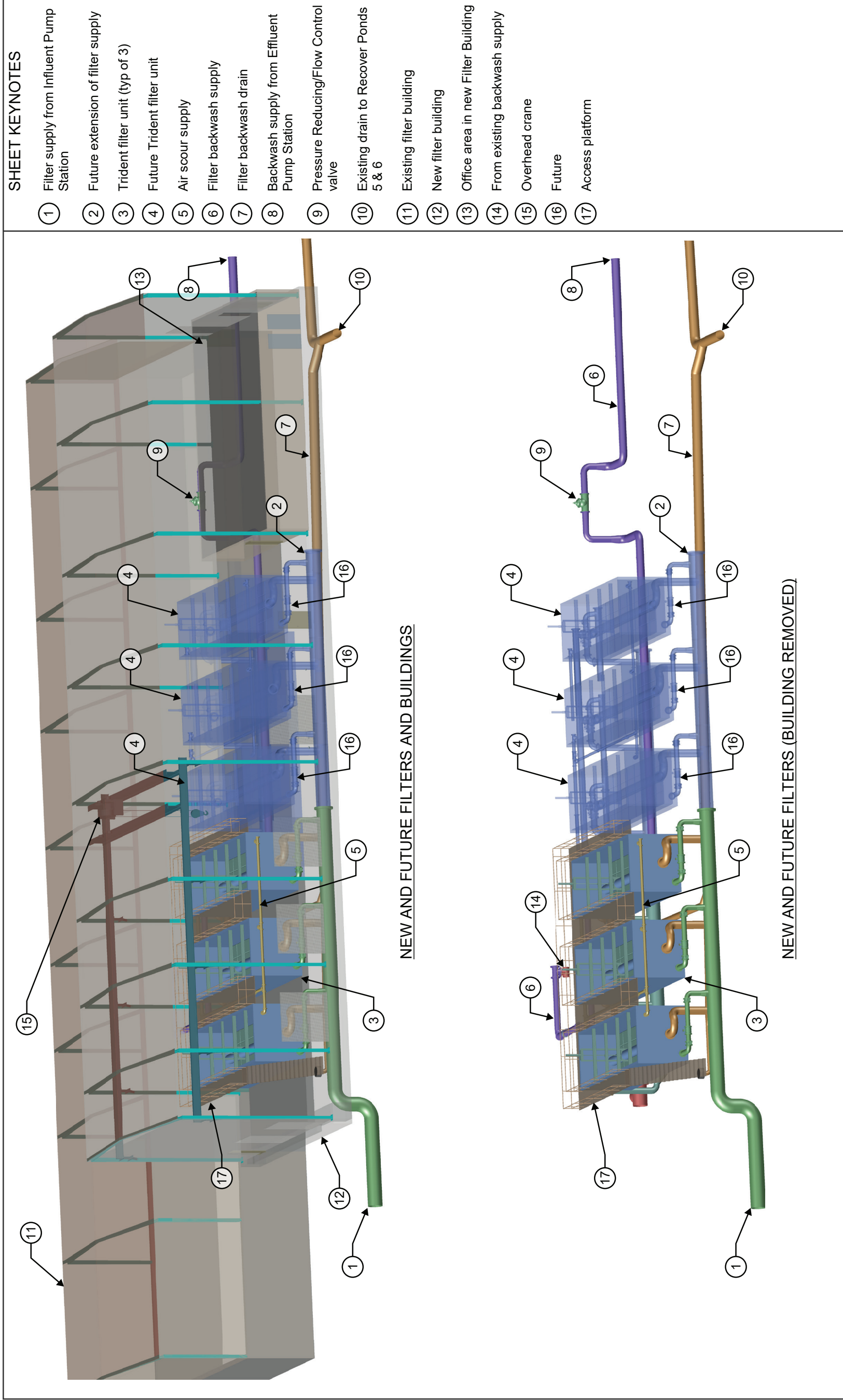
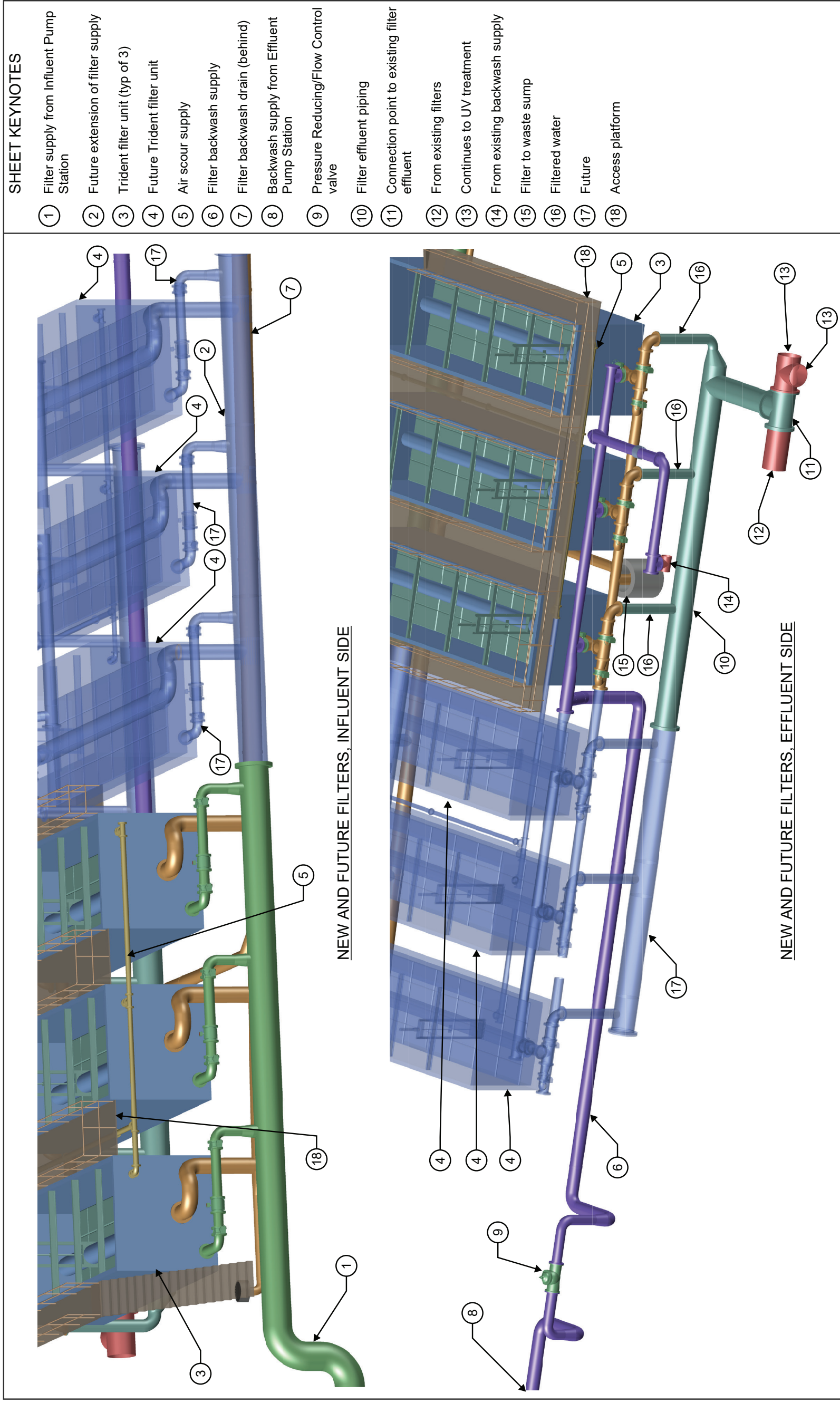

EXHIBIT 5: NEW FILTER BUILDING (3D VIEW OF INFLUENT AND EFFLUENT SIDES)



We evaluated the piping design in the DCR and have made some modifications for this proposal. Our design moves the Filter Influent and the Backwash Waste drain closer to the center of the building so that no pipes are located under the building footing. The backwash waste piping will be hard piped directly into a 24-inch drain, and a catch basin for the filter-to-waste piping will be installed on the effluent side of the filters. The filter-to-waste piping will discharge into a common header and then deposit water into the catch basin with an air gap to satisfy DDW requirements. We have confirmed with the manufacturer that this change will not restrict the performance of the filters.



We will design the new filters for longevity to maximize the useful life of the equipment. The oldest of the existing Trident filters have been in service for nearly 30 years, with more useful years of service likely. The filters and piping possibly have 30+ years of useful life. Valving is expected to have a useful life of at least 20 years before replacements or refurbishment is required. The instrumentation has a useful life of 15 years. West Valley can expect several decades of useful service life from the Trident filters with proper operation and upkeep.

UV REACTORS

New UV Reactors will replace the existing reactors located in the UV reactor gallery on the lower level of the existing Filter Building. The selected equipment is by Trojan SWIFT, the model number is 4L24, with a design flow up to 15.2 MGD. The lay length of the new reactors is the same as the existing reactors, which will facilitate placing the new reactors where the existing reactors are currently located.

In addition to the new reactor itself, we will replace the electrical panels and controls for the UV Reactors. The result will be entirely new UV treatment equipment with the capacity

to treat current flows and future Phase 2 plant capacity without the need for any additional upgrades and also maintaining the 2 duty/1 standby configuration of the reactors.

With regular maintenance of the UV Reactors, we can expect a lifespan of 25 to 30 years. See below for more information from the manufacturer regarding the useful life of consumables used in the UV system. Because of current supply chain issues, we recommend early discussion about procurement and storage of replacement UV lamps, sleeves, and other consumables to ensure uninterrupted service.

UV System Lifecycle (Useful Life)

UV Lamp: 12,000 to 14,000 hours
 UV Drivers: 10 to 15 years
 Control Panel: 20+ years

DISSOLVED AIR FLOTATION (DAF) AND EQUALIZATION BASIN

The DAF units will add a robust solids removal solution for the backwash wastewater and the waste from the sludge cycle of the pre-treatment system. In our conversations with the District, our understanding is that DAF has been an effective system for the District at another location. Therefore, we will install similar DAF units to the existing system at the Roemer facility.

The DAF will treat water from three sources. The first two water sources is backwash wastewater from either Recovery Ponds 1-4 or Recovery Pond 5 and 6. This water consists of water from the Trident Filter backwash and filter-to-waste cycles. This water is collected in Recovery Ponds 1-5 and will be pumped to the Equalization Tank from the Decant Pumps at Recovery Ponds 1-4 and the Decant Pumps at Recovery Ponds 5 and 6. The third water source is

the sludge cycle at the pre-treatment area. This will allow any pump or DAF unit to be out of service and still run the plant at the full design capacity.

The Equalization Tank will be a 50,000 gallon concrete tank. This size will hold the water from two complete sludge cycles at the pre-treatment facility. Self-priming wastewater pumps located next to the Equalization Tank will pump water from the Equalization Tank to the inlet of the DAF units. The pump station will be a 2+1 configuration, with each pump sized to match the flow required at the inlet of each of the DAF units. VFD will control these pumps. As we design the equalization pumps, we will leave space for a future fourth pump so the facility can be expanded to put all three DAF units into operation and still maintain a standby pump.



One of the challenges we anticipate with the equalization tank is the settling of solids. In this proposal we have proceeded with the 50,000 gallon equalization tank required by the DCR to accommodate two sludge cycles from pre-treatment. During detailed design we will study the plant operational flows to confirm this size and reduce the volume if possible. A reduced volume will reduce settling time.

The arrangement between the equalization basin, the equalization pumps, and the DAF units will be designed to allow for flexibility. Each DAF unit will be fed by an individual supply pipe from the equalization pump station, and each pump will be able to feed to two of the DAF units. This will allow any pump to be out of service or any DAF unit to be out of service and still run the plant at the full design capacity.



Each DAF unit will include two recycle pumps and one air saturation vessel to provide the dissolved air source. In addition, a single air compressor and receiver station will be installed at the DAF units that will provide air for all of the DAF units.

Our proposed DAF system will collect the sludge from each of these units by a gravity feed into a sump and then be pumped by a wastewater pump to the sludge drying beds. We are proposing this arrangement instead of the progressive cavity sludge pumps piped directly to the DAF outlets shown in the DCR because this will allow the units to be drained and cleaned without the progressive cavity pumps limiting the maximum flow rate out of the drain ports at the bottom of each DAF unit. This will provide both greater functionality and flexibility to operating staff.



Packaged DAF Thickeners under construction, designed by Stantec.



EXHIBIT 6: DISSOLVED AIR FLOTATION FACILITIES AND EQUALIZATION TANK (3D VIEWS)

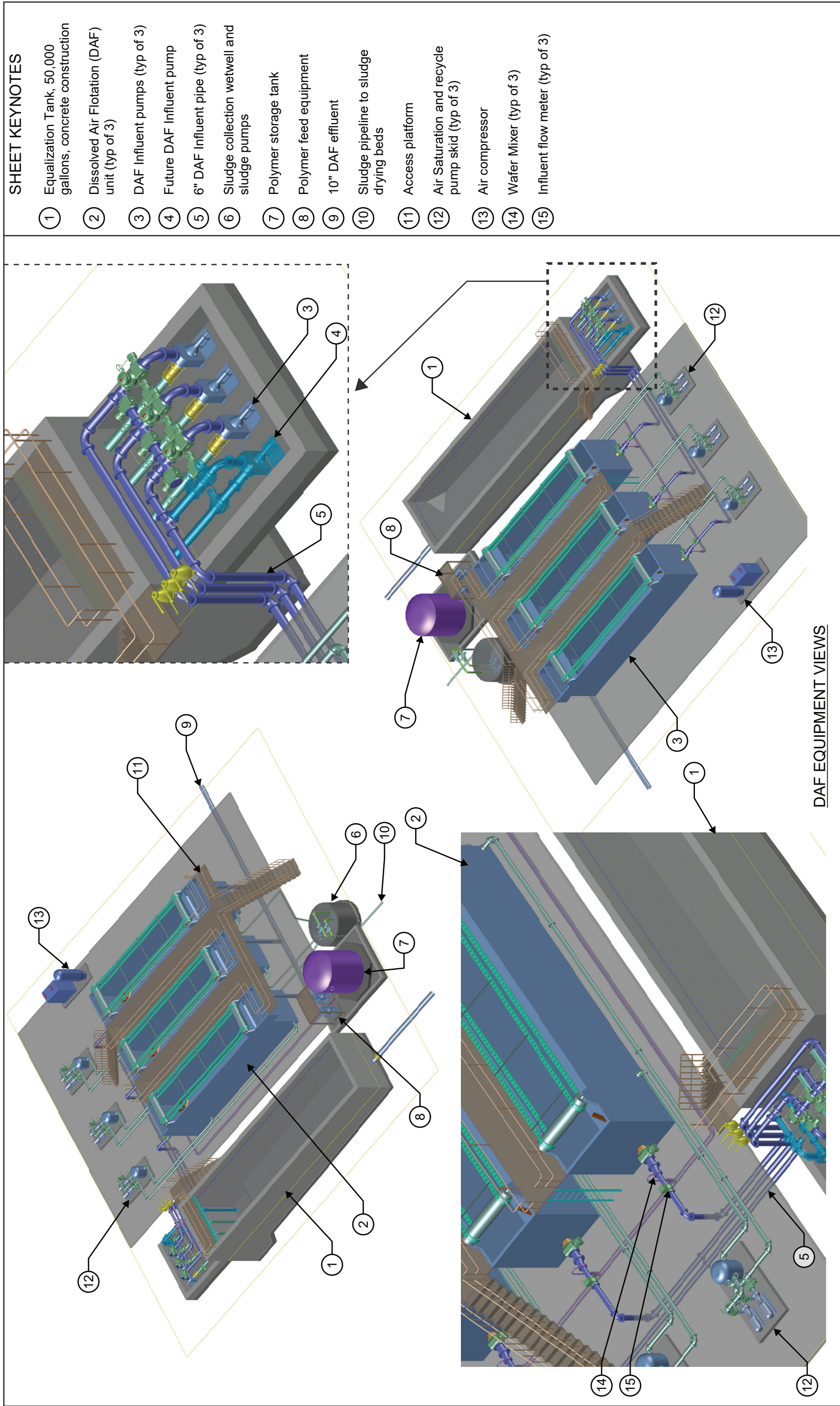

NEW PUMP STATIONS

Two new pump stations will be built - the Influent Pump Station and the Effluent Pump Station. These two pump stations will pump water to the new filters and pump effluent from the contact tank to reservoir R5-2. These two pump stations are crucial to maximizing the capacity of this plant expansion, so both pump stations will be designed to provide the capacity that is currently needed and have room to be expanded in the future up to the maximum future capacity.

INFLUENT PUMP STATION

The Influent Pump Station will be a canned, vertical turbine pump station located between the new Filter Building and the new retaining wall. We will approach the design of this pump station so it meets current flow requirements while allowing for future expansion and future increase in plant capacity with minimal disruption to the pump station demonstrated in **Figure 3.2**.

As we progress the design, we will evaluate the pump station performance at current and future conditions, which will require evaluating the pump selections at current and anticipated future conditions. We will pay attention to any impact that future expansion may have on the performance of the pumps that are currently installed. For example, the total head loss may be greater due to increased maximum flow into and out of the pipes.

Figure 3.2: Influent & Effluent Pump Capacity

Phase	Influent PS Capacity, Duty + Standby (MGD)	Effluent PS Capacity, Duty + Standby (MGD)	Number of Pumps at each pump station	New Plant Capacity in This Phase (MGD)
Phase 1 (current project)	8 + 4	8.4 + 4.2	2 + 1	7.2
Phase 2 (future)	16 + 4	16.8 + 4.2	4 + 1	16.8

EFFLUENT PUMP STATION

The Effluent Pump Station receives water by gravity from the Chlorine Contact Tank and pumps to reservoir R5-2. In addition to the pumps themselves, this station provides an overflow function, so that excess water is relieved to Recovery Pond 5.

The Effluent Pump Station will also be designed to be expanded when the plant capacity is increased in the future. We will design the Effluent Pump Station by evaluating the pump so they perform well for the capacity requirements of this Project and the future capacity projections for Phase 2. The pump station will be designed to meet Hydraulic Institute standards and have the minimum footprint possible due to the low space available at the selected pump station location.

We will size the passive overflow, so the maximum overflow capacity is equal to the maximum Effluent Pump Station flow. In the event that this pump station is not in operation, the overflow will allow for 100% flow through the pump station.

MODIFIED PUMP STATIONS

Four pump stations will be modified, and each has specific design requirements and considerations unique to that pump station. These modified pump stations consist of the UV recovery pump station, the GAC pump station, the Ponds 1-4 pump station and modifications to these ponds, and Ponds 5 and 6 pump stations and the modifications to these ponds.

1. UV RECOVERY PUMP STATION

The UV recovery pumps will be replaced, so the total maximum capacity of the pump station equals the new maximum capacity of the treatment plant. The purpose of this pump station is to return non-compliant water to the influent blending ponds. The pump station will maintain the current process flow procedure: when water is determined to be non-compliant, valves dump water downstream of the UV Reactors into the existing wetwell of the UV pump station. The UV recovery pumps then convey water through a pipeline that can be directed to either or both Influent Blending Ponds 1 and 2.

The DCR indicates that the butterfly valve on the discharge is to modulate to maintain the pump discharge pressure at 13 psi (30 feet). This appears to be higher than necessary by about 15 feet, so we propose maintaining

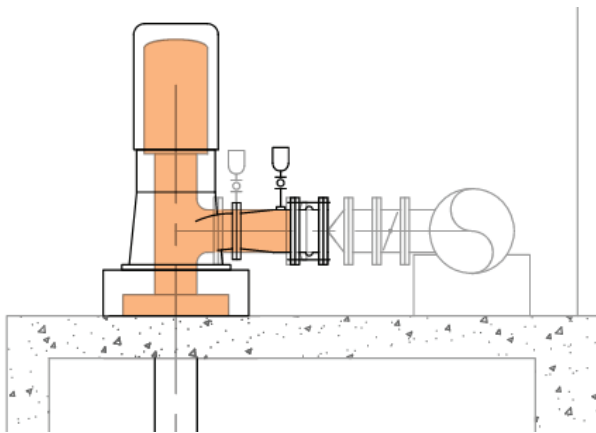

We confirmed the fit of the new UV Recovery pumps in the existing pump station location

a pressure closer to 6.5 psi, which will improve the performance and longevity of the butterfly valve used to modulate the pressure. Additionally, the static lift of the existing conditions appears to be about 18 feet from the lowest allowable pumping level to the pump discharge elevation, which pushes the total dynamic head requirement higher than indicated in the DCR to 34-feet, which will require a larger impeller trim and motor. The asset register indicates the pumps should be Peerless 16HXB, and Appendix G of the DCR indicates a 17SPM. Our proposed UV recovery pump is the same Flowserve 17 SPM pump identified in the Appendix. However, we will equip this pump with a 50 HP motor instead of the 40HP motor indicated in the DCR to accommodate the anticipated higher total dynamic head requirements.

We will design the new pump station by confirming the existing dimensions of the pump support pad, discharge header, and wetwell depth. The new pumps will be installed with new 12-inch discharge pipe and fittings, and the design will reuse the existing 12-inch check valve and 2-inch air relief valve. The existing 24-inch header will remain.

Additionally, we will modify the header so that instead of leaving the building through the northeast wall of the Filter Building, the discharge header continues straight out the southeast side of the building and is routed underground to the tie in point where the flow splits to the two blending ponds. As we design this pipe segment, we will coordinate this pipe routing with the new retaining wall and the vehicle access route along the northeast side of the Filter Building.

2. GAC PUMP STATION

We will replace the existing GAC pumps in the lower level of the existing Filter Building with new pumps, valves, and associated piping. The existing pumps have a capacity of 2100 gpm each (per the Phase III

Expansion project). The new pumps will be 3,500 gpm each, for a total flow of 7,000 gpm (10 MGD). Each of the GAC vessels can treat up to 1 MGD, so all ten GAC vessels will be able to be in operation at the same time.

Our approach to designing this pump station will be to start with the flow requirement described above and then determine the total dynamic head these pumps will see at that design flow rate. The new pumps will increase the design flow rate at each of these pumps by over 50%, so we will carefully review the existing piping and the pump selection to ensure the new

installation complies with the recommendations of Hydraulic Institute 9.6.6. We will carefully look at the suction piping and design, so the new suction piping uses the existing 12-inch pipe penetrations and complies with hydraulic institute recommendations for suction piping.



The new pumps will require modification to the existing pump equipment pads, the suction and discharge valves, and piping. The new pumps will be equipped with variable speed drives to modulate flow through the GAC as the flow through the plant increases and decreases.

3 AND 4 PUMP STATIONS AT RECOVERY PONDS 1-4 AND RECOVERY PONDS 5 AND 6

We will replace the existing decant pumps at Recovery Ponds 1-4 and at Recovery Ponds 5 and 6. Water from both of these ponds will be directed to one of three locations, depending on water quality and plant operation requirements. Our approach will be to evaluate the pumping requirements for all three of the destinations: Pretreatment, the DAF Equalization tank, or Sludge Ponds. Each of these three conditions will have separate total dynamic head conditions, so we will make the final pump selection based on that

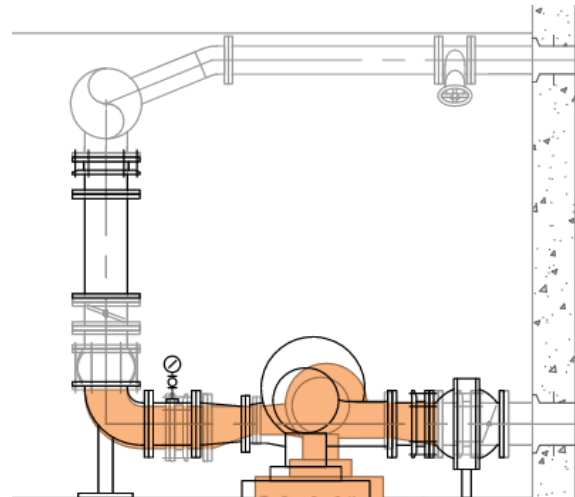

We confirmed the fit of the new GAC pumps in the existing pump station location

evaluation so that all modes of operation can be performed by the selected pumps.

4.4.2 HYDRAULIC CAPACITY

The addition of the new Trident filters will add an additional 7.2 MGD of treatment capacity to the existing 14.4 MGD treatment capacity. That additional capacity will be routed through the new Influent Pump Station, new filters, and the new Effluent Pump Station. Each of these systems will be designed for this current capacity of 7.2 MGD and will also be designed for future expansion to add an additional 9.6 MGD of treatment capacity. The new treatment loop and the existing treatment loop will pass through the UV Reactors and the Chlorine Contact Tank. The UV Reactors have a total capacity of 30.4 MGD, which is enough to handle a future increase in capacity. The Chlorine Contact Tank currently operates as a treated water reservoir. It has a sufficient volume for the additional capacity that will be added with this Project and the future capacity.

The UV recovery pump station and the GAC pump station will be upgraded with this Project to be adequately sized for the new

capacity of the plant. In order to minimize pumping costs, most of the pumps will be equipped with variable speed drives. This will allow pumps to reduce the electrical power they draw as the flow through the plant decreases below the maximum flow. Pumps will be chosen with the best efficiency at their average operating point so that the pump operates at higher efficiencies more frequently.

Figure 3.3 indicates what the hydraulic capacity of the facility will be after this Project and after future projected expansions. It also illustrates how the various elements are sized to ensure the plant can operate at the maximum hydraulic capacity of the filtration treatment.

4.4.3 NON-PROCESS DESIGN AND AUXILIARY FACILITIES

CONSTRUCTION SEQUENCING

Initial site mobilization will have trailers for construction, owner space, and meeting space located between the new DAF unit site and the existing chemical building. This will allow the trailers to remain for the entire duration of the Project. Construction parking

will be along Riverside Avenue. A temporary badge access point will be installed at the existing fence to control access to the site. Surveillance cameras will be installed to document the movement of workers. It is anticipated the construction Project Manager and Superintendent will have access to the existing gate along Riverside Avenue to allow access for material and equipment deliveries. There is ample room at the north fence line for the storage of materials. We do not anticipate any large spoil piles; major excavation material will be loaded and disposed of off-site. Spoil material related to underground utilities will be small enough to stay within the boundaries of the work. During the construction of work on the east side of the existing building, an access road will be put in place at the new Effluent Pump Station to allow access for the operators to the rest of the site. Once the retaining wall is complete, this access road will be restored. Stormwater management will follow the requirement of the approved SWPPP Plan and PCL's Best Management Practices (BMPs) as part of our HSE Plan.

See our detailed site logistics plan for the Roemer Water Filtration Facility Project in **Appendix B**.

Figure 3.3: Plant Hydraulic Capacity

Equipment	New Capacity	Existing Capacity to Remain	Total Capacity After Project Completion	Additional Future Capacity
Clarifier/Filters	7.2 MGD	14.4 MGD	21.6 MGD	9.6 MGD
Influent Pumps	7.2 MGD	14.4 MGD	21.6 MGD	9.6 MGD
Effluent Pumps	7.2 MGD	14.4 MGD	21.6 MGD	9.6 MGD
UV Reactors	30.4 MGD	–	30.4 MGD	0
UV Recover PS	21.6 MGD	–	21.6 MGD	0
GAC Pump Station	10.0 MGD	–	10 MGD	0
DAF	2.0 MGD	–	2.0 MGD	0

Our overall approach to the Civil and Pipeline design will be to collect information on existing conditions and methodically lay out the facilities in a way that maximizes value and constructability. The grading and paving design will prioritize site accessibility while also accomplishing stormwater runoff management. Underground utility design will prioritize functional operation of new utilities, protection of existing utilities in place, and designing for future maintenance access. For the Roemer WFF design, yard piping design has been well established by the DCR. The yard piping design will be refined via onsite potholing explorations with backfill requirements dictated by site geotechnical exploration findings. New yard piping will be located outside of the zone of influence of new and existing structures where possible. The treated effluent pipeline alignment will be offset from the centerline of West Via Bella Drive to maintain adequate separation from the sewer that runs on the northern side of the road. Offsetting the pipeline alignment from the centerline also allows for public access to be maintained along the north side of the road, see **Figure 3.4** for a graphic representation of where construction

equipment, safety equipment, and access will be staged during construction.

Modifications to existing pipelines and other facilities will be designed and constructed to minimize service interruptions and maximize operator and owner access to the facilities for concurrent operation. Existing facilities to be abandoned will be thoroughly assessed to optimize constructability. It is anticipated that to-be-abandoned facilities will be filled with controlled low-strength material (CLSM).

The grading and surface drainage design for the Roemer WFF site is less defined by the DCR, so this will be developed by avoiding areas of ponding, maintaining drivable slopes in paved areas, directing runoff away from new and existing structures (above and below grade), and minimizing new storm drain piping. Stantec proposes to incorporate onsite management of stormwater where feasible, including the use of drywells, infiltration trenches, and other best management practices (BMPs). The expectations for pavement design are well established, with new pavement areas and replacement-of-existing pavement areas being delineated in

Figure 3.4: Anticipated Construction on W Via Bello Dr.
(utility locations to be confirmed by potholing)

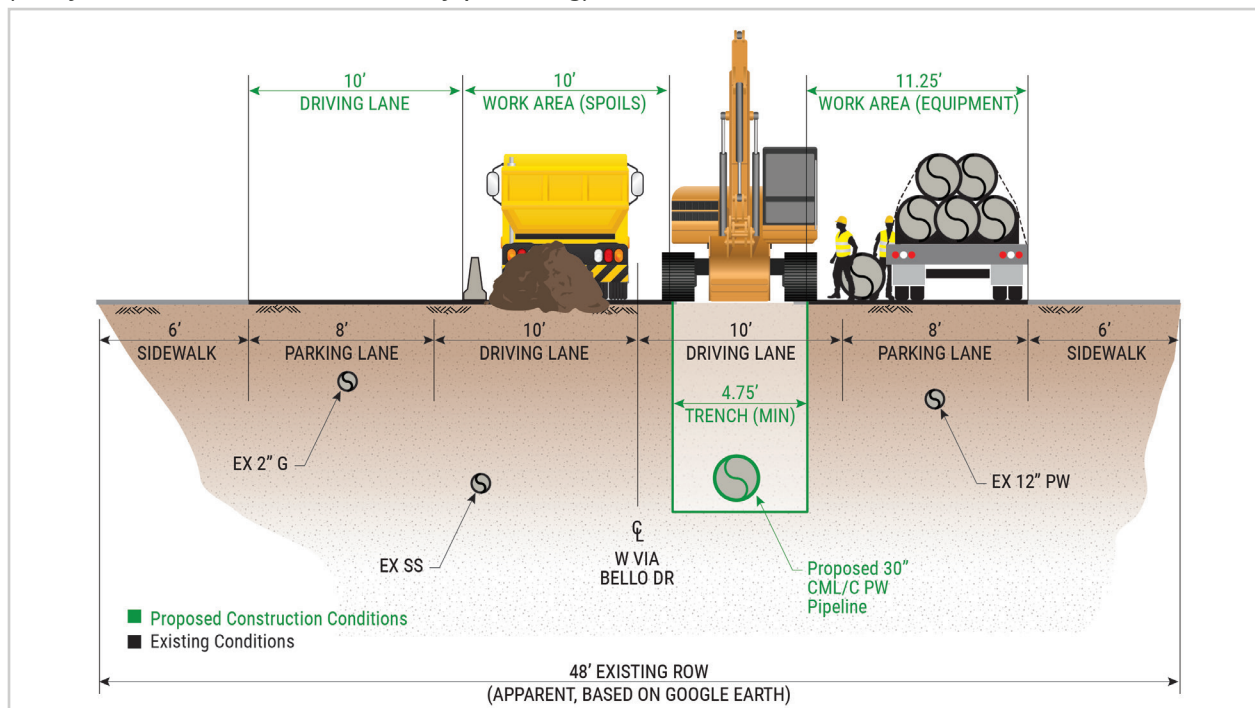

the DCR. Pavement design sections will be dictated by geotechnical findings. Roadway widths and turning radii will be optimized using AutoTurn software to ensure the necessary vehicles, including emergency service vehicles, can access the facilities safely and reliably. We understand the DCR documents are based on historical survey information, so we propose performing our own detailed field surveys to confirm site conditions and inform the grading, paving, and surface drainage design.

NEW FILTER BUILDING

The new Filter Building will be a pre-engineered metal building located next to the existing Filter Building. The new Filter Building will be designed for continuity of appearance between the existing building and the new building and take into consideration the unique structural and code requirements involved with installing this new building adjacent to the existing building.

Our preliminary structural analysis indicates that a minimum structural gap between the buildings of 10-inches is required per CBC and ASCE7-16. This gap allows for separate structural movement in a seismic event. This gap will be made up of non-structural flashing between the new building and the gutter of the existing building.

We performed a code analysis of the combined existing and new buildings, which indicates that the overall footprint of the existing and new buildings exceeds the maximum footprint allowed by the California Building Code. The cause of the restriction is the Sodium Hypochlorite stored in the chemical area of the existing Filter Building, which triggers an H-4 classification for the buildings when more than 500 gallons are present. This limits the overall footprint to 30,875 SF, which is 700 SF less than the footprint indicated in the Design Criteria Report.

We will continue to investigate alternative methods to keep the buildings at the same overall footprint indicated in the Design Criteria Report, but if an alternative is not found, then the new building will be shortened by 12-feet to comply with the California Building Code. We studied the effect that shortening the building will have on the future treatment expansion to confirm that future expansion will still be possible. Refer to **Figure 3.5** on the following page for details of the proposed arrangement within a shortened building and some of the other considerations we will make while designing and installing this building.

We anticipate that some cross bracing requirements in both the existing and new buildings may limit some of the access between the sides of the building, but we will work with you and the building manufacturer to maximize the open space and access way between the new and existing buildings. Our approach will be to work closely with the pre-engineered metal building supplier to ensure the design considerations described above are fully accounted for in the building's design, and the other requirements described in the DCR are fully incorporated into the building design.

We reviewed the seismic design parameters indicated on the Structural Drawings in the DCR and assumed that some modifications will be required. Our proposal is based on the following design parameters, based on CBC 2019 (ASCE 7-16), and the U.S. seismic map information for the project location.

Proposed Structural Design Criteria

- Wind Speed: 100 MPH
- Wind Exposure: C
- $S_s = 2.206$
- $S_1 = 0.861$



EXHIBIT 7: FILTER BUILDING DESIGN CONSIDERATIONS

ROEMER WATER FILTRATION FACILITY 2022 UPGRADES AND EXPANSION

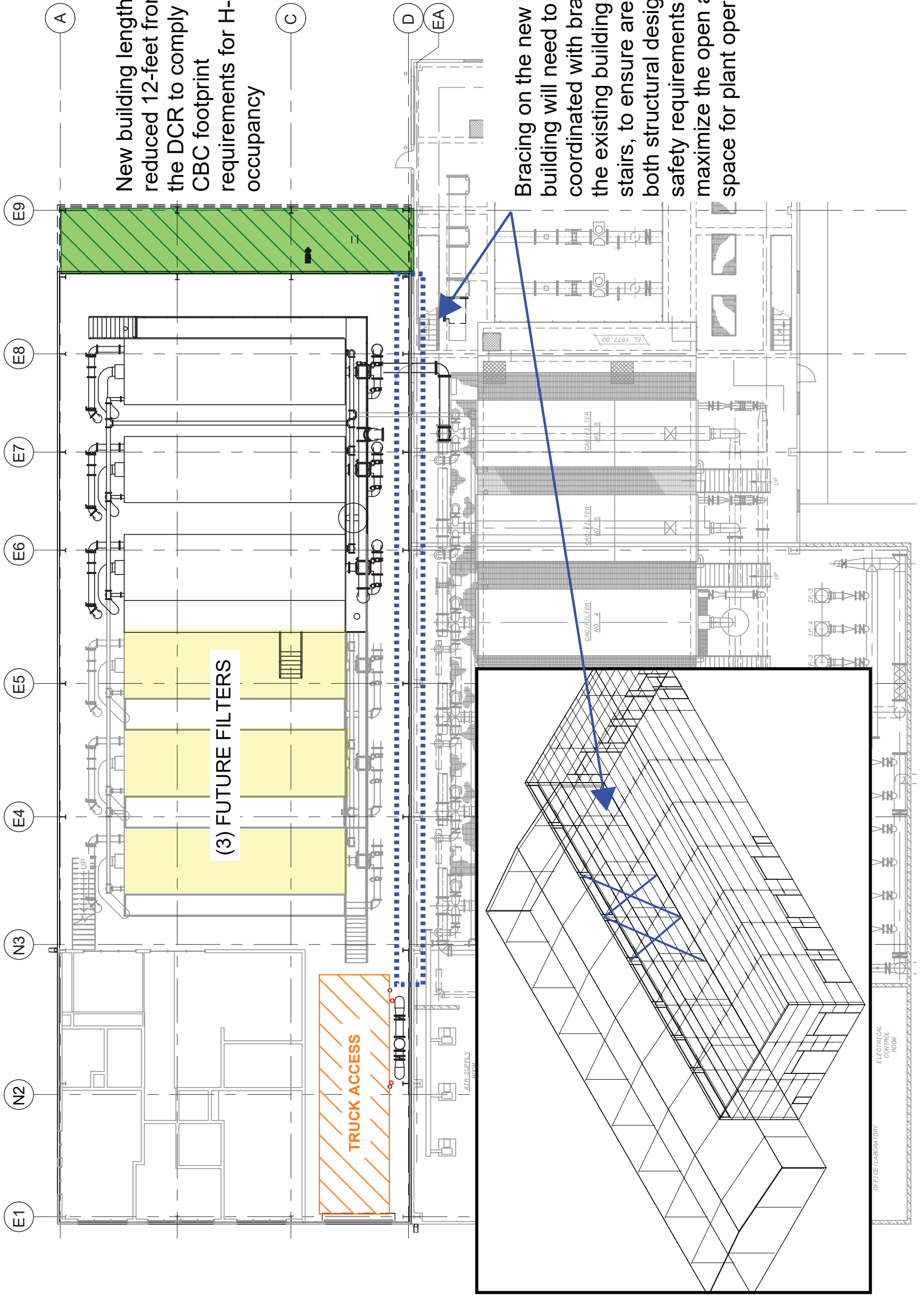

New building length is reduced 12-feet from the DCR to comply with the CBC footprint requirements for H-4 occupancy

(3) FUTURE FILTERS

TRUCK ACCESS

Bracing on the new metal building will need to be coordinated with bracing on the existing building, existing stairs, to ensure area meets both structural design, OSHA safety requirements and maximize the open area space for plant operations.

POWER SUPPLY & ELECTRICAL EQUIPMENT

Our approach to the electrical design will involve site data collection of the existing Main Service Center (MSC-C) and (MSC) switchboards, transformers, motor control centers (MCC), power panels nameplate data, and connected loads. We will compare this data against record-drawings, DCR drawings, and the modifications to the DCR in this proposal to make sure we have the latest electrical load data. We will also measure and confirm the existing electrical rooms and yard layouts to confirm working space and equipment clearances meet codes and SCE requirements. We observed that the DCR shows the 1500kW generator placed over the existing 30-inch effluent piping, which is not ideal for maintenance or future modifications to the piping. We will investigate alternate locations for this generator. We will also design for harmonic mitigation to address the effects of the significant number of new variable frequency drives (VFDs) added to the facility.



Once we have all the existing and new loads tabulated, we will coordinate with SCE to submit a service application for the plant modifications. This will determine if SCE needs to upgrade its existing service switch and transformer. The load tabulation will also be used to confirm the existing switchboard's capacity and confirm the size of the emergency

MSC-C Load Analysis

Current Electrical Loads:	1,527 Amps
Anticipated New Loads:	1,299 Amps
Total Loads After Project:	2,826 Amps
Maximum Load of MSC-C:	3,000 Amps

Conclusion, no upgrade to MSC-C is required.

standby generator and automatic transfer switch. The MCCs will be sized, and elevations confirmed with major manufacturers and system integrators to incorporate Toshiba VFDs. We will match existing site and building lighting systems utilizing LED light fixtures. The lighting calculations and lighting controls will be designed to meet current Title 24 requirements. Surge protection will be incorporated into service and distribution panels.

We intend to follow the DCR and will incorporate existing plant-preferred equipment and preferences where possible.

INSTRUMENTATION & CONTROLS

While the treatment upgrades cover portions of the facility, the Supervisory Controls and Data Acquisition (SCADA) upgrades extend plant-wide. The existing Roemer WFF SCADA system is built on the AVEVA (formerly Wonderware) Intouch HMI platform, and a combination of Tesco and Allen-Bradley PLCs distributed across the facility networked over fiber. The main servers are located in the District Headquarter administration building's SCADA control room, and they communicate with the Roemer Facility via radio. The Roemer Facility employs remote thin clients running Wonderware Runtime Application.

The instrumentation and control system will be designed in accordance with the industry codes while complying with all applicable project standards described in the Design Criteria Report. Design considerations will be made that reduce the long-term cost of ownership both in terms of energy use and equipment maintenance while improving the overall operability and maintenance of the facilities. The facilities will be designed with a high level of automation with remote monitoring and control. The control system will be automated to achieve maximum efficiency without undue complexity for operations or maintenance personnel.

The proposed architecture will establish a high availability (HA) SCADA system providing redundancy and disaster recovery measures. Three converged rack servers with HA virtualization will be deployed at the Roemer WFF to eliminate reliance on the remote servers at the District Headquarter administration building. Due to the proprietary nature of the existing Tesco PLCs, the control system upgrade will replace all legacy Tesco panels. The main filter control panel will be upgraded to the ControlLogix Line or processors with considerations for redundancy. We recommend configuring the distributed PLCs in a ring configuration to best leverage the existing fiber infrastructure.

the system. The historian will receive data from both the new and existing equipment and will be capable of performing data analysis and automatic report generation with pre-arranged process data displayed. All plant I/O will be displayed on the plant HMI control screens and panel OITs with all analog data (as well as alarms and status points) historically collected, recorded, and trended. Control screens will be consistent in presentation, quality, color usage, symbol usage, font usage, and navigation options in accordance with the existing HMI standard. Additionally, we propose that all new starters will be networked over Ethernet/IP to their respective PLC, providing access to the multitude of available diagnostics and monitoring data points. However, critical control parameters will be hardwired to maintain the existing system resiliency.

All new process control systems will tie into the facility historian server, which serves as the master repository of all data collected by

Figure 3.6: Key Network Segmentation Topology

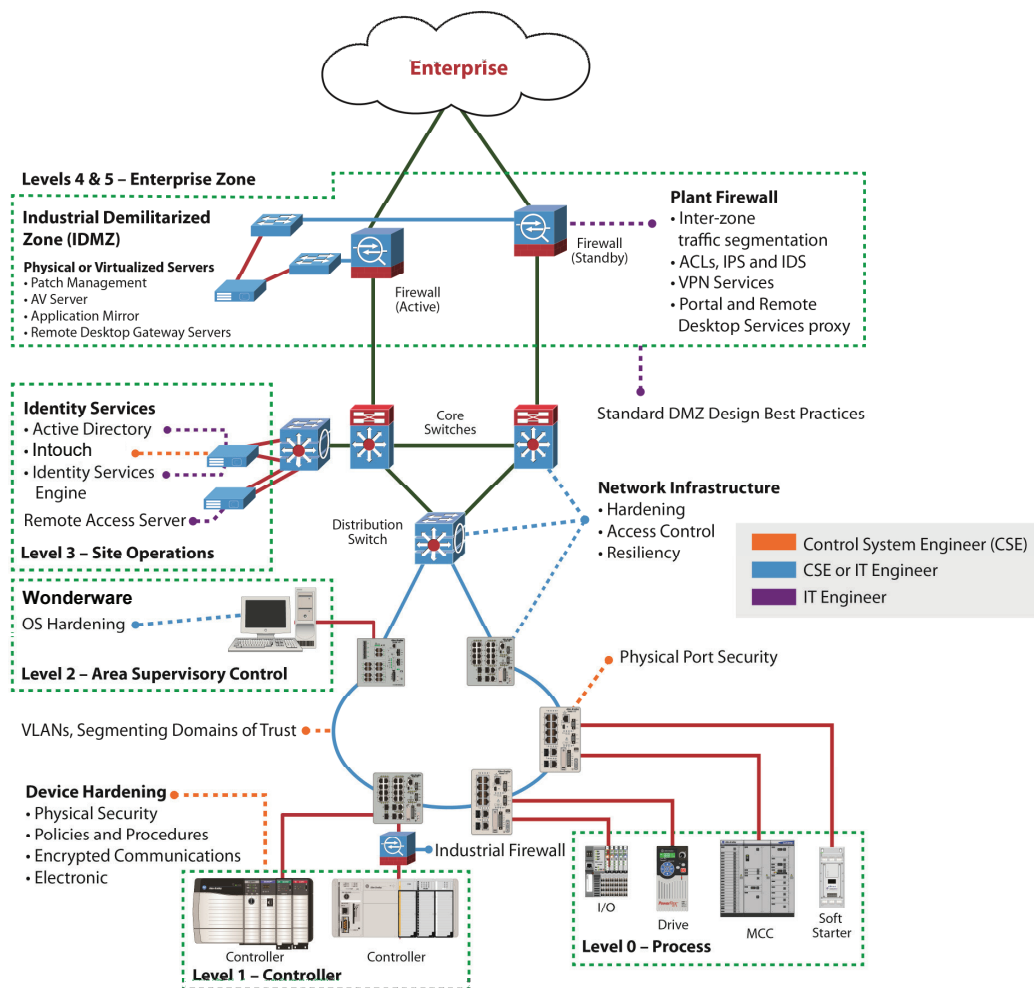

4.4.4 INNOVATION & DESIGN OPTIMIZATION

As we developed this proposal, we identified key elements that required additional design progression and analysis. We evaluated options and alternatives and progressed the design of certain elements to ensure that we have a thorough understanding of the design requirements for this Facility. This section discusses those elements for which we discovered ways to innovate or optimize the design.

DAF VS. GRAVITY THICKENERS

We evaluated alternatives to DAF for solids removal. In particular, our immediate thought was that gravity thickeners appeared to be a good alternative that would use fewer moving parts. Gravity thickeners are typically sized with a maximum surface loading rate of 0.15 gpm/SF, so each gravity thickener would need to be 80-feet in diameter. Three of these thickeners would be required to replace the three DAF units, which severely increases the footprint requirements and the construction costs. The gravity units would be this large because the filter washwater and clarification/sedimentation solids are almixed together, so this becomes a lot of water with low solids content.

The DAF units have much higher maximum surface loading rates, so they can deal with the water flowrate more efficiently given the configuration in this proposal. In order to get the gravity thickeners to a reasonable size, we would need to remove the filter backwash from the thickener influent. However, this would reduce the functionality of the plant because backwash water would not be able to be treated to a level where it meets the Filter Backwash Rule that requires the NTU in the water to be less than 2-inches order to return the water to the head of the plant.

Conclusion: After performing this analysis, we agree that the DAF solution looks like the appropriate solution for this application.

Figure 3.7: Gravity Thickener arrangement study

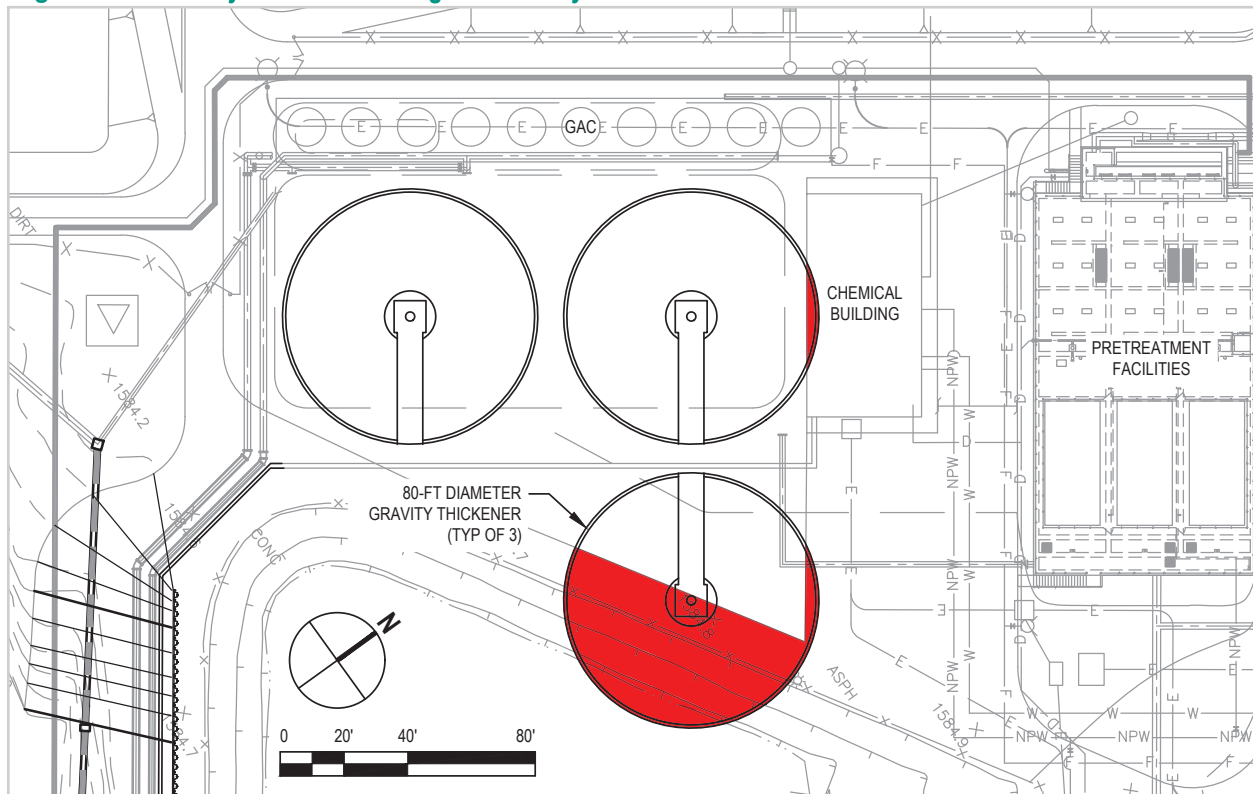

DAF REDUNDANCY AND INNOVATIONS

Our proposed layout of the Equalization Basin, DAF Influent Pumps, and DAF units uses a dedicated pipe from each DAF Influent Pump to feed one individual DAF unit. This will allow the flow through each of the DAF units to be individually controlled to ensure equal loading of the DAF units. This layout will include interconnecting piping and valving between each of the feeds so that one of the other DAF Influent Pumps can act as an operational backup for the supply to each DAF unit. Any combination of two DAF units can be in service with any combination of two DAF Influent Pumps. Our layout will also include space and a blind connection for an additional future DAF Influent pump. A future fourth pump will allow all three DAF units to be in service with one additional DAF Influent Pump on standby.

The DCR identifies the DAF Influent Pumps as submersible pumps with a design condition of 700 gpm @ 50 feet. One of the design challenges for these pumps is the total dynamic head requirement will be much lower than 50 feet because the total dynamic head will consist of the difference in head between the equalization tank and the DAF units, and the dynamic losses in the DAF Influent piping.

Conclusion: Our proposed solution is to install self-priming wastewater pumps in a shallow dry pit adjacent to the equalization tank. The pumps will be more easily accessible, are better suited for the relatively high-flow/low-head operating condition of these pumps, and have robust solids handling ability.



Design
Enhancement

Figure 3.8: Process Flow Diagram of Proposed DAF System with Multiple Feeds that Allow Operational Flexibility

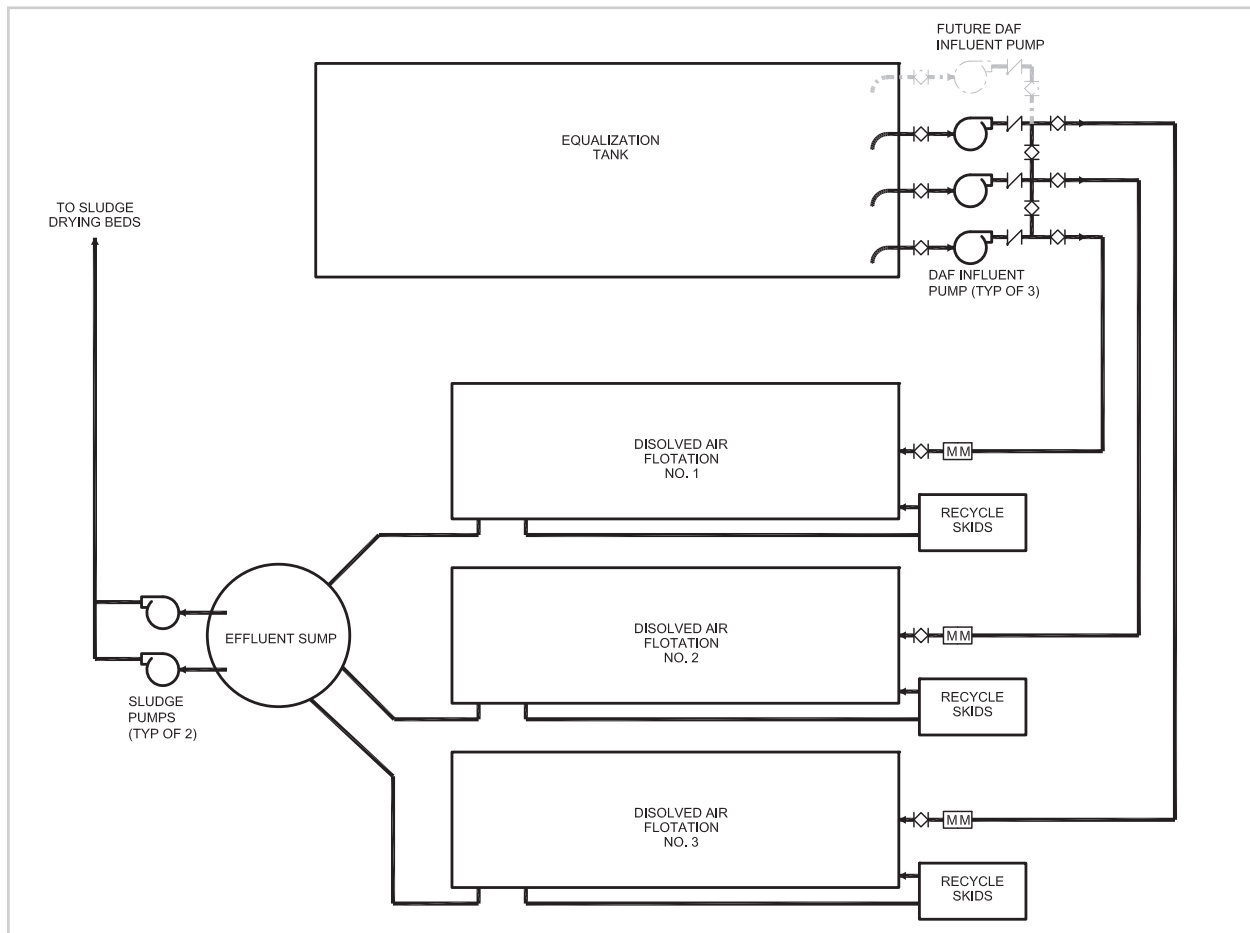

DAF REDUNDANCY AND INNOVATIONS CONTINUED

An operational challenge we anticipate is solids settlement in the Equalization Basin. It is hard to know in advance if this will be a limiting factor, but we plan to address this from two angles:

1. **Analyze the required size.** We have assumed the requirements in the DCR, but if the size of the Equalization Tank can be reduced, that will reduce the amount of time solids have to settle. We will evaluate this by closely looking at the average and maximum volumes of water sent to the Equalization Tank based on current plant operation, extrapolating for the increased plant capacity from this project, and

impacts of future plant expansion.

» **Conclusion:** We may be able to make the equalization tank smaller and improve the solids retention in the water by doing so.

2. **Our pump and piping layout allows the option to add a recirculation line to the DAF Influent piping.** In this way, the standby pump can be used to recirculate water and promote mixing.

» **Conclusion:** The standby pump would be used in this capacity if a recirculation system were added in the future.

FILTER LAYOUT INNOVATIONS

Instead of installing a sump manhole at each Trident Filter, we will install a single sump manhole to collect the filter-to-waste discharge. The sump is required to provide an airgap that protects against a cross-connection on the filter-to-waste side of the filter but is not required for the backwash waste connection. WesTech has confirmed the backwash waste connection can be hard piped directly to a properly sized drain. We reviewed the maximum backwash rate and sized the drain to handle this flowrate

by gravity without exceeding 50% fill in the drain pipe.

Conclusion: This improvement will make future expansion easier because additional sump manholes will not be required for future filters. The future filter-to-waste pipeline will tie into the filter-to-waste header that will be installed with this project, and the future backwash waste connections will tie directly into the drain header.



Design
Enhancement

Figure 3.9: Single Sump Configuration Simplifies Construction and Reduces Cost

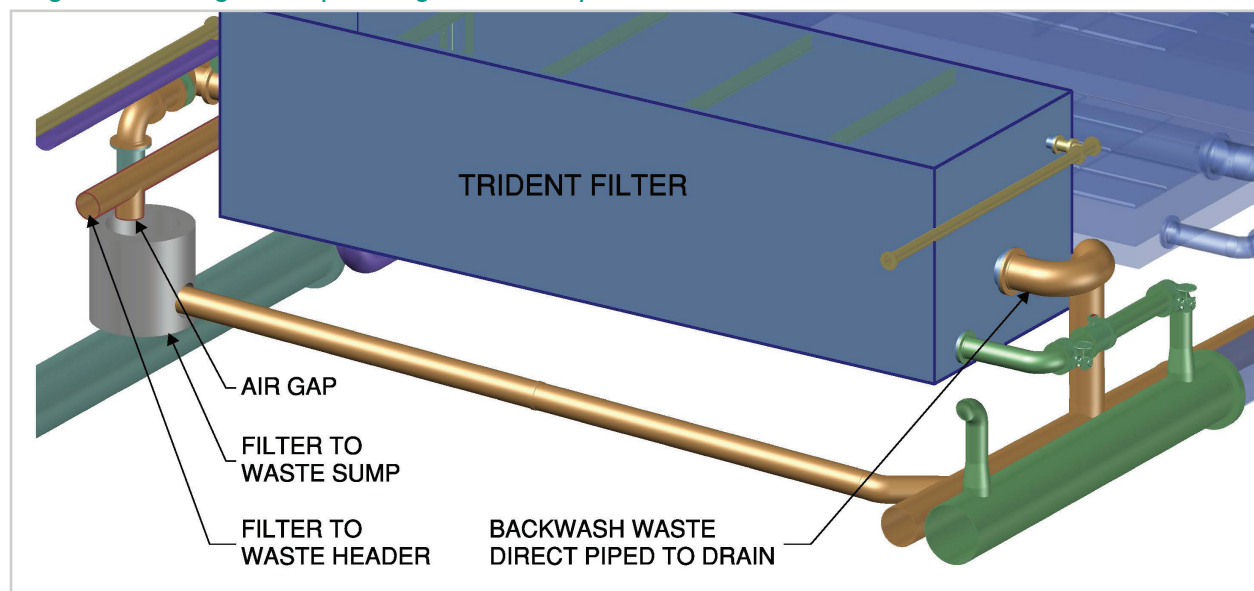

FILTER BUILDING INNOVATIONS

We will design the new Filter Building as a seismically separate structure from the existing Filter Building. This approach allows us to leave the existing Filter Building as is with only minor modifications, with no structural re-evaluation or redesign required. The new Filter Building will be designed with the code-required separation

between structural elements, so that the existing and new buildings will not interact with each other in a seismic event. The interface between the two buildings will be accomplished with non-structural flashing and other architectural elements to create visual continuity between the two buildings.

Figure 3.10: Building Codes Require Seismic Gap

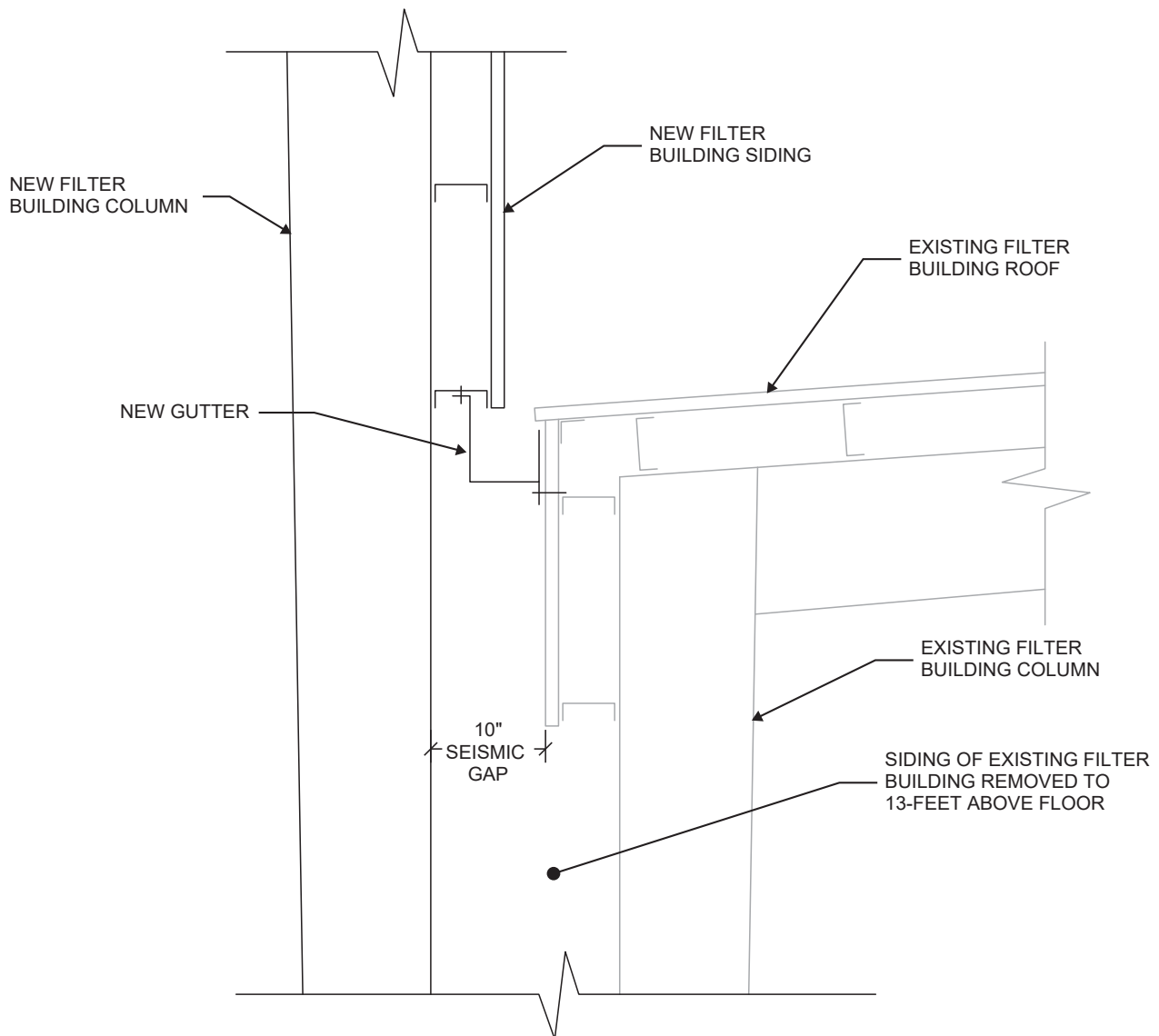

AIR PIPING INNOVATIONS

The DCR requires replacement of the existing air piping as well as the new air piping for the new filters. These headers are 8" size, except that we have increased the size of the header leaving the Air Supply Room to 10", and we plan to include an 8" blind flange for future expansion that will allow the air to be routed as a pipe loop.

A pipe loop will provide added flexibility, redundancy, and reliability to the air supply. If one portion of the air supply piping has to be taken out of service in the future, the equipment downstream of that point won't be stranded. This will also allow multiple air paths, reducing losses within the piping and allowing for the added flexibility to run multiple air scour cycles simultaneously.

The District may not be able to make full use of the enhancements from a pipe loop

arrangement now, but there is the potential for much larger value when the plant is further expanded in the future. Our base bid includes the increased header size and additional outlet that will allow for that future enhancement to be easily accommodated without the need to replace any of the piping that will be installed with this project.

Figure 3.11 shows the preliminary design for the air piping system, with the conceptual design for a future addition to enhance the air piping into a loop system.

Conclusion: Adding the ability to expand the air piping into a pipe loop configuration provides future benefits to the redundancy and reliability of the air system.



Figure 3.11: Preliminary Air Piping Design with Allowances for Future Enhancement

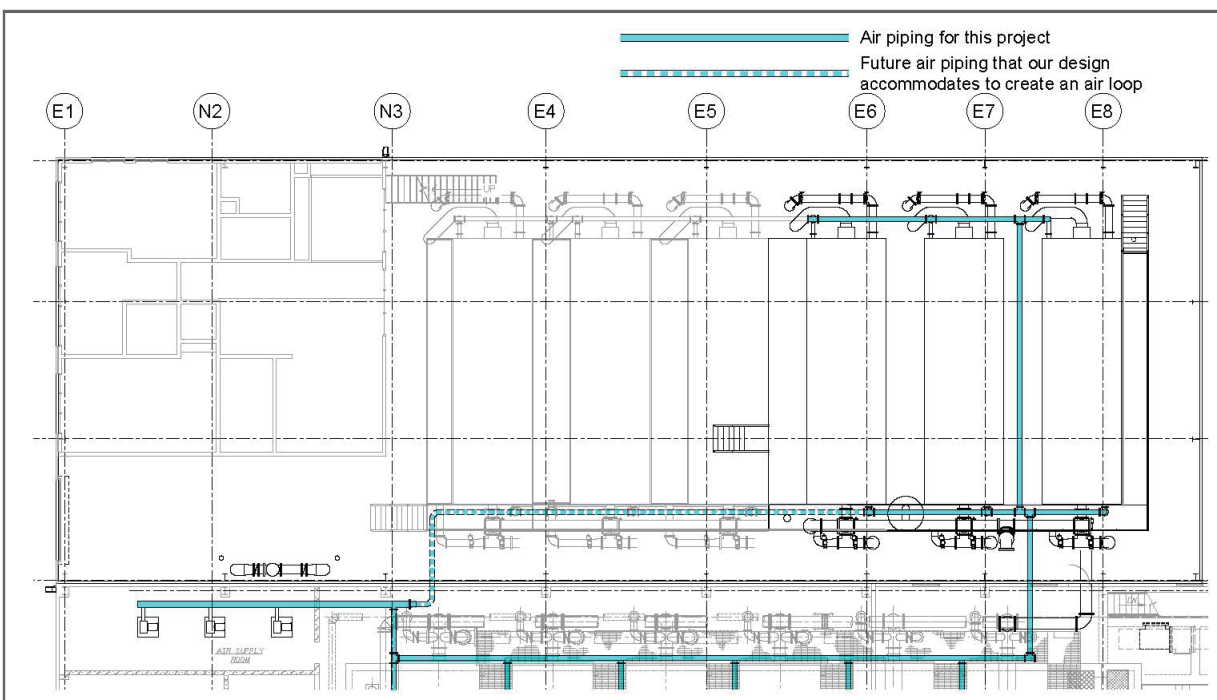

GAC PUMPS

The existing condition presents a design challenge for these new pumps. The existing wall penetrations are 12-inches, and at the design flow rate of 3,500 gpm, the velocity through the suction piping is close to 10 feet/second, which exceeds hydraulic institute recommendations for suction piping. However, higher flow rates are allowed for the portion of

straight pipe that is the same diameter as the pump suction.

Conclusion: By selecting a new pump with a 12-inch inlet and installing full port ball valves for isolation (instead of a butterfly valve), the new installation will comply with the recommendations in Hydraulic Institute 9.6.6.



Design
Enhancement

Figure 3.12: GAC Pump Layout Meets Hydraulic Institute Recommendations

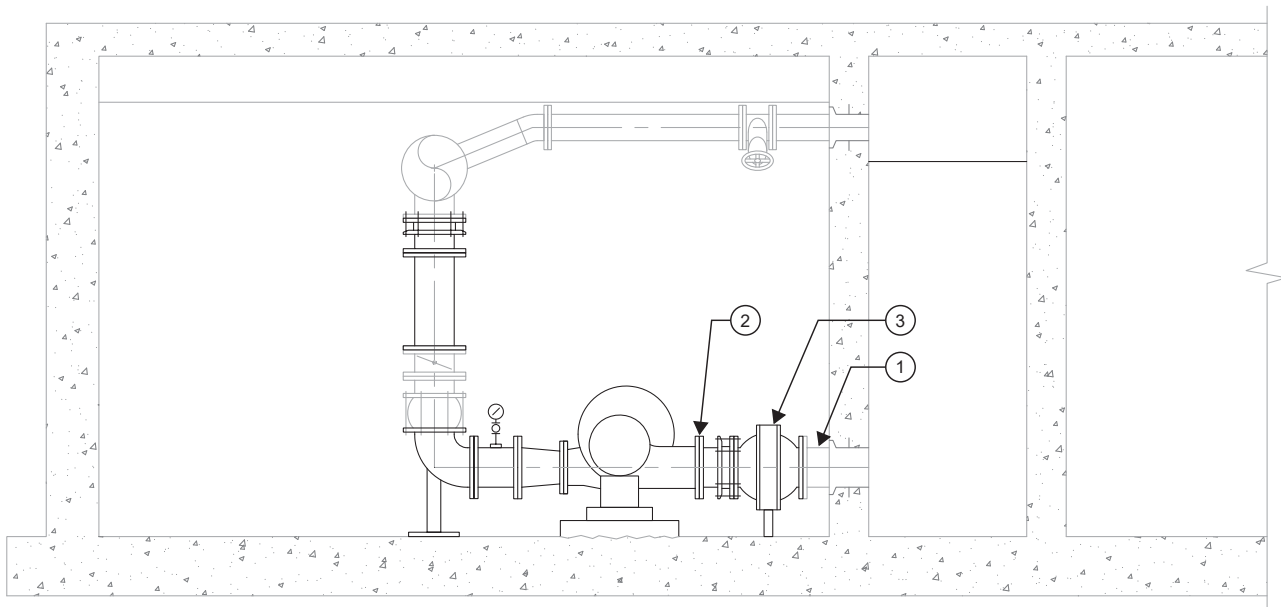

- ① HI 9.6.6.3.1 recommends that suction velocities be below 8 ft/sec, but higher velocities are allowed in straight pipe the same size as the pump suction.
- ② The selected pumps will have a 12" suction to maintain a straight run of suction piping with no change in diameter to comply with Hydraulic Institute recommendations.
- ③ Full port ball valves will replace the butterfly valves to eliminate obstructions in the suction line.

DESIGN SEQUENCING

In order to construct this plant expansion, we need to have a design in place. Therefore, our design schedule will support the procurement and construction of the plant, and we intend to develop the design in separate packages, so the design for each element is complete before construction begins.

In general, the design will progress in the same order as construction, beginning with underground piping, ductbanks, foundations, and below-ground structures. This will continue with above-ground structures, process mechanical, and the lower half of P&IDs. The architectural and electrical drawings will follow, and then the building mechanical and upper

half of the P&IDs will be complete. Another benefit to developing and submitting the design as a number of smaller design packages is that the review process for the District will be easier, quicker, and more collaborative.

Conclusion: One of the unique challenges of this project is the short overall project duration, which includes design, procurement, construction, and startup of the facilities. By dividing the design into smaller packages, our design schedule will help us to meet this goal.



CASE STUDY

The PCL design-build team for the Miami-Dade WWTP Oxygen Production Facility proposed two design packages:

1. Foundation Design
2. Building Design

The Master Permit allowed construction to begin on the foundations prior to the completion of the overall project. PCL was able to proceed with foundation construction while the design team completed and finalized the building design package.

In the case of the Oxygen Production Facility project, breaking up the design packages with the permitting Agency's involvement resulted in reducing the overall construction project schedule by three months.



PART IV ▶
**CONSTRUCTION
& START-UP
PROCESS**



PART IV

CONSTRUCTION & START-UP PROCESS

4.5.1 CONSTRUCTION PLANNING AND SEQUENCING

CONSTRUCTION PLAN AND SEQUENCING

Please see **4.5.3 Design-Build Schedule** for our detailed construction plan. A P6 schedule is provided in **Appendix C**.

WORK BREAKDOWN STRUCTURE/RESOURCE LIMITATIONS

Review, approval, and delivery of materials are critical to the completion of the project. We are comfortable the facility size and project scope are not large enough to warrant labor or equipment concerns. Self-perform crew sizes do not exceed two crews with a maximum make-up of six men. Activities have been resource loaded and adjusted to maintain project flow in regards to labor.

The underground piping crew will be able to address the critical path items and schedule the remaining work with plant operations to coordinate road closures and other construction work. The weekly project meeting and three-week look-ahead schedule is the proper management tool to communicate this work.

This project's scope has a significant amount of subcontracted work, but the scopes are not large enough to warrant any labor or scheduling concerns. A majority of the subcontractors selected for this project have worked with PCL on previous projects and

have good working relationships. Schedule adherence and understanding of the design-build process are key components to subcontractor selection and, ultimately, subcontractor participation in coordination and performance for this project.

Long lead equipment has been identified in the project schedule submitted with the proposal. We will utilize the early works package to advance the design and release the equipment to meet the project schedule.

Experience with Procurement and Delivery of Long Lead Materials

A procurement log will be used to prioritize materials and equipment and be able to determine the critical point when something is needed to be released into fabrication. This log will also be used to determine what design information needs to be developed in order to release the materials and equipment. This log will be part of the weekly meetings and will be a critical piece in the pull-planning sessions to further develop the design-build schedule.

In order to meet the project schedule, we have identified key fabricated material packages that are required for early release:

- GAC Reroute Piping
- Filter Bldg Underground Piping
- Sheetpile Shoring Wall
- Effluent PS Reinforcement
- DAF EQ Tank Reinforcement

70%

PCL typically self-performs up to 70% of the direct scope of work on water filtration facility projects, regardless of delivery method.

EFFICIENT SCHEDULING.

We leverage trade-specific experience to create accurate, efficient, and dependable schedules.



FASTER TEAM COALITION.

We require less time to complete subcontractor selection and onboarding.

FLEXIBILITY. We have the option to supplement any subcontracted workforce with in-house skilled laborers to get the project back on track in the event delays occur.



MOTIVATION. We inherently have greater incentive to complete self-perform work on time and within budget than our subcontractors do.

CONTROL. We are better able to manage the schedule by using internal forces to perform the work.



Releasing these work packages as they relate to the critical path of the project will ensure the shortest period of fabrication and delivery to the site.

Optimization of Construction Progress and Cost Through Resource Leveling

Underground piping, Concrete, and Earthwork activities have been crew-linked to level out spikes in labor needed to complete the project.

APPROACH TO SELF-PERFORMANCE

PCL will self-perform demolition, clearing of the site, excavation, grading, and backfill for the installation of underground utilities, ductbanks, and concrete structures. Self-performing this scope will assist in getting work started in the field with early works packages. Temp shoring will be self-performed during excavation for the Influent and Effluent Pump Stations. PCL intends to subcontract the street pipeline work to Reservoir 5. PCL will also self-perform the installation of all mechanical equipment, pumps, exposed piping, work required for temporary construction, as well as start-up and testing.

By self-performing a majority of the project components, we can control the project schedule, deliverables, and milestone requirements. Additionally, we believe a self-perform contractor can offer a level of quality exceeding project expectations with seasoned craftsman, a skilled workforce, a single-source of responsibility, communication, a cohesive team dedicated to successful project completion, and a world-class quality program.

When self-performing work on a project, PCL completes many of the challenging and critical path construction activities with its own skilled labor force. Much of the process equipment installation is specialty or technical work, and the risk of an improper installation, which typically will not be caught until start-up and testing, can be mitigated or eliminated by our internal skilled forces.

SUBCONTRACTOR AND SUPPLIER LIST AND PLAN

A complete subcontractor and supplier list is included in **Appendix D**. The following subcontracts will be issued due to their specialty work and labor agreements:

- Electrical and Instrumentation
- Rebar Fabrication and Installation
- Street Pipeline Work to Reservoir 5
- Permanent Shoring Wall
- CMU Retaining Wall and Veneer
- Pre-Engineered Metal Building
- Bridge Crane
- Structural Steel Framing for Interior Office Area
- Metal Decking for Office Area Mezzanine
- Wall Framing and Drywall
- HVAC
- Fire Sprinklers
- Exterior Windows, Doors, and Roll-up Doors
- Painting and Coatings
- Cabinetry, Flooring, and other Finishes
- Asphalt, Curb & Gutter Concrete Work
- Landscape and Irrigation

Subcontractor Prequalification

PCL commits to the success of our trade partners which directly translates to successful project delivery. PCL has a well-established and formalized subcontractor prequalification and selection plan. This plan encompasses the experience, bonding and insurance capabilities, corporate structure, financial information, safety history, record of quality assurance, and supplier references of each subcontractor. Our comprehensive prequalification program ensures that only the best, most qualified subcontractors perform work on our projects.

EFFECTIVE APPROACH TO SCHEDULING AND COMMUNICATION WITH SUBCONTRACTORS

Weekly coordination meetings are held on-site for PCL's construction crews and for the project subcontractors. Using the schedule as a basis, the upcoming work is carefully planned and coordinated between construction crews and subcontractors. Management staff carefully reviews the manpower requirements as well as the necessary materials and equipment for the upcoming work and ensures the availability of PCL and subcontractor staff.

The baseline schedule will be created with the entire project team including subcontractors and suppliers. By doing so, we achieve commitment from all parties which provides overall schedule control. Upon award of the Project, the entire project team will meet to develop the project activities, sequence, and relationship between them. This ensures that the schedule is realistic with correct logic, durations, and most importantly, has buy-in from the entire project team. The baseline schedule is the primary tool for coordinating subcontractors and suppliers and provides guidance for you and the team regarding issues requiring their input. Establishing a partnership and promoting transparent communication with subcontractors and your project staff is paramount throughout the schedule development, especially at the early stages, to identify and incorporate critical milestone dates for permitting, construction, start-up, commissioning, and training.

WHY PCL-STANTEC?

- > Our project management process is interactive and involves sharing information; building relationships; engaging affected parties, including WVWD's staff; establishing clear roles and responsibilities; managing risks for WVWD; supporting effective decision-making by WVWD; and creating a shared vision with WVWD to deliver a quality project.

EFFECTIVE COORDINATION WITH THE DESIGN TEAM, OE, DISTRICT AND 3RD PARTY STAKEHOLDERS

Both formal and informal communication among all members of the project team is critical to the success of the project. The free flow of information solves problems, creates opportunities, and bonds the team. Formal communication and reporting by the Contractor serves to maintain accountability, extend information to stakeholders beyond the immediate project team, and enhance your confidence in our ability to meet project objectives and deliverables. PCL offers the free use of our web-based Project Document Control program, PM4+, which allows team access to all project documents. It works as an excellent communication tool to provide access to shared information by all team members, including PCL, the owner, the engineer, subcontractors, and suppliers.

While formal communication and reporting is important, informal communication and collaboration is equally, if not more important. PCL believes that collaboration between team members cannot be isolated to occasions when the team has scheduled meetings. The purpose of routine project meetings should be to report and evaluate project progress; not to act as a forum for collaboration. True collaboration must happen behind the scenes with individuals from the engineer, contractor, and owner working together with their counterparts to advance progress of assigned tasks. For example, as PCL's superintendents develop constructability ideas for the project, those ideas will be shared immediately with the engineer's staff. Once the ideas are confirmed to be viable, the owner will be consulted for approval, the idea will be incorporated by the engineer into the design, and the change logged by PCL. By providing real-time input and not waiting to share these ideas until the next scheduled design review meeting, design of the project becomes more efficient and significant rework by the design engineer is avoided.

4.5.2 APPROACH TO SAFETY

**ONE OF THE
BEST SAFETY
RECORDS
IN THE
INDUSTRY** **.62
EMR**



SAFETY IS OUR CULTURE

The PCL Health and Safety program reflects our commitment to providing a safe and healthy work environment. While our safety record is consistently better than industry standards, we constantly strive for our goal of Zero Accidents on 100% of our projects. PCL strives for safety excellence through consistently evaluating our programs and the processes governing our work. Leadership actively participates by modeling the HSE policies to our project staff and front line craftworkers.

PCL's Safety Management Center (SMC) records safety items and ranks their hazard category as A, B, and C. An A-category hazard is an immediate safety concern and will be resolved before leaving an area. B-category identifies a likely to serious injury. C-category are likely to cause a minor injury. The B and C categories are non-immediate concerns that allow the team to discuss appropriate measures for remedy. The SMC program allows members to document safety walks on their smart phones to communicate issues quicker with other team members.

Alex Madrid is our Health, Safety, and Environmental Manager and will finalize our project safety review with all the project team members once mobilized onsite. All project staff are responsible for safety onsite. Monday

mornings begin with safety meetings hosted by the superintendent and project manager with all self-perform crews and subcontractor crews to discuss safety specifics for the work taking place that week. Our foreman and crew leads are required to fill out pre-job safety instructions for work tasks being performed. The project team is required to perform a weekly safety inspection of the site and document hazards and positive observations. In the Monday morning meeting, these hazards and positive observations are communicated back to the crews. Each project staff member is required to perform and document their own safety inspection monthly.

PCL intends to install a separate construction gate near the generation station. The entrance will be equipped with badge access to track all personnel onsite. It is anticipated material and equipment deliveries will stage in the gravel area along Riverside Avenue and be escorted onsite through the existing entrance gate on Riverside Avenue. Working inside an active facility and managing vehicle and personnel traffic will need to be reviewed and discussed with Operations on a regular basis to keep construction work going while maintaining plant operations. A project-specific safety plan can be found in **Appendix E**.

4.5.3 DESIGN-BUILD SCHEDULE

The proposed schedule, an executive summary that includes key milestones, government approval durations, design durations, procurement, construction, start-up and project turnover activities, is included in **Appendix F**. A brief roll-up is provided below.

The design schedule has been broken out to identify early works and overall works that will assist in the release of long lead items (LLI). Further development of these activities will need District involvement to incorporate any alternates or changes from what has been proposed.

Major equipment, underground piping, and selective construction areas are tied to the early works design, indicated below, and are due to long lead procurement durations and the limited design work needed to develop construction documents. Work in the field to assist the design will encompass investigative borings, potholing, and gathering asbuilt information to prepare the project geotechnical report. Construction will start with relocating existing underground utilities that conflict with the new retaining wall. Once existing underground utilities are relocated, the sheet pile installation can begin. A temporary road will be installed at the Effluent Pump Station to allow the CMU retaining wall to be installed without interrupting plant operations. Excavation will commence, bringing the grade down and re-establishing plant access from the parking lot to the ponds. Work will then move over to the Effluent Pump Station to shore, excavate, and construct the wet well tank and underground utility work at the new Filter Building.

TOP THREE

Benefits of Our Approach to the Project Schedule

1. Supports WWWD decision-making processes, procedures, and level of involvement expectations.
2. Uses a forward-looking approach to manage and mitigate potential schedule risks.
3. Engages operators early to avoid surprises during start up and commissioning.

Roemer WFF Upgrades & Expansion ROLL-UP SCHEDULE

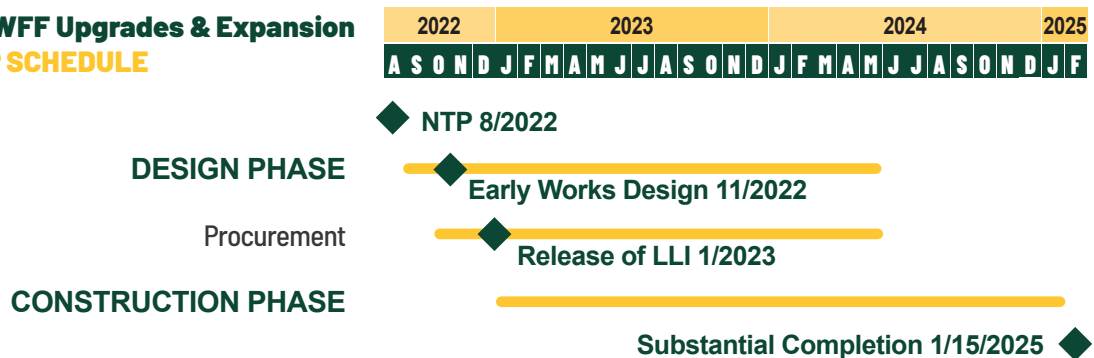

**Pursuant to the collaborative one-on-one RFP meeting with the District on May 27, 2022, PCL's team relayed that due to the current and uncertainty of the procurement supply chain climate, our proposed schedule will be adjusted to illustrate a more realistic timeline for successful completion.*

Underground utility construction will continue as work is further planned out with operations and access through the site. The major concrete work will move from the Effluent Pump Station to the Filter Building slab and then to DAF. The Influent Pump Station excavation and construction will begin once the pump can delivery is confirmed and the crew's sequencing of work is confirmed. The Filter Building will continue with installing the building, filters, mechanical, interior offices, and electrical work. This is the critical path on the project and represents the majority of the work.

The DAF, pump station, generator, and pond work will be scheduled as materials, equipment, crew loading, and plant operations are further coordinated. Sitework improvements will occur toward the latter part of the schedule as the need for construction parking on Riverside Avenue increases. Overall site asphalt work will be sequenced with operations. Functional testing and training will take place for each separate area prior to the full plant testing and final acceptance test.

We have analyzed the District's request to design and construct the project by August 2024. Due to the current market conditions of material delivery and obtaining schedule commitments from subcontractors, vendor, manufactures during the development of this schedule we have determined a 28-month duration is realistic to complete the design and construction.

The initiation of the project needs to be taken into consideration from formal announcement of successful respondent. Project set-up, staff allocation and certain activities can begin once formal announcement of successful respondent is received. However, execution of consultant agreements, subcontracts and purchase orders will be dependent on an executed DBIA agreement. We have seen other projects with two notices to proceed. NTP No. 1 would allow for the execution of



CASE STUDY

Tesla Water Treatment Facility, Tracy, CA

PCL implemented a construction plan to shorten the schedule and save costs at the San Francisco Public Utilities Commission (SFPUC) Tesla Treatment Facility project.

One of the main schedule constraints for this project involved five individual critical tie-ins that needed to be completed during an annual 35-calendar-day shutdown window. The original plan required these tie-ins to be completed in two separate shutdowns over two years. During preconstruction, PCL developed a detailed execution plan and day-by-day shutdown schedule that allowed the team to complete all five tie-ins during a single shutdown period. PCL successfully executed the plan during construction, reducing the project schedule by one year and saving nearly \$25 million in project costs for the owner.

KEYS TO MAINTAIN SCHEDULE COMPLIANCE

Our focus during design will be:

- Finalize any changes of the major equipment from the initial proposal as well as any design changes identified during the selection process
- Confirm early design package scope to accommodate the release of equipment, materials, and other documents to accommodate the construction schedule
- Implement field dimensions and detail as-built information into the design documents to alleviate changes to the design in the field
- Implement construction sequence activities into the design process. Implement construction tie-in sequence activities into the design drawings
- Maintain coordination of the overall design drawing with the procurement log to maintain the relationship between finalized design and releasing the remaining materials that will be dependent upon the final design. Exposed pipe fabrication, valves, instruments are some of the remaining items that will become critical if not released on time
- Maintain DDW involvement for timely issuance of Temporary Permit to Operate

agreements, project setup, permit processing, etc. NTP No. 2 would allow for the mobilization of labor and equipment to the site.

Underground piping material procurement remains a long lead item and fabrication times vary greatly due to project orders received at the pipe supply facilities. Portions of underground piping are directly tied to the critical path of the project, and require full coordination with the packaged filters. Early procurement of materials will help mitigate long lead item concerns. This solution also applies to electrical equipment, control, and SCADA systems.

DBIA 535 section 9.5 has been revised to address escalation of cost and time. Cost impacts have been adequately addressed for fair allocation of risk. However, schedule impacts are not as clearly defined. A price index does not contain schedule information and therefore the burden of proof will rely heavily on the contractor, or supplier to prove schedule delays due to unknown market changes. With the project set-up and supply chain concerns, we are proposing a 28-month schedule from NTP to Substantial Completion to properly design, schedule and react to market changes. We believe this time frame will allow for proper coordination with the District on market changes and ensure delivery of a high-quality project.

4.5.4 CASH FLOW

Our team has put together a cash flow chart and graph separately in the **Fixed Fee attachment**. The graph represents the anticipated monthly billings during phase 1 design and phase 2 construction. The impact of long lead equipment has been taken into account and represents the larger monthly percentages July thru October 2023.

Upon issuance of the notice to proceed, the Team will update the CPM schedule in **Appendix C** with the most current delivery dates based on market conditions. The CPM schedule will be cost loaded and used for the project schedule of values. The schedule will be reviewed and updated monthly. After review with the District and agreement of percent complete, a monthly billing will be generated and submitted for payment.

4.5.5 APPROACH TO START-UP & TESTING STEP BY STEP

STEP 1

MANUFACTURER CERTIFICATION OF INSTALLATION

Not only will PCL have each major process equipment manufacturer on-site to inspect their equipment, we will have them review associated pipe and appurtenances and verify that these do not present an issue with their equipment.

STEP 2

LOOP TESTING

PCL will verify signals from the point of origin back to SCADA via loop-by-loop checkout prior to testing for functionality.

STEP 3

FUNCTIONAL TESTING (ACCEPTANCE TESTING)

Following loop-by-loop checkouts, PCL will check the functionality of all process equipment prior to introducing flows. Each system will be checked to verify that it reacts as intended under varying flow characteristics. Filters 7, 8, and 9 will be run one at a time in "filter to waste" to ensure each unit is meeting water quality requirements.

STEP 4

PERFORMANCE / ACCEPTANCE TEST

Once functional testing is complete and the District receives the Temporary Permit to Operate the 30-day performance and acceptance test will begin.

Our approach to startup and testing begins prior to issuing major purchase order and subcontracts. An initial kickoff meeting will be held with all stakeholders to understand training availability of operations, required number of training sessions, key hold-points such as factory testing, and roles and responsibilities during startup, testing, and commissioning of systems. The details and expectations will be written into each subcontract and purchase order. At this time we will also coordinate with design activities to ensure proper fittings and other items required for startup are included in the design and drawings.

Prior to 25% completion, a second meeting will be held to review a global plan indicating proprietary equipment including MCC's, AFD's, PLC's, influent pumps, filters, UV vessels, effluent pumps, DAF units and the standby generator. We will discuss certification of installation, initial testing, functional testing and commissioning of all equipment. The expected outcome is the agreement on the general direction of startup and commissioning of the plant. A refined plan will be completed prior to the kickoff of startup activities.

Startup activities will begin once programming is complete, all electrical gear is ready for energizing and all lines have been pressure tested. The general procedures are outlined in on the left and startup activities will follow the below path:

- Vendor certification of installation on all electrical components and the standby generator. We will energize each system individually as each system becomes available for startup activities. Also, any remaining tie-in work outlined in **Appendix F** will be coordinated with operations staff and completed as required to startup the major systems.



- The next task will include vendor certification and startup of individual components including instrumentation, motor operated valves and gates throughout the facility, the overhead crane in filter building and other ancillary items such as motorized overhead doors. Functionality will be verified with SCADA and other startup items such as set points, torque, and scaling will be completed.
- The DAF facilities are currently showing to be the first major system that can be started-up. Depending on operational needs in the facility, this area could be started up and acceptance testing begin independently of the other areas.
- The next major system to be started-up is the effluent pump station to the reservoir. Depending on the operations of the plant and current flows, the start-up and turnover of the effluent pump station and acceptance test could begin prior to the filter startup.
- The startup of the filter building will begin with the startup of the influent pump station. We anticipate rotating a fitting on the 30" filter influent line and routing of temporary pipe back to the influent blending pond to create a loop to allow verification of flow along the pump curve. Other alarms such as temperature and pressure will be manipulated to verify proper functionality. Moving into the Filter Building, media installation will begin after the overhead crane startup is complete. The filter vendor will complete startup of the valves and instruments provided with their system and verify functionality

and programming of the filter control panel. Upon completion of local testing, signals and alarms will be verified with SCADA. Each filter will be tested in the filter to waste mode and water will flow through the filters to backwash ponds 5 & 6. Each filter will be tested independently during the functional testing. Once temporary permit to operate is received from DDW, all the filters will be put online and the Acceptance Test will begin.

During the Acceptance test and all processes are running, the backup generator will be tested to ensure backup power for the facility.

- The UV reactors will be removed one at a time and replaced with new. New reactors will be run for a minimum duration as agreed with operations to prove functionality. UV recovery pumps and GAC pumps will also be removed and replaced one at a time.
- Similar to the GAC and UV recovery pumps, each backwash recovery pump will be removed/replaced one at a time and placed into service for an agreed upon time.
- Other miscellaneous startup activities such as the Lytle Creek Parshall Flume and hypochlorite system will be completed during the same time as major systems.

Upon completion of the turnover of spare parts, operation and maintenance manuals, and other documentation, we will place the system into fully automatic operation and commence the commissioning period. Refer to **Appendix F** for preliminary start-up and commissioning plan.

4.5.6 ACCEPTANCE AND TRAINING PERIOD APPROACH

Operator training will start during the installation of the mechanical equipment and setting gear so the Operations staff can get a deeper understanding of the specifics to the project. The team will discuss how operations would like to conduct the training sessions and a training plan will be produced and submitted for approval. Training will commence during the startup and functional testing period for operation of individual systems.

Transitional Training

Overall SCADA system cutover, new Control and Laboratory area, analyzer cutover will have to be in conjunction with Plant Operations considering this is an active facility with new and expanded systems. Detailed meetings will address current operations and switching to a new control room.

Spare Parts

During the submittal phase, recommended spare parts will be proposed and recommended. Spare parts will be packaged separately during shipment and turned over to Plant Operations once received. A tracking log will be maintained in the event owner spare parts are needed during startup. This will allow proper replacement of inventory.

Warranty

Draft warranties will be submitted prior to the acceptance period to ensure timely deliver and approval of equipment warranties. Once substantial completion date is determined. Warranties will be finalized and submitted as a requirement to final acceptance.

O&M Manuals

Draft operations and maintenance (O&M) manuals will be submitted for general conformance to the design. The manuals will be used during Functional and Acceptance Training. The startup and commissioning manager will track and document changes and additions flagged during testing and training to ensure O&M Manuals properly address site conditions that will be valuable for future plant operators.

Operations Plan

A final compliance check of regulatory changes will be conducted to ensure the final Plant Operations Plan meets all regulatory requirements.



EXHIBIT B



STANDARD FORM OF GENERAL CONDITIONS OF CONTRACT BETWEEN OWNER AND DESIGN-BUILDER

Document No. 535

Second Edition, 2010
© Design-Build Institute of America
Washington, DC

TABLE OF CONTENTS

Article Name	Page
<u>Article 1</u>	2
General	2
<u>Article 2</u>	5
Design-Builder’s Services and Responsibilities.....	5
<u>Article 3</u>	24
Owner’s Services and Responsibilities.....	24
<u>Article 4</u>	25
Hazardous Conditions and Differing Site Conditions.....	25
<u>Article 5</u>	27
Insurance and Bonds	27
<u>Article 6</u>	29
Payment.....	29
<u>Article 7</u>	34
Indemnification	34
<u>Article 8</u>	36
Time	36
<u>Article 9</u>	40
Changes to the Contract Price and Time	40
<u>Article 10</u>	44
Contract Adjustments and Disputes	44
<u>Article 11</u>	47
Suspension and Termination for Cause	47

Article 12 50

Electronic Data 50

Article 13 51

Miscellaneous 51

Article 1

General

1.1 Mutual Obligations

1.1.1 Owner and Design-Builder commit at all times to cooperate fully with each other and proceed on the basis of trust and good faith, to permit each party to realize the benefits afforded under the Contract Documents.

1.2 Basic Definitions

1.2.1 Agreement or Contract refers to the executed contract between Owner and Design-Builder and includes DBIA Document No. 535, *Standard Form of General Conditions of Contract Between Owner and Design-Builder* (2010 Edition) and DBIA Document No. 545, *Design-Build Agreement for Water and Wastewater Projects* (2016 Edition), and all Exhibits and documents incorporated therein.

1.2.1 Allowance is an amount established by the District for a scope of work which has been identified, but which has not yet been fully defined.

1.2.2 Basis of Design Documents are as follows: Exhibit A "Design Criteria Report", and those documents specifically listed in, as applicable, in Exhibit C "*List of Reference Documents*".

1.2.3 Change Directive is a directive issued by the Owner, at the Owner's sole discretion, to the Design-Builder to recognize that there is a potential Change Order to the Contract and provide the Design-Builder with direction on a path forward on the potential changed work.

1.2.4 Change Order is a contractually binding amendment to the Contract, which shall comply with the Change Order provisions of the Contract Documents.

1.2.5 Construction Documents are the documents, consisting of Drawings and Specifications, to be prepared or assembled by the Design-Builder consistent with the Design-Builder's accepted proposal and the Basis of Design Documents unless a deviation from the Basis of Design Documents is processed as a Change in accordance with Article 9 herein, as part of the design review process contemplated by Section 2.4 of these General Conditions of Contract.

1.2.6 Construction Services include construction, testing, commissioning, and acceptance for the Project, and all other work as needed to complete the Work as provided for in the Construction Documents.

1.2.7 Contract Documents are those documents identified in Article 3 of the DBIA Document No. 545.

1.2.8 Contract Price or Design-Build Price refers to the amounts set forth in Article 7 of the DBIA Document No. 545.

1.2.9 Contract Time refers to the time periods set forth in Article 6 of the DBIA Document No. 545.

1.2.10 Contractor's Construction Schedule is the Design-Builder's schedule for the Construction Services scope of work that complies with the scheduling requirements of the Contract Documents and clearly identifies the Critical Path of the Work.

1.2.11 Date of Commencement – As defined in Article 6 of the DBIA Document No. 545.

1.2.12 Day or Days shall mean calendar days unless otherwise specifically noted in the Contract Documents.

1.2.13 Design-Builder is the party to the Contract that is responsible for design, construction, commissioning and acceptance testing, and training and other services as defined by the Contract Documents. Any and all references to Contractor and Contractor's obligations are applicable to the Design-Builder.

1.2.14 Design-Build Team is comprised of the Design-Builder, the Design Consultant, and key Subcontractors identified by the Design-Builder.

1.2.15 Design Consultant is a qualified, licensed in the State of California design professional who is not an employee of Design-Builder, but is retained by Design-Builder, or employed or retained by anyone under contract with Design-Builder, to furnish design services required under the Contract Documents. A Design Sub-Consultant is a qualified, licensed in the State of California design professional who is not an employee of the Design Consultant, but is retained by the Design Consultant or employed or retained by anyone under contract to Design Consultant, to furnish design services required under the Contract Documents.

1.2.16 Design Criteria Report describes the Owner's program requirements and objectives for the Project, including use, space, price, time, site and expandability requirements, as well as submittal requirements and other requirements governing Design-Builder's performance of the Work. The Design Criteria Report is attached as Exhibit "A" and may include conceptual documents, design criteria, design performance specifications, design specifications, and LEED® or other sustainable design criteria and other Project-specific technical materials and requirements.

1.2.17 Design Services are those services as defined in Article 2 of the General Conditions and in the Contract Documents.

1.2.18 Not Used

1.2.19 Final Acceptance occurs once all requirements of Final Completion have occurred, and the Owner issues a Letter of Final Acceptance.

1.2.20 Final Application for Payment is the Design-Builder's request for final payment after Final Acceptance has occurred and a Letter of Final Acceptance has been issued by the Owner.

1.2.21 Final Completion is the date on which all Work is complete in accordance with the Contract Documents, including but not limited to, any items identified in the punch list prepared under General Conditions Section 6.6 and the submission of all documents and satisfaction of all requirements therein.

1.2.22 Force Majeure Events are those events set forth in Article 8 of the General Conditions.

1.2.23 General Conditions of Contract refer to this DBIA Document No. 535, *Standard Form of General Conditions of Contract Between Owner and Design-Builder* (2010 Edition).

1.2.24 Hazardous Conditions are any materials, wastes, substances and chemicals deemed to be hazardous under applicable Legal Requirements, or the handling, storage, remediation, or disposal of which are regulated by applicable Legal Requirements.

1.2.25 Holiday(s) - The day upon which the Owner is closed during normal business hours in observance of one of its holidays.

1.2.25 Legal Requirements are all applicable federal, state and local laws, codes, ordinances, rules, regulations, orders and decrees of any government or quasi-government entity having jurisdiction over the Project or Site, the practices involved in the Project or Site, or any Work.

1.2.26 Notice to Proceed is the written notice from the Owner to the Design-Builder establishing the dates for Design Services and/or Construction Services, and which authorizes the Design-Builder to commence with Design Services and/or Construction Services. The effective date of the Notice to Proceed shall be no later than the date the Kick-Off meeting is held.

1.2.27 Other Contractors shall mean any contractors, service providers, suppliers or vendors performing construction, maintenance, operations, or repairs in and around the Project Site who are not in contractual privity with Design-Builder.

1.2.28 Owner (or District) shall mean the West Valley Water District, acting through its Board of Directors. Owner may include Owner's Representative, where appropriate delegation has occurred.

1.2.29 Owner's Representative shall mean person, persons, or entity to whom the Owner may delegate responsibilities to, to fulfill the duties of Owner as identified in Contract Documents.

1.2.30 Project shall mean the West Valley Water District Oliver P. Roemer Water Filtration Facility Upgrades and Expansion Project, and includes the total design, construction, and testing and commissioning of the Work under the Contract and all other work, labor, equipment, and materials necessary to accomplish the Project.

1.2.31 Proposal is the Design-Builder's submittal in response to the Owner's Request for Proposal, which includes the Design-Builder's progressed design submittal and upon which the Design-Builder based its fixed Design-Build Price.

1.2.32 Site or Project Site is the land or premises on which the Project is located, and includes all areas designated for staging, storage, parking and temporary offices as indicated in the Contract Documents.

1.2.33 Subcontractor is any person or entity retained by Design-Builder as an independent contractor to perform a portion of the Work and shall include materialmen and suppliers.

1.2.34 Sub-Subcontractor is any person or entity retained by a Subcontractor as an independent contractor to perform any portion of a Subcontractor's Work and shall include materialmen and suppliers.

1.2.35 Substantial Completion or Substantially Complete means the date on which Design-Builder has satisfied all of the requirements for Substantial Completion under the Contract Documents, and the Work, or an agreed upon portion of the Work, is sufficiently complete in accordance with the Contract Documents so that Owner can occupy and use the Project for its intended purposes.

1.2.36 Work is comprised of all Design-Builder's design, construction and other services required by the Contract Documents, including procuring and furnishing all materials, equipment, services and labor reasonably inferable from the Contract Documents.

1.2.37 Work Products are all works, tangible or not, created under the Contract for the Owner, as defined under Article 5 of the DBIA Document No. 545.

Article 2

Design-Builder's Services and Responsibilities

2.1 General Services

2.1.1 The Design-Builder will designate in writing a contact person ("Design-Builder's Representative") for coordination and communication with Owner. The Design-Builder's Representative shall have the authority to make decisions for the Design-Builder firm and shall have binding signatory power for changes in work. The Design-Builder's Representative and/or his or her designee shall be on the Project Site at all times during work activity. Design-Builder's Representative shall be reasonably available to Owner and shall have the necessary expertise and experience required to supervise the Work. Design-Builder's Representative shall communicate regularly with Owner and shall be vested with the authority to act on behalf of Design-Builder. Design-Builder's Representative may be replaced only with the mutual agreement of Owner and Design-Builder.

2.1.2 An orderly system for communication between Owner and the Design-Builder is essential to the satisfactory completion of the Work. Owner will transmit, directly or through others, written instructions, responses or other communications to the Design-Builder's Representative or other persons identified in writing by the Design-Builder to receive such communications. The Design-Builder shall, by a letter to Owner, designate (by name) one or more staff members to receive oral and written field communications when the Design-Builder's Representative is away from the Project Site and to act as the designated representative. During the times that the Design-Builder's Representative may be temporarily absent, a staff member shall be authorized to act immediately on orders or instructions issued by Owner. If Owner finds it necessary to communicate with the Design-Builder Personnel authorized to receive such communications and none are available to receive such communications, Owner may suspend all or a portion of the Design-Builder's operations at the Project Site to the extent affected by such communications until such communications can be accomplished. Formal communications from the Design-Builder to Owner that are necessary for the performance of the Contract, including documents described in the Contract Documents, and any other written communications, will be addressed to Owner, unless otherwise specified in the Contract Documents. All written communications or submittals shall be signed by the Design-Builder's Representative or designee in serialized format, and Design-Builder shall maintain logs available to Owner for review and reconciliation upon request.

2.1.3 The Design-Builder represents it has the proper business and professional background, knowledge, experience and expertise necessary to provide all Design Services and Construction Services for the Project. Design-Builder further represents that it and all Design-Builder's subcontractors possess all required licenses in the State of California to provide all Design Services and Construction Services necessary for the Project.

2.1.4 Design-Builder makes certain representations in the Contract Documents, including without limitation, the representations in this clause. Design-Builder is deemed to make these representations by and as a condition of submission of Design-Builder's proposal. Design-Builder agrees that it has single point responsibility for the design and construction of this Project. Following award and execution of the Contract, these representations are deemed republished throughout the performance of the Work of the Contract and shall also be treated as express warranties.

2.1.5 Design-Builder has at the time of Proposal, and will throughout performance, carefully and adequately reviewed the Contract Documents and acknowledges that these Contract Documents establish the scope, level of quality, construction intent and the procedures for the Design-Builder's design and construction of the Work to a state of Final Completion. Design-Builder shall carefully study and compare each of the Contract Documents with the others and with information furnished by Owner, and shall report in writing to Owner any errors, inconsistencies, or omissions in the Contract Documents or inconsistencies with program performance requirements or applicable

Code requirements observed by Design-Builder.

2.1.6 Design-Builder has at the time of Proposal, and will throughout performance, carefully examine the Project Site and the adjacent areas, has adequately investigated the nature and location of the Work to be performed and has satisfied itself and will continue to satisfy itself as to the general and local conditions which will be applicable, including but not limited to:

2.1.6.1 Conditions related to Project Site access and topography, and to the transportation, disposal, handling and storage of materials;

2.1.6.2 The availability of labor, water, power and roads;

2.1.6.3 Observable physical conditions at the Project Site and existing Project Site conditions, including seasons and climate;

2.1.6.4 Size, utility capacities and connection options of external utilities;

2.1.6.5 The surface conditions of the ground, including normal and usual soil conditions;

2.1.6.6 The character and availability of the equipment and facilities which will be needed prior to and during the performance of the construction work; and

2.1.6.7 All other conditions which may be material to the Design-Builder's performance of its obligations under this Contract.

2.1.7 Design-Builder has at the time of Proposal, and will throughout performance, have the experience and capability to efficiently and expeditiously accomplish the Work required under this Contract in a timely and satisfactory manner and at the standard of practice of a Design-Builder with substantial experience in the Work of the Contract.

2.1.8 Design-Builder shall supervise, coordinate, and direct the Work using Design-Builder's best skill and attention. Design-Builder shall be solely responsible for, and have control over the entire design effort, construction means, methods, techniques, sequences, procedures, and the coordination of all portions of the Work, including, but without limitation, site work, utilities, and building process systems.

2.1.9 The Design-Builder shall coordinate, sequence, and organize its work so as to minimize the inconvenience and disruption to both the Owner and general public to the greatest extent reasonable. Such coordination and mitigation shall include dissemination of information and meeting with or notification to the parties who will be affected by the Work, as appropriate, and shall be undertaken in cooperation with Owner, and in accordance with any specific Contract Document provisions or direction from Owner. Prior to commencement of the Work, the Design-Builder shall hold pre-installation coordination meetings and prepare coordination drawings that document the pre-planning of the Work. This process shall ensure the installation of the Work is undertaken in an efficient and professional manner in accordance with the Contract Documents. In the event that the Owner in good faith determines that the Design-Builder has not complied with this provision, or has failed to properly address the inconvenience and/or a disruption to the general public or Owner, the Owner shall have the right to change the sequence of the Work by providing the Design-Builder with 48 hours' notice, and the Design-Builder will not be entitled to any additional time or compensation resulting from the change in the sequence of the Work. The Design-Builder's coordination shall include, but not be limited to, the following:

2.1.9.1 Coordinate use of Project space and sequence of installation of equipment or other work that is indicated on the Contract Documents. Utilize space efficiently to eliminate conflicts in the installation of the Work and to maximize accessibility for maintenance and repairs.

2.1.9.2 When necessary, prepare memoranda for distribution to each party involved in the Work outlining special procedures required for coordination and construction. Include such items as required notices, reports, construction restraints and attendance at meetings.

2.1.9.3 Coordinate schedule and timing of required administrative procedures with other construction activities to avoid conflicts and ensure orderly progress of the Work.

2.1.9.4 The Design-Builder shall obtain the approval of Owner and notify all other affected persons or "Other Contractors" at least forty-eight (48) hours before starting work which may block access or otherwise cause undue difficulty to occupants or users of property affected, and shall restore such access to a usable condition or, with Owner's permission, provide replacement access as soon as possible.

2.1.9.5 The Design-Builder shall obtain necessary information and identify equipment locations and other layouts, as available, to avoid interface conflicts and shall be familiar with applicable codes and requirements and perform its work in compliance therewith.

2.1.9.6 Coordinate execution of the Work with those public utilities, governmental bodies, private utilities and Other Contractors performing work on and adjacent to the worksites. Eliminate or minimize delays in the Work and conflicts with those utilities, bodies and Other Contractors.

2.1.10 Design-Builder shall be responsible for inspection of all portions of the Work, including those portions already performed under this Contract, to determine that such portions conform to the requirements of the Contract Documents and are ready to receive subsequent Work.

2.1.11 The Design-Builder shall be solely responsible for the costs to reperform any Work or Services resulting from any and all design that fails to conform to the Design Standard of Care including errors, inconsistencies or omissions in the Construction Documents. Design-Builder shall take field measurements, verify field conditions, and carefully compare with the Contract Documents such field measurements, conditions, and other information known to Design-Builder before commencing the construction. Errors, inconsistencies, or omissions discovered at any time shall be promptly reported in writing to Owner.

2.1.12 Design-Builder further represents and warrants it will continuously furnish the necessary personnel to complete the Project on a timely basis as required in this Contract and that such personnel have the experience and expertise levels to adequately perform the work. Design-Builder's representations and warranties stated herein, shall also apply to Design-Builder's subcontractors.

2.1.13 Design-Builder shall provide Owner with a monthly status report detailing the progress of the Work, including (i) whether the Work is proceeding according to schedule, (ii) whether discrepancies, conflicts, or ambiguities exist in the Contract Documents that require resolution, (iii) whether health and safety issues exist in connection with the Work; and (iv) other items that require resolution so as not to jeopardize Design-Builder's ability to complete the Work for the Contract Price and within the Contract Time(s).

2.1.14 Within seven (7) days after execution of the Agreement, Design-Builder shall coordinate a "Kickoff Meeting" with the Owner to discuss issues affecting the administration of the Work and to implement the necessary procedures, including those relating to schedule, submittals and payment, to facilitate the ability of the parties to perform their obligations under the Contract Documents. At this Kickoff Meeting, Design-Builder shall submit a comprehensive project schedule covering all activities from the time of the Kickoff Meeting to Final Completion, which clearly identifies the Critical Path throughout the course of the Work. The schedule shall be subsequently revised as required by conditions and progress of the Work, but such revisions shall not relieve Design-Builder of its obligations to complete the Work within the Contract Time(s), as such dates

may be adjusted in accordance with the Contract Documents. Owner's review of, and response to, the schedule shall not be construed as relieving Design-Builder of its complete and exclusive control over the means, methods, sequences and techniques for executing the Work. Owner will issue Notice to Proceed for Design Services with the effective date being the same date as the Kickoff Meeting.

2.1.16 The Design-Builder shall conduct progress meetings in compliance with the Contract Documents, unless otherwise agreed in writing. The Design-Builder shall schedule a Preconstruction Conference following receipt of the Notice to Proceed for Construction Services to discuss the Design-Builder's construction and scheduling requirements in Section 2.12 of the General Conditions. For all meetings, the Design-Builder shall make arrangements for meetings and prepare agendas with copies for participants. For meetings between Owner and the Design-Builder, Owner will record minutes and distribute. The Design-Builder shall be advised of and shall attend Contract meetings as deemed necessary by Owner and at no additional cost. The Design-Builder shall inform Owner at least forty-eight (48) hours in advance of any Project-related meeting(s) where Design-Builder intends to have a lawyer present.

2.2 Design Professional Services

2.2.1 Design-Builder shall, consistent with applicable state licensing laws, provide through qualified, licensed design professionals employed by Design-Builder, or procured from qualified, independent licensed Design Consultants, the necessary design services, including architectural, engineering and other design professional services, for the preparation of the required drawings, specifications and other design submittals to permit Design-Builder to complete the Work consistent with the Contract Documents. Nothing in the Contract Documents is intended or deemed to create any legal or contractual relationship between Owner and any Design Consultant.

2.3 Standard of Care for Design Professional Services

2.3.1 The standard of care for all design professional services performed to execute the Work shall be the care and skill ordinarily used by members of the design profession practicing under similar conditions at the same time and locality of the Project. Design-Builder agrees to provide its professional services in a manner that is in the Owner's economic and governmental best interests, consistent with this standard of care and the Design-Builder's professional obligations.

2.4 Design Development Services

2.4.1 Upon receipt of the Notice to Proceed for Design Services, the Design-Builder shall commence the design and the preparation of the Construction Documents per the terms of the Contract and as provided in Exhibit B, *Scope of Services*. The Construction Documents shall provide information customarily necessary in documents for projects of similar size, complexity, and quality. The Construction Documents shall include all information required to complete the construction of the Project, other than such details customarily developed by others during construction.

2.4.2 Contract Schedule shall indicate the times for Owner to review the completion of each such portion of the Construction Documents and a reasonable time but not less than 14 days for review of same. Design-Builder and Owner shall, consistent with any applicable provision of the Contract Documents, agree upon any interim design submissions that Owner may wish to review, which interim design submissions may include design criteria, drawings, diagrams and specifications setting forth the Project requirements. Interim design submissions shall be consistent with the Basis of Design Documents, as the Basis of Design Documents may have been changed through the design process set forth in this Section. On or about the time of the scheduled submissions, Design-Builder and Owner shall meet and confer about the submissions, with Design-Builder identifying during such meetings, among other things, the evolution of the design and any changes to the Basis of Design Documents, or, if applicable, previously submitted design submissions. Changes

to the Basis of Design Documents, including those that are deemed minor changes under Section 9.3.1, shall be processed in accordance with Article 9. Minutes of the meetings, including a full listing of all changes, will be maintained by Design-Builder and provided to all attendees for review. Following the design review meeting, Owner shall review and either approve, or state what modifications need to be made before such approval is given, the interim design submissions and meeting minutes in a time that is consistent with the turnaround times set forth in Design-Builder's schedule.

2.4.3 Design-Builder shall submit Construction Documents to Owner setting forth in detail drawings and specifications describing the requirements for construction of the Work. The Construction Documents shall be consistent with the latest set of interim design submissions, as such submissions may have been modified in a design review meeting and recorded in the meetings minutes. The parties shall have a design review meeting to discuss, and Owner shall review and either approve or state what modifications need to be made before such approval is given, the Construction Documents in accordance with the procedures set forth in Section 2.4.1 above. Design-Builder shall proceed with construction in accordance with the approved Construction Documents and shall submit one set of approved Construction Documents to Owner prior to commencement of construction.

2.4.4 Owner's review and approval of interim design submissions, meeting minutes, and the Construction Documents is for the purpose of mutually establishing a conformed set of Contract Documents compatible with the requirements of the Work. Neither Owner's review nor approval of any interim design submissions, meeting minutes, and Construction Documents shall be deemed to transfer any design liability from Design-Builder to Owner, nor shall it relieve the Design-Builder from its duty to utilize the Design Standard of Care in the performance of its duties.

2.4.5 To the extent not prohibited by the Contract Documents or Legal Requirements, the Owner may request that the Design-Builder prepare interim design submissions and Construction Documents for a portion of the Work to permit construction to proceed on that portion of the Work prior to completion of the Construction Documents for the entire Work. Interim design submissions shall be consistent with the Basis of Design Documents, as the Basis of Design Documents may have been changed through the design process set forth in this Section. On or about the time of the scheduled submissions, Design-Builder and Owner shall meet and confer about the submissions, with Design-Builder identifying during such meetings, among other things, the evolution of the design and any changes to the Basis of Design Documents, or, if applicable, previously submitted design submissions. Following the design review meeting, Owner shall review and either approve, or state what modifications need to be made before such approval is given, the interim design submissions and meeting minutes in a time that is consistent with the turnaround times set forth in Design-Builder's schedule.

2.5 Legal Requirements

2.5.1 Design-Builder shall perform the Work in accordance with all Legal Requirements and shall provide all notices applicable to the Work as required by the Legal Requirements.

2.5.2 Subject to notice and scheduling provisions, where revisions are required to be made to the Construction Documents resulting in a change in the construction because of changes in Legal Requirements, the Contract Price and/or Contract Time(s) may be adjusted to compensate Design-Builder for the effects of any changes in the Legal Requirements enacted after the date of the Agreement. This Article 2.5.2 shall not apply where there is a Force Majeure event resulting in changes to the Legal Requirements, in which case, Article 8.3 will apply.

2.6 Government Approvals and Permits

2.6.1 Except as identified in Exhibit E to the Agreement (*Permits and Approvals*), Design-Builder shall obtain and pay for all necessary permits, approvals, licenses, government charges and inspection fees required for the prosecution of the Work by any government or quasi-government entity having jurisdiction over the Project.

2.6.2 Design-Builder shall provide reasonable assistance to Owner in obtaining those permits, approvals and licenses that are Owner's responsibility.

2.7 Design-Builder's Construction Services

2.7.1 Unless otherwise provided in the Contract Documents to be the responsibility of Owner or a separate contractor, Design-Builder shall provide through itself or Subcontractors the necessary supervision, labor, inspection, testing, start-up, material, equipment, machinery, temporary utilities and other temporary facilities to permit Design-Builder to complete construction of the Project consistent with the Contract Documents. If a request to the Owner is made to provide water service, Owner will provide water in accordance with its prevailing policies and practices.

2.7.2 Design-Builder shall perform all construction activities efficiently and with the requisite expertise, skill and competence to satisfy the requirements of the Contract Documents. Design-Builder shall at all times exercise complete and exclusive control over the means, methods, sequences and techniques of construction.

2.7.3 Design-Builder shall employ only Subcontractors who are responsible, duly licensed and qualified to perform the Work consistent with the Contract Documents. Owner may reasonably object to Design-Builder's selection of any Subcontractor or request removal of the Subcontractor on the basis that the Subcontractor is not responsible or has not satisfied the Contract requirements. If the Owner does not consent to the selection of any subcontractor or requests removal, which consent shall not be unreasonably withheld or removal unreasonably requested, then the Design-Builder shall select or replace the subcontractor in compliance with the Contract requirement, at no cost or time impact to the Owner.

2.7.4 Design-Builder assumes responsibility to Owner for the proper performance of the Work of Subcontractors and any acts and omissions in connection with such performance. Nothing in the Contract Documents is intended or deemed to create any legal or contractual relationship between Owner and any Subcontractor or Sub-Subcontractor, including but not limited to any third-party beneficiary rights.

2.7.5 Design-Builder shall coordinate the activities of all Subcontractors. If Owner performs other work on the Project or at the Site with separate contractors under Owner's control, Design-Builder agrees to reasonably cooperate and coordinate its activities with those of such separate contractors so that the Project can be completed in an orderly and coordinated manner without unreasonable disruption.

2.7.6 Design-Builder shall keep the Site reasonably free from debris, trash and construction wastes to permit Design-Builder to perform its construction services efficiently, safely and without interfering with the use of adjacent land areas. Upon Substantial Completion of the Work, or a portion of the Work, Design-Builder shall remove all debris, trash, construction wastes, materials, equipment, machinery and tools arising from the Work or applicable portions thereof to permit Owner to occupy the Project or a portion of the Project for its intended use.

2.7.7 Except in connection with the safety or protection of persons or the Work or property at the site or adjacent thereto, and except as otherwise indicated in the Contract Documents, Design-Builder shall perform all Work at the site during regular working hours, and do not permit overtime work or the performance of work on Saturday, Sunday, or any Holiday observed by the Owner,

without the Owner's written consent. It shall apply for this consent through the Owner's Representative. The Owner's Representative shall approve working on Holidays, weekends, or overtime, at no additional cost to the Owner if such work was requested by the Design-Builder. Design-Builder shall reimburse the Owner for all costs to provide inspection services required to monitor the Holiday, weekend or overtime work. The Owner shall charge its direct hourly cost plus the Owner's overhead cost to Design-Builder, and a deductive change order will be written and Design-Builder shall sign it to cover this cost.

2.8 Design-Builder Subcontracts

2.8.1 Design-Builder shall use only Responsible (as defined by California Public Contract Code section 1103) and qualified Subcontractors and material suppliers. Unless previously identified in Design-Builder's Proposal, before making an award to a Subcontractor or material supplier, the Design-Builder shall identify in writing to the Owner the name, qualifications, experience, contact and licensing information, and scope of work for each proposed Subcontractor or material supplier. The Design-Builder shall provide the Owner with a letter which provides all necessary information demonstrating that the proposed subcontractor or material supplier satisfies the Contract requirements, including but not limited to, insurance provisions. If requested, Design-Builder will promptly provide additional information requested by Owner pending concurrence from Owner. The Owner reserves the right, which shall be exercised in good faith, to reasonably deny or remove a Subcontractor, Sub-subcontractor, or material supplier in the event the Owner determines that the Subcontractor, Sub-subcontractor, or material supplier is not Responsible, or that the subcontractor or material supplier fails to satisfy or violates the requirements under the Contract Documents. Nothing herein shall be construed to relieve the Design-Builder from its obligations to properly manage, supervise, schedule, or coordinate its Subcontractors and material suppliers.

2.8.2 All subcontracts will be between the Design-Builder and the Subcontractors. Subcontracts should be written to protect Owner from impacts and claims arising from the Work. A copy of every subcontract shall be furnished to Owner at least five (5) calendar days prior to execution of the subcontract by Design-Builder. The Design-Builder shall be responsible to Owner for the acts and omissions of its agents and employees, suppliers, Subcontractors, and Sub-subcontractors performing work under a contract with the Design-Builder, and of its lower tier subcontractors, agents or employees. The Design-Builder shall require each Subcontractor to be bound to the Design-Builder by the terms of the Contract Documents, and to assume toward the Design-Builder all applicable obligations and responsibilities which the Design-Builder, by these Contract Documents, assumes toward Owner. Said Contract shall preserve and protect the rights of Owner under the Contract Documents with respect to the Work to be performed by the Subcontractors that the subcontracting thereof will not prejudice such rights. Where appropriate, the Design-Builder shall require each Subcontractor to enter into similar Contracts with the Sub-subcontractors. The Design-Builder shall make available to each proposed Subcontractor, prior to the execution of the subcontract, copies of the Contract Documents and the Contractor's Construction Schedule, to which the Subcontractor shall similarly make copies of such Contract Documents available to their Sub-subcontractors. Each Subcontractor will be bound by this Article. Subcontractors also shall be provided access to all Requests for Information (RFI's), Schedule Updates, and any other information that arises during the performance of the Work. No subcontract or purchase order shall bind or purport to bind Owner. Each subcontract or purchase order shall provide, without requiring the prior consent of the relevant Subcontractor or supplier, for assignment and delegation of such subcontract or purchase order by Design-Builder to Owner in the event of a default by the Design-Builder. If Owner elects to assume by assignment any subcontract or purchase order as described in this Article, then Design-Builder shall enter into reasonable assignment documentation requested by Owner which may be required to effect such assignment.

2.8.3 The Design-Builder shall make no substitution for any Subcontractor, person or entity previously selected without the prior written concurrence of Owner, which concurrence will be provided at the Owner's sole discretion.

2.9 Design-Builder's Responsibility for Project Safety

2.9.1 Design-Builder recognizes the importance of performing the Work in a safe manner so as to prevent damage, injury or loss to (i) all individuals at the Site, whether working or visiting, (ii) the Work, including materials and equipment incorporated into the Work or stored on-Site or off-Site, and (iii) all other property at the Site or adjacent thereto. Design-Builder assumes responsibility for implementing and monitoring all safety precautions and programs related to the performance of the Work. Design-Builder shall, prior to commencing construction, designate in writing a Safety Representative with the necessary qualifications and experience to supervise the implementation and monitoring of all safety precautions and programs related to the Work. Unless otherwise required by the Contract Documents, Design-Builder's Safety Representative shall be an individual stationed at the Site who may have responsibilities on the Project in addition to safety. The Safety Representative shall make routine daily inspections of the Site and shall hold weekly safety meetings with Design-Builder's personnel, Subcontractors and others as applicable.

2.9.2 Design-Builder and Subcontractors shall comply with all Legal Requirements relating to safety, including but not limited to, all pertinent safety laws and regulations and orders of the State of California, Department of Industrial Relations, Division of Industrial Safety, and U.S. Department of Labor, OSHA, as well as any Owner-specific safety requirements set forth in the Contract Documents, provided that such Owner-specific requirements do not violate any applicable Legal Requirement. Design-Builder will immediately report in writing any safety-related injury, loss, damage or accident arising from the Work to Owner's Representative and, to the extent mandated by Legal Requirements, to all government or quasi-government authorities having jurisdiction over safety-related matters involving the Project or the Work.

2.9.3 Design-Builder's responsibility for safety under this Section is not intended in any way to relieve Subcontractors and Sub-Subcontractors of their own contractual and legal obligations and responsibility for (i) complying with all Legal Requirements, including those related to health and safety matters, and (ii) taking all necessary measures to implement and monitor all safety precautions and programs to guard against injuries, losses, damages or accidents resulting from their performance of the Work.

2.9.4 The Design-Builder shall conduct all operations in a manner that will cause no interference with normal operations of the Owner. In all operations, the Design-Builder shall be governed by the regulations and rules of Owner and shall cooperate fully with Owner. All temporary blockages for the movement of construction materials or equipment shall be coordinated with and approved by Owner at least forty-eight (48) working hours in advance of any closure. The Design-Builder shall provide and maintain temporary and permanent fences, barriers, lights, bridges, and signs and provide such flaggers and guards as necessary to give adequate warning to the public and all individuals on or using the premises.

2.9.5 Within ten (10) Days after the date of the Notice to Proceed and before moving vehicles onto the Project Site, the Design-Builder shall submit to Owner the proposed Plan for vehicular and pedestrian traffic circulation, including the location and types of signs to be used. Thereafter, and not later than fifteen (15) Days prior to subsequent changes required by Owner for said circulation, sign locations and types, the Design-Builder shall submit revised plans to Owner.

2.9.6 The Design-Builder shall conduct the operations in a manner that avoids injury or damage to adjacent property and improvements. Property such as, but not limited to, buildings, trees, shrubbery, lawns, pole lines, fences, guard rails, guide posts, culvert and Project markers, signs, structures, and other objects on or adjacent to the Project Site, that are not designated for removal, shall be protected from injury or damage. If damaged or removed due to Design-Builder's operations, they shall be restored or replaced in as nearly, but not less than, the original condition and location as is reasonably possible. When ordered by Owner, the Design-Builder shall provide and install suitable safeguards to protect any object from injury or damage.

2.9.7 If the Design-Builder causes damage to the Work, property, or person of any other contractor utilized by the Owner, or if any claim arising out of the Design-Builder's performance of the Work is made against the Design-Builder by any other contractor, the Owner, or any other person, Design-Builder shall promptly attempt to settle and resolve the dispute.

2.10 Design-Builder's Warranty

2.10.1 Design-Builder warrants to Owner that the construction, including all materials and equipment furnished as part of the construction, shall be new unless otherwise specified in the Contract Documents, of good quality, in conformance with the Contract Documents and free of defects in materials and workmanship.

2.10.2 All Work shall be warranted by the Design-Builder against defective workmanship and materials for the warranty period of one year after Substantial Completion by Design Builder, or as covered by special warranties, whichever is longer. In the event that an element of work is scheduled to be and is completed and is in beneficial use prior to Substantial Completion, with the Owner's express written concurrence, the warranty for the equipment in each completed element of work shall begin once that element of work has been achieved by the Design-Builder, accepted and placed into use and operation by the Owner. Neither Final Acceptance nor the final payment nor any provision in the Contract Documents shall relieve the Design-Builder of responsibility for faulty material or quality of Work. The Design-Builder shall replace or repair any such defective Work in a manner satisfactory to Owner, after notice to do so from Owner and within the time specified in the notice.

2.10.3 Disclaimers and Limitations: Manufacturer's disclaimers and limitations on product warranties do not relieve Design-Builder of warranty on work that incorporates products. Manufacturer's disclaimers and limitations on product warranties do not relieve suppliers, manufacturers, and subcontractors required to countersign special warranties with Design-Builder.

2.10.4 Related Damages and Losses: When correcting failed or damaged warranted construction, remove and replace construction that has been damaged as a result of such failure or must be removed and replaced to provide access for correction of warranted construction.

2.10.5 Reinstatement of Warranty: When work covered by warranty has failed and been corrected by replacement or rebuilding, reinstate warranty by written endorsement. Reinstated warranty shall be equal to original warranty with equitable adjustment for depreciation.

2.10.6 Replacement Cost: Upon determination that work covered by warranty has failed, replace or rebuild work to acceptable condition complying with requirements of Contract Documents. Design-Builder is responsible for cost of replacing or rebuilding defective work regardless of whether Owner has benefited from use of work through portion of its anticipated useful service life.

2.10.7 Warranty for labor and materials required by the Contract Documents shall have their warranty period begin on the date of Substantial Completion for a period of one (1) year or as covered by special warranties, whichever is longer. The Design-Builder shall provide any and all technical support necessary to provide oversight, training and coordination of Owner personnel who perform the maintenance for installations performed under these specifications such that the Warranty durations specified in those sections and elsewhere in the Contract Documents will not begin until Substantial Completion of the Project . All arrangements required to be made with any supplier shall be made by the Design-Builder.

2.10.8 The Design-Builder shall replace or repair any such defective work in a manner satisfactory to Owner, after notice to do so from Owner and within the time specified in the notice.

2.10.9 Expressed warranties made to Owner are in addition to implied warranties and shall not limit duties, obligations, rights, and remedies otherwise available under law. Expressed warranty periods shall not be interpreted as limitations on time in which Owner can enforce such other duties, obligations, rights, or remedies.

2.10.10 Expressed warranties made to Owner shall not deprive Owner of other rights Owner may have under other provisions of Contract Documents and are in addition to and run concurrent with other warranties made by Design-Builder under requirements of Contract Documents.

2.10.11 Rejection of Warranties: Owner reserves right to reject warranties and to limit selection to products with warranties not in conflict with requirements of Contract Documents.

2.10.12 Where Contract Documents require special warranty, or similar commitment on work or part of work, Owner reserves right to refuse to accept work, until Design-Builder presents written evidence that entities required to countersign such commitments have done so or are willing to do so.

2.10.13 Warranty Submittals: Submit written warranties to Owner prior to date certified for Substantial Completion, or prior to the date that the warranty for a completed element of work begins.

2.10.14 When Contract Documents require Design-Builder, or Design-Builder and subcontractor, supplier or manufacturer to execute special warranty, prepare written document that contains appropriate terms and identification, ready for execution by required parties. Submit draft to Owner, for approval prior to final execution.

2.10.15 Form of Submittal: : At Substantial Completion or prior to the date that the warranty for a completed element of work begins, compile two (2) copies of each required warranty properly organized and executed by Design-Builder, or by Design-Builder, subcontractor, supplier, or manufacturer.

2.11 Correction of Non-Conforming Work

2.11.1 Design-Builder agrees to correct any Work that is found to not be in conformance with the Contract Documents, including that part of the Work subject to Section 2.10 hereof, within a period of one year from the date of Substantial Completion of the Work, or within one year after the date that the warranty for a completed element of work begins, or within such longer period to the extent required by any specific warranty included in the Contract Documents.

2.11.2 Design-Builder shall, within seven (7) days of receipt of written notice from Owner that the Work is not in conformance with the Contract Documents, take meaningful steps to commence correction of such nonconforming Work, including the correction, removal or replacement of the nonconforming Work and any damage caused to other parts of the Work affected by the nonconforming Work. If Design-Builder fails to commence the necessary steps within such seven (7) day period, Owner, in addition to any other remedies provided under the Contract Documents, may provide Design-Builder with written notice that Owner will commence correction of such nonconforming Work with its own forces. If Owner does perform such corrective Work, Design-Builder shall be responsible for all reasonable costs incurred by Owner in performing such correction. If the nonconforming Work creates an emergency requiring an immediate response, the seven (7) day period identified herein shall be deemed inapplicable.

2.11.3 The one-year period referenced in Section 2.10 above applies only to Design-Builder's obligation to correct nonconforming Work and is not intended to constitute a period of limitations for any other rights or remedies Owner may have regarding Design-Builder's other obligations under the Contract Documents.

2.12 Construction Coordination and Schedule

2.12.1 General

A. Administrative and procedural requirements for planning, monitoring, and documenting the progress of construction during performance of the Work, including the following:

1. 60-day startup construction schedule;
2. Contractor's Construction Schedule; and
3. Construction Progress Schedule reports.

2.12.2 Definitions

A. Activity: A discrete part of a project that can be identified for planning, scheduling, monitoring, and controlling the construction project. Activities included in a construction schedule consume time and resources.

1. Critical Activity: An activity on the critical path that must start and finish on the planned early start and finish times.
2. Predecessor Activity: An activity that precedes another activity in the network.
3. Successor Activity: An activity that follows another activity in the network.

B. Cost Loading: The allocation of the schedule of values for the completion of an activity as scheduled. The sum of costs for all activities must equal the total Contract Sum unless otherwise accepted by the Owner.

C. CPM: Critical path method, which is a method of planning and scheduling a construction project where activities are arranged based on activity relationships. Network calculations determine when activities can be performed and the critical path of Project.

D. Critical Path: The longest connected chain of interdependent activities through the network schedule that establishes the minimum overall Project duration and contains no float.

E. Day: Calendar Day unless specifically noted as Work Day.

F. Event: The starting or ending point of an activity.

G. Float: The measure of leeway in starting and completing an activity.

1. Float time is not for the exclusive use or benefit of either District or Contractor, but is a jointly owned, expiring Project resource available to both parties as needed to meet schedule milestones and Contract completion date.
2. Free float is the amount of time an activity can be delayed without adversely affecting the early start of the successor activity.
3. Total float is the measure of leeway in starting or completing an activity without adversely affecting the planned Project completion date.
4. Use of float suppression techniques such as software constraints, preferential sequencing, special lead/lag logic restraints, extended activity times, or imposed

dates, other than as required by the Contract, shall be cause for the rejection of any schedule submitted by the Contractor.

H. Fragnet: A fragnet is defined as the sequence of new activities that are proposed to be added to the existing schedule. The fragnet shall identify the predecessors to the new activities and demonstrate the impacts to successor activities. A fragnet may be inserted into the Construction Schedule to estimate a delay, if any.

I. Resource Loading: The allocation of manpower and equipment necessary for the completion of an activity as scheduled.

2.12.3 Submittals

A. Submittals shall include shop drawings and a schedule for delivery, including fabrication time.

B. Format for Submittals: Submit required submittals in the following format:

1. PDF electronic schedule file.
2. Working electronic copy of schedule file.
3. PDF file of narrative reports.

C. Submit a startup construction schedule within 15 days after receipt of the Owner's Notice to Proceed for Phase 2 Services, submit a preliminary schedule indicating planned operations during first 60 days of Phase 2.

1. Include cost of activities expected to be completed before submission and acceptance of the complete schedule.
2. Acceptance of cost-loaded, construction startup schedule will not constitute acceptance of schedule of values for cost-loaded activities.
3. The startup schedule shall include a schedule for the procurement of materials and equipment and a schedule for Submittals.

D. Submit a complete Contractor's Construction Schedule (Baseline) in compliance with Section 2.12.6 with a network diagram within 30 days after receipt of the Owner's Notice to Proceed for Construction Services. Show the complete network analysis system with logic ties for all major activities.

1. Size: as required to display entire network for entire construction period.
2. This schedule submittal will be reviewed by the Owner and returned to the Design-Builder within thirty (30) Days after submission. After receipt of review comments, Design-Builder shall resubmit a mutually acceptable system.

E. Submit a working electronic copy Contractor's Construction Schedule using software indicated in this Section, and labeled to comply with requirements for submittals. Provide hard copy in size able to display entire schedule for entire construction period.

F. Submit each of the reports listed following concurrent with CPM schedule. For each activity in reports include activity number, activity description, cost, original duration, remaining duration, early start date, early finish date, late start date, late finish date, and total float in calendar days.

1. Activity Report: List of all activities sorted by activity number and then early start date, or actual start date if known.
2. Logic Report: List of preceding and succeeding activities for all activities, sorted in ascending order by activity number and then early start date, or actual start date if known.
3. Total Float Report: List of all activities sorted in ascending order of total float.
4. Earnings Report: Compilation of Contractor's total earnings from the Notice to Proceed until most recent Application for Payment.
5. Critical path layout and report.

G. Submit a Narrative Report with each schedule submittal describing the following:

1. Project duration and variation from schedule;
2. Schedule status;
3. Milestone summary;
4. Critical Path Analysis;
5. Schedule progress;
6. Started, in-progress, and completed activities;
7. Change Notices and RFI's;
8. Delays and Impacts;
9. Weather conditions;
10. Progress photos.

H. Submit updated CPM Construction Progress Schedule with each Application for Payment indicating progress on all activities and implications on overall schedule. Construction Progress Schedule (monthly schedule update) is meant to only monitor the actual progress of work relative to the approved Baseline Schedule. It is not a substitute to the approved Baseline Schedule. Any schedule update that changes logic and duration or Contract Completion Date of the approved Baseline Schedule is not acceptable. Approved Baseline Schedule shall only be revised or superseded by a duly executed Revised Baseline Schedule Change Order.

I. Submit Recovery Schedule when periodic update indicates the Work is 14 or more calendar days behind the current accepted schedule, indicating means by which Contractor intends to regain compliance with the schedule.

1. The Contractor shall take all necessary measures to make up for such delay either by increasing staff, plant or facilities, or by amending its Work methods, whichever is applicable, with no change to the Contract Price.
2. Indicate changes to working hours, working days, crew sizes, and equipment required to achieve compliance, and date by which recovery will be accomplished.

2.12.4 Quality Assurance:

A. Comply with the requirements specified in the Contract Documents for Quality Assurance and Quality Control Requirements.

B. Scheduler Qualifications: An experienced scheduler in CPM scheduling and reporting, with capability of producing CPM reports and diagrams within 24 hours of Owner's request.

C. Preconstruction Conference: Refer to Section 2.1.16.. Review methods and procedures related to the preliminary construction schedule and Contractor's construction schedule, including the following:

1. Review software limitations and content and format for reports.
2. Verify availability of qualified personnel needed to develop and update schedule.
3. Discuss scheduling and critical path, constraints, including phasing, interim milestones and maintaining District water deliveries.
4. Review delivery dates for District-furnished products.
5. Review schedule for work of District's separate contracts.
6. Review submittal requirements and procedures.
7. Review time required for review of submittals and resubmittals.
8. Review requirements for tests and inspections by independent testing and inspecting agencies.
9. Review time required for Project closeout and District startup and commissioning activities.
10. Review and finalize list of construction activities to be included in schedule.
11. Review procedures for updating schedule.
12. Review site safety, security, site access, operation hours, environmental monitoring, permits and requirements.

2.12.5 Coordination:

A. The Contractor has the obligation and responsibility at all times to plan and monitor all of its activities, anticipating and scheduling its staff, subcontractors at all tiers, materials, plant and Work methods in a manner that is likely to ensure completion of the Work in accordance with the terms and conditions of the Contract.

B. Contractor will coordinate preparation and processing of schedules and reports with performance of construction activities and with scheduling and reporting of separate contractors. Contractor must notify Owner when equipment of components arrive, or are expected to arrive; their assistance may be needed in uncrating or exposing materials for inspection.

C. Coordinate Contractor's Construction Schedule with the Schedule of Values, submittal schedule, progress reports, payment requests, and other required schedules and reports.

1. Secure time commitments for performing critical elements of the Work from entities involved.
2. Coordinate each construction activity in the network with other activities and schedule them in proper sequence.

D. The Contractor must have the scheduler onsite regularly or in collaboration with someone onsite. The Project Manager or Project Engineer can serve this role for the Contractor.

2.12.6 Contractor's Construction Schedule:

A. Time Frame: Extend schedule from date established for Notice to Proceed for Phase 2 to date of Substantial Completion.

1. Contract completion date shall not be changed by submission of a schedule that shows an early completion date, unless specifically authorized by Change Order.

B. Activities: Establish a separate numbered activity for each main element of the Work. Comply with the following:

1. Activity Duration: Define activities so no activity is longer than 20 days, unless specifically allowed by Owner. The durations shall be determined based upon resource planning under contractually-defined on-site work conditions. The Owner may require that the duration of major activities be calculated by the scheduling software based on of the planned rate of daily production. In calculating activity durations, normal inclement weather shall be considered.

2. Critical Path Activities: Include procurement process activities for long lead items and major items, requiring a cycle of more than 60 days, as separate activities in schedule. Critical path cycle activities include, but are not limited to, submittals, acceptance, purchasing, fabrication, and delivery.

3. Submittal Review Time: Include review and resubmittal times indicated in Submittal Requirements in accordance with the Design Criteria Report, in schedule. Coordinate submittal review times in Contractor's construction schedule with submittal schedule. Contractor must submit all submittals 90 days prior to startup to allow for review and approval by the Owner, unless another time frame is specified elsewhere in the Contract Documents.

4. Startup and Testing Time: Include no fewer than 30 days for startup and testing. Include a pre-commissioning meeting to discuss plan with the Owner 3 to 6 months before startup and testing is scheduled to begin.

5. Substantial Completion: Indicate completion in advance of date established for Substantial Completion, and allow no fewer than 30 days for Owner's administrative procedures necessary for certification of Substantial Completion.

6. Punch List and Final Completion: Include not more than 45 days for completion of punch list items and final completion.

C. Constraints: Include constraints and work restrictions indicated in the Contract Documents and as follows in schedule, and show how the sequence of the Work is affected.

1. Phasing: Arrange list of activities on schedule by phase.

2. Products Ordered in Advance: Include a separate activity for each product, including delivery dates. Delivery dates should stipulate the earliest possible delivery date.

3. Work Restrictions: Show the effect of the following items on the schedule:

- (a) Coordination with existing construction;
- (b) Limitations of continued occupancies;
- (c) Uninterruptible services;
- (d) Partial occupancy before Substantial Completion;
- (e) Use of premises restrictions;
- (f) Provisions for future construction;
- (g) Seasonal variations and inclement weather;
- (h) Environmental control/ permitting;
- (i) Specified work sequences and constraints; and
- (j) Site access, security, and rights of adjacent neighbors.

4. Work Stages: Indicate important stages of construction for each major portion of the Work, including, but not limited to, the following:

- (a) Subcontract awards;
- (b) Submittals;
- (c) Purchases;
- (d) Mockups;
- (e) Fabrication;
- (f) Sample testing;
- (g) Deliveries;
- (h) Installation;
- (i) Functional testing;
- (j) Start-up;
- (k) Commissioning;
- (l) Performance testing;
- (m) Training;
- (n) Tests and inspections;

- (o) Adjusting;
- (p) Curing;
- (q) Startup and placement into final use and operation;
- (r) Project closeout and final cleaning; and
- (s) Demobilization.

5. Construction Areas: Identify each major area of construction for each major portion of the Work. Indicate where each construction activity within a major area must be sequenced or integrated with other construction activities to provide for the following:

- (a) Earthworks and excavation;
- (b) Structural completion;
- (c) Completion of mechanical installation;
- (d) Completion of electrical and instrumentation installation;
- (e) Completion of SCADA integration;
- (f) Functional testing;
- (g) Start-up;
- (h) Commissioning;
- (i) Performance testing;
- (j) Training; and
- (k) Substantial Completion.

6. Other constraints and Work Restrictions.

D. Milestones: Include milestones indicated in the Contract Documents in schedule, including, but not limited to, the Notice to Proceed, proposed Shutdowns, Substantial Completion, and Final Completion, and the appropriate interim milestones.

E. Computer Scheduling Software: Prepare schedules using current version of a program that has been developed specifically to manage construction schedules.

1. Use Primavera P6.

2. Settings: The Contractor is required to provide to the Owner all of the software settings it has used in the baseline schedules and updates. Examples of the information required are: Calendar settings, User Preferences, Administrative Preferences, Schedule Settings, etc.

3. Contractor must incorporate separate calendars as appropriate to identify all tasks subject to permits and work restrictions described in the specifications.

F. Contract Modifications:

1. For each proposed contract modification that may impact the overall schedule, prepare a time-impact analysis using a network fragnet to demonstrate the effect of the proposed change on the overall project schedule. Logically connect approved Contract changes into the CPM schedule. Each change will be identified by number and description, and activities/milestones will be added to record the following:

- (a) Date the change was identified;
- (b) Date the change was priced (if applicable); and
- (c) Start and finish dates of the changed Work.

2. Extensions of the Contract Times must be substantiated by a complete schedule demonstration showing the cause and effect of the relevant issue on the then-current critical path.

3. Contract modification proposals must be submitted by the contractor within 5 working days or the next weekly meeting. Contract modification proposals must be submitted in writing and documented via email or letter.

G. Initial Issue of Schedule: Prepare initial network diagram from a sorted activity list indicating straight "early start-total float." Identify critical activities. Prepare tabulated reports showing the following:

- 1. Contractor or subcontractor and the Work or activity;
- 2. Description of activity;
- 3. Main events of activity;
- 4. Immediately preceding and succeeding activities;
- 5. Early and late start dates;
- 6. Early and late finish dates;
- 7. Activity duration in workdays;
- 8. Total float or slack time;
- 9. Average size of workforce; and
- 10. Dollar value of activity (coordinated with the schedule of pay items).

H. Schedule Updating: The CPM Progress Schedule shall show the projected completion date of the Work based on the progress information inserted into it, without changes to the schedule logic or the original duration of any activity. The Contractor shall use the retained logic option when executing schedule calculation. The Contractor shall update the schedule monthly to reflect changes and show accurate timelines. Concurrent with making revisions to schedule, prepare tabulated reports showing the following:

- 1. Identification of activities that have changed;

2. Changes in early and late start dates;
3. Changes in early and late finish dates;
4. Changes in activity durations in workdays;
5. Changes in the critical path;
6. Changes in total float or slack time; and
7. Changes in the Contract Time.

I. Value Summaries: Prepare two cumulative value lists, sorted by finish dates.

1. In first list, tabulate activity number, early finish date, dollar value, and cumulative dollar value.
2. In second list, tabulate activity number, late finish date, dollar value, and cumulative dollar value.
3. In subsequent issues of both lists, substitute actual finish dates for activities completed as of list date.
4. Prepare list for ease of comparison with payment requests; coordinate timing with progress meetings.

(a) In both value summary lists, tabulate "actual percent complete" and "cumulative value completed" with total at bottom.

2.12.7 Contractor's Look-Ahead Schedules:

A. Contractor will develop and maintain a detailed look-ahead schedule and follow the following procedures:

1. Contractor shall list all completed, in progress, and upcoming activities for previous week, the current week, and the next two weeks upcoming;
2. Contractor shall show significant activities with actual start and completion dates;
3. Contractor shall present the look-ahead schedule at the weekly progress meetings as described in Project Meetings.

2.12.8 Acceptance of Schedules:

1. Owner review and acceptance of schedules does not waive any contract requirements and does not relieve the Design-Builder of any obligation or responsibility for submitting complete and accurate information.
2. If the Design-Builder fails to submit any of the schedule submittals, or to meet the scheduling requirements, including but not limited to update requirements, for a period of thirty (30) Days or more beyond the required submittal date, progress payments may be withheld until such time as the Design-Builder submits the required scheduling submittals in compliance with the Contract Documents.

Article 3

Owner's Services and Responsibilities

3.1 Duty to Cooperate

3.1.1 Owner shall, throughout the performance of the Work, cooperate with Design-Builder and perform its responsibilities, obligations and services.

3.1.2 In accordance with the Design Criteria Report, Owner, within 30 days, shall review and either approve or reject and state reasons for such rejection interim design submissions and Construction Documents. On items resubmitted after rejection, Owner shall also be provided 30 days to review the resubmittal and either approve or reject and state reasons for such rejections.

3.1.3 Owner shall give Design-Builder timely notice of any Work that Owner notices to be defective or not in compliance with the Contract Documents.

3.2 Furnishing of Services and Information

3.2.1 Notwithstanding the provision of certain documents from the Owner, The Design-Builder shall investigate the Project Site to ascertain conditions affecting necessary procedure and sequence of work operations for execution of the Contract, and to ascertain Project Site conditions, character, quality and quantity of surface and subsurface materials that will be encountered. The Design-Builder shall verify all dimensions in the field and shall check field conditions continuously during construction. Owner assumes no responsibility whatsoever in respect to the Design-Builder's interpretation of subsurface investigations. There is no guarantee or warranty, either expressed or implied, that conditions indicated in the Contract Documents, are representative of those existing throughout the Work, or any part of it, or that unexpected developments may not occur.

3.2.2 All soil and test hole data, groundwater elevations, and soil analyses shown on the Plans or included in the Contract Documents apply only at the location of the test holes and to the depths indicated. Soil test reports for test holes which have been drilled are available for inspection at the office of Owner. Additional subsurface exploration may be performed by the Design-Builder at its own expense.

3.2.3 The indicated groundwater elevation is that which existed on the date specified in the data. It is the Design-Builder's responsibility to determine and allow for the groundwater elevation on the date the Work is performed. A difference in groundwater elevation between what is shown in the soil boring logs and what is actually encountered during construction will not be considered as a basis for extra work.

3.2.4 If discovery is made of items of archaeological or paleontological interest, the Design-Builder shall immediately cease excavation in the area of discovery and shall not continue until ordered by Owner. When resumed, excavation operations within the area of discovery shall be as directed by Owner. Discoveries which may be encountered may include, but not be limited to, dwelling sites, stone implementations or other artifacts, animal bones, human bones, and fossils.

3.2.5 Rights of entry for the Work will be provided by Owner pursuant to the Contract Documents. Unless otherwise provided in the Contract Documents, the Design-Builder shall make arrangements, pay for, and assume all responsibility for acquiring, using, and disposing of additional work areas and facilities that may be temporarily required to perform the Work. The Design-Builder shall indemnify and hold Owner harmless from all claims for damages caused by such actions.

3.3 Financial Information

3.3.1 Design-Builder shall cooperate with the reasonable requirements of Owner's lenders or other financial sources. Notwithstanding the preceding sentence, after execution of the Agreement Design-Builder shall have no obligation to execute for Owner or Owner's lenders or other financial sources any documents or agreements that require Design-Builder to assume obligations or responsibilities greater than those existing obligations Design-Builder has under the Contract Documents.

3.4 Owner's Representative

3.4.1 Owner's Representative shall be responsible for providing Owner-supplied information and approvals in a timely manner to permit Design-Builder to fulfill its obligations under the Contract Documents. Owner's Representative shall also provide Design-Builder with prompt notice if it observes any failure on the part of Design-Builder to fulfill its contractual obligations, including any errors, omissions or defects in the performance of the Work. Owner's Representative shall communicate regularly with Design-Builder and shall be vested with the authority to act on behalf of Owner.

3.5 Government Approvals and Permits

3.5.1 Owner shall obtain and pay for all necessary permits, approvals, licenses, government charges and inspection fees set forth in the *Permits and Approvals*, attached as Exhibit E to the Agreement.

3.5.2 Owner shall provide reasonable assistance to Design-Builder in obtaining those permits, approvals and licenses that are Design-Builder's responsibility.

3.6 Owner's Other Contractors

3.6.1 Subject to the Design-Builder's coordination responsibilities of Other Contractors pursuant to Article 2.1.9, Owner is responsible for all work performed on the Project or at the Site by Other Contractors under Owner's control. In addition to Design-Builder's coordination obligations, Owner shall assist the Design-Builder and request that Other Contractors cooperate with, and coordinate their activities so as to enable Design-Builder to timely complete the Work consistent with the Contract Documents.

Article 4

Hazardous Conditions and Differing Site Conditions

4.1 Hazardous Conditions

4.1.1 Except as otherwise permitted in the Contract Documents, the Design-Builder agrees to accept sole responsibility for full compliance with any and all applicable present and future rules, regulations, restrictions, ordinances, statutes, laws and/or other orders of any governmental entity regarding the use, storage, handling, distribution, processing and/or disposal of hazardous wastes, extremely hazardous wastes, hazardous substances, hazardous materials, hazardous chemicals, toxic chemicals, toxic substances, pollutants, contaminants, or other similarly regulated substances (hereinafter referred to as "hazardous substances") regardless of whether the obligation for such compliance or responsibility is placed on the Owner of the land, on the Owner of any improvements on the premises, on the user of the land, or on the user of the improvements. Said hazardous substances shall include, but shall not be limited to gasoline, diesel and other fuels, lubricating oils and solvents.

4.1.2 Except for claims arising from Owner's sole or active negligence or willful misconduct, the Design-Builder agrees that any damages, penalties or fines levied against Owner and/or the Design-Builder as a result of noncompliance with any of the above shall be the sole responsibility of the Design-Builder and, further, that the Design-Builder shall indemnify and pay and/or reimburse Owner for any damages, penalties or fines that Owner incurs, or pays, as a result of noncompliance with this General Condition.

4.1.3 In the case of any hazardous substance spill, leak, discharge or improper storage on the premises, or contamination of same, by action or inaction of the Design-Builder, or anyone directly or indirectly employed or under contract to the Design-Builder, the Design-Builder agrees to make, or cause to be made, any necessary repairs or corrective actions, as well as to clean up and remove any leakage, contamination or contaminated ground. In the case of any hazardous substance spill, leak, discharge or contamination caused in whole or part by the Design-Builder, or by any of its subcontractors, employees, or agents, which affects Owner's property, or property (ies) of Owner's tenant(s), the Design-Builder agrees to make, or cause to be made, any necessary repairs, or take corrective actions, to clean-up and remove any such spill, leakage or contamination to the extent required by applicable law or regulation.

4.1.4 If, after reasonable notice, the Design-Builder fails to repair, clean-up, properly dispose of, or take any other corrective action(s) as required by the Contract Documents, Owner may (but shall not be required to) take all steps it deems reasonably necessary to properly repair, clean-up or otherwise correct the condition(s) resulting from the spill, leak or contamination. Any such repair, clean-up or corrective action(s) taken by Owner shall be at Design-Builder's sole cost and expense, including any and all costs (including any administrative costs) which Owner incurs, or pays, as a result of any repair, clean-up or corrective action it takes.

4.1.5 If the Design-Builder installs or uses already installed underground storage tanks, pipelines or other improvements on the specified premises for the storage, distribution, use, treatment or disposal of any hazardous substances, the Design-Builder agrees, upon the expiration and/or termination of this Contract, to remove and/or clean up, at the sole option of Owner, the above-referred to improvements. Said removal and/or clean-up shall be at Design-Builder's sole cost and expense, and shall be undertaken and completed in full compliance with all federal, state and local laws and regulations, as well as in compliance with the reasonable directions of Owner. 4.1.6 Design-Builder shall promptly supply Owner with copies of all notices, reports, correspondence and submissions made by the Design-Builder to any governmental entity regarding any hazardous substance spill, leak, discharge or clean-up, including all tests results.

4.1.6 Notwithstanding the foregoing sections of this General Condition:

4.1.6.1 Design-Builder shall not be held responsible for the presence or remediation of asbestos, asbestos-related materials, or any other hazardous substance, in any form whatsoever, as such materials and substances are defined by the Environmental Protection Agency or any other public authority, found on any property or structure that is the subject of services performed by Design-Builder under the Contract.

4.1.6.2 The Design-Builder's obligation to remediate hazardous substances is limited to the Work identified in the Contract Documents. The Design-Builder has no obligation to identify, abate and/or remediate hazardous substances not directly affected by the Work; however, the Design-Builder will identify, abate and/or remediate hazardous substances not included in the scope of work as directed in writing by Owner.

4.1.6.3 The Design-Builder will be compensated for approved additional costs resulting from changes in regulations, restrictions, ordinances, statutes, laws and/or other orders of any governmental entity regarding the use, storage, handling, distribution, processing and/or disposal of hazardous wastes, extremely hazardous wastes, hazardous substances, hazardous materials, hazardous chemicals, toxic chemicals, toxic substances, pollutants, contaminants, or other similarly regulated substances.

4.1.6.4 Owner will retain title to all pre-existing hazardous substances removed as part of the Design-Builder's work, and title shall not transfer to the Design-Builder. Owner agrees to sign all manifests as Owner of all such pre-existing hazardous substances. Hazardous substances introduced onto the Project Site by the Design-Builder shall remain titled to the Design-Builder.

4.1.7 This General Condition and the obligation(s) contained therein, shall survive the expiration or earlier termination of this Contract.

4.2 Differing Site Conditions

4.2.1 Concealed or latent physical conditions or subsurface conditions at the Site that (i) materially differ from the conditions indicated in the Contract Documents or (ii) are of an unknown and unusual nature, differing materially from the conditions ordinarily encountered and generally recognized as inherent in the Work are collectively referred to herein as "Differing Site Conditions" The Design-Builder shall immediately, and before any of the following conditions are disturbed, notify Owner, first verbally and later within seven (7) days of the verbal notification, with a properly documented notice.

4.2.2 Owner shall investigate such conditions, and if it finds that such conditions do materially differ and could not have been discovered, or reasonably inferred, from the Contract Documents or a thorough inspection of the Project Site by the Design-Builder, and such conditions cause an impact to the Contract pricing, or Work Completion Time, Owner and Design-Builder shall promptly and in good faith negotiate a Change Order.

4.2.3 If the Design-Builder has not fully complied with the documentation and submittal requirements of the Contractor Potential Change Notice in accordance with the Contract, the Design-Builder shall be deemed to have waived its right to assert a claim for any adjustment to the Contract pricing, or Work Completion Time arising out of such differing Project Site conditions.

4.2.4 Should an agreement not be reached on a Change Order, pursuant to Article 9, the Owner may issue a Change Directive to have the Work performed. Such an Order is unilateral and the Work will be performed on a Time and Material basis. The Design-Builder shall be required to keep detailed records of all costs related to performing the Work and compensation for said work will be reconciled in a Change Order upon agreement of a lump sum price or completion of the Work, whichever occurs first.

Article 5

Insurance and Bonds

5.1 Design-Builder's Insurance Requirements

5.1.1 Design-Builder is responsible for procuring and maintaining the insurance for the coverage amounts all as set forth in the Insurance Exhibit H to the Agreement. Coverage shall be secured from insurance companies authorized to do business in the state in which the Project is located, and with a minimum rating set forth in the Insurance Exhibit H.

5.1.2 Design-Builder's insurance policies shall specifically delete any design-build or similar exclusions that could compromise coverage's because of the design-build delivery of the Project.

5.1.3 Prior to commencing any design and construction services hereunder, Design-Builder shall provide Owner with certificates and pertinent additional insured and other endorsements evidencing that (i) all insurance obligations required by the Contract Documents are in full force and in effect and will remain in effect for the duration required by the Contract Documents and (ii)

no insurance coverage will be canceled, renewal refused, or materially changed unless at least thirty (30) days prior written notice is given to Owner and all other insureds. If any of the foregoing insurance coverage's is required to remain in force after final payment, additional certificate(s) and endorsement(s) evidencing continuation of such coverage shall be submitted with the Final Application for Payment.

5.1.4 Owner and Design-Builder waive against each other and Owner's separate contractors, Design Consultants, Subcontractors, agents and employees of each and all of them, all damages covered by property insurance provided herein, except such rights as they may have to the proceeds of such insurance. Design-Builder and Owner shall, where appropriate, require similar waivers of subrogation from Owner's separate contractors, Design Consultants and Subcontractors and shall require each of them to include similar waivers in their contracts. These waivers of subrogation shall not contain any restriction or limitation that will impair the full and complete extent of its applicability to any person or entity unless agreed to in writing prior to the execution of this Agreement.

5.2 Bonds and Other Performance Security

5.2.1 The Design-Builder shall file surety bonds with Owner to be approved by the District and/or its counsel in the amount and for the purposes noted below. Bonds issued by a surety who is listed in the latest version of U.S. Department of Treasury Circular 570, who is authorized to issue bonds in California, and whose bonding limitation shown in said circular is sufficient to provide bonds in the amount required by the Contract. Bonds from all other sureties shall be accompanied by all of the documents enumerated in Code of Civil Procedure 995.660(a). The Design-Builder shall pay all bond premiums, costs, and incidentals.

5.2.2 The Design-Builder shall provide Payment and Performance bonds on forms provided by Owner. The "Payment Bond" (Material and Labor bond) shall be for 100 percent (100%) of the Contract price, as amended from time to time, to satisfy claims of material suppliers and mechanics and laborers employed by it on the Work.

5.2.3 The Performance Bond shall be for one hundred percent (100%) of the Contract price as amended from time to time. The Design-Builder shall submit all bonds within fifteen (15) calendar days of the award of Contract.

5.2.4 Should any bond become insufficient, the Design-Builder shall renew the bond within 10 days after receiving notice from Owner.

5.2.5 Should any surety at any time be unsatisfactory to the Owner, notice will be given the Design-Builder to that effect. No further payment shall be deemed due or will be made under the Contract until a new surety shall qualify and be accepted by the Owner.

5.2.6 Changes in the Work or extensions of time made pursuant to the Contract shall in no way release the Design-Builder or surety from its obligations. Notice of such changes or extensions shall be waived by the surety.

Article 6

Payment

6.1 Schedule of Values

6.1.1 Unless required by the Owner upon execution of this Agreement, within ten (10) days of execution of the Agreement, Design-Builder shall submit for Owner's review and approval a schedule of values for all of the Work. The Schedule of Values will (i) subdivide the Work into its respective parts, (ii) include values for all items comprising the Work and (iii) serve as the basis for monthly progress payments made to Design-Builder throughout the Work.

6.1.2 The Owner will be provided 14 days to review and either approve or reject with reasons stated the schedule of values so as not to delay the submission of the Design-Builder's first application for payment. If rejected, Design Builder shall promptly resubmit the schedule of values and provide Owner 7 days to review and either approve or reject with reasons stated the resubmittal.

6.2 Monthly Progress Payments

6.2.1 Design-Builder shall submit for Owner's review and approval its Application for Payment requesting payment for all Work performed as of the date of the Application for Payment. The format of the form will be agreed with the Owner. The Application for Payment shall be accompanied by all supporting documentation required by the Contract Documents, including but not limited to:

6.2.1.1 Unconditional releases of lien in the statutory form for all subcontractors and suppliers, through the prior payment application.

6.2.1.2 Actual invoices for materials and equipment must be submitted with the Application for Payment (for Change Orders and cost reimbursable contracts).

- i. Unless otherwise provided in the Contract Documents, up to eighty percent (80%) of the invoiced amount may be paid on account of materials and equipment delivered and suitably stored at the Project Site for subsequent incorporation in the Work, provided that (i) Owner is satisfied that the equipment and materials are suitably stored at either the Site or another acceptable location, (ii) the equipment and materials are protected by suitable insurance and (iii) upon payment, Owner will receive the equipment and materials free and clear of all liens and encumbrances. .
- ii. Notwithstanding section 6.2.1.2(i), payment will not be made for any materials or equipment unless each individual piece of the material or equipment becomes a permanent part of the Work or the material or equipment is required by the Contract Documents and is specifically manufactured for the Project and could not be readily utilized or diverted to another job. Actual invoices for materials and equipment must be submitted with the Application for Payment

6.2.1.3 Updated CPM Construction Progress Schedule

Failure to submit any of the supporting documentation shall be cause for the Application for Payment to be rejected by the Owner, in which case, the Design-Builder will be required to resubmit the Application Payment and supporting documentation.

6.2.2 Owner may withhold a payment in whole or in part to the extent reasonably necessary to protect Owner due to Owner's determination that the Work has not progressed to the point indicated in the Application for Payment or that the quality of work is not in accordance with the Contract Documents. Owner may also withhold a payment because of subsequently discovered evidence which may nullify the whole or a part of an Application for Payment previously issued to such extent as may be necessary to protect Owner from loss for which the Design-Builder is responsible.

6.2.3 Owner may refuse to make payment of the full amount of the Application for Payment to the extent reasonably necessary to protect Owner because:

6.2.3.1. claims have been made against Owner on account of Design Builder's performance or furnishing of the Work;

6.2.3.2. there are other items entitling Owner to a set-off against the amount recommended; or

6.2.3.3. Owner has actual knowledge of the occurrence of any of the events Defective Work or Termination for Cause

If Owner refuses to make payment of the full amount recommended by Owner or Owner's Representative, Owner shall give Design-Builder immediate written notice stating the reasons for such action and promptly pay Design-Builder any amount remaining after deduction of the amount so withheld. Owner shall promptly pay Design-Builder the amount so withheld, or any adjustment thereto agreed to by Owner and Design-Builder, when Design-Builder corrects to Owner's satisfaction the reasons for such action.

6.2.4 Rejection of Payment for Defective Work. The Owner's Representative may also refuse to recommend any such payment or, because of subsequently discovered evidence or the results of subsequent inspections or tests, nullify any such payment previously recommended, to such extent as may be necessary in the Owner's Representative opinion to protect Owner from loss because:

6.2.4.1 The work is defective, or completed work has been damaged requiring correction or replacement,

6.2.4.2. The Contract Price has been reduced by written amendment or Change Order,

6.2.4.3. The Owner has been required to correct defective work or complete work

6.2.4.4. The Owner has actual knowledge of the occurrence of any of the events justifying a Suspension or Termination for Cause.

6.2.5 Not Used.

6.2.6 Where Allowances have been used, the Design-Builder may be paid for Allowance items on either a cost reimbursable or lump sum basis. The Design-Builder's mark-up shall be all-inclusive of supervision and coordination and no additional compensation shall be allowed. An Allowance shall not be considered a change for the purposes of granting time extensions. Unused portions of a stipulated Allowance will not be paid to the Design-Builder and shall be deducted from the contract value at the completion of the Project via a deductive Change Order.

6.2.8 The Application for Payment shall constitute Design-Builder's representation that the Work described herein has been performed consistent with the Contract Documents, has progressed to the point indicated in the Application for Payment, and that title to all Work will pass to Owner free and clear of all claims, liens, encumbrances, and security interests upon the incorporation of the Work into the Project, or upon Design-Builder's receipt of payment, whichever occurs earlier.

6.2.9 The Application for Payment shall identify, as a sub-total, the amount of the Design-Builder's total earnings to date, plus the value of materials stored at the Site which have not yet been incorporated in the Work, less a deductive adjustment for materials previously paid for by the Owner. Payment for such material shall not be construed as acceptance of the material.

6.3 Withholding of Payments

6.3.1 On or before the date established in the Agreement, subject to the Retention provisions, Owner shall pay Design-Builder all amounts properly due. If Owner determines that Design-Builder is not entitled to all or part of an Application for Payment as a result of Design-Builder's failure to meet its obligations hereunder, it will notify Design-Builder. The notice shall indicate the specific amounts Owner intends to withhold, the reasons and contractual basis for the withholding, and the specific measures Design-Builder must take to rectify Owner's concerns. Design-Builder and Owner will attempt to resolve Owner's concerns.

6.3.2 Notwithstanding anything to the contrary in the Contract Documents, Owner shall pay Design-Builder all undisputed amounts in an Application for Payment within the times required by the Agreement.

6.4 Design-Builder's Payment Obligations

6.4.1 Design-Builder will pay Design Consultants and Subcontractors, in accordance with its contractual obligations to such parties. Design-Builder will impose similar requirements on Design Consultants and Subcontractors to pay those parties with whom they have contracted. Design-Builder will indemnify and defend Owner against any claims for payment, stop payment notices, and mechanic's liens as set forth in Section 7.3 hereof.

6.5 Substantial Completion

6.5.1 Design-Builder shall notify Owner when it believes the Work, or to the extent permitted in the Contract Documents, a portion of the Work, is Substantially Complete. Within five (5) days of Owner's receipt of Design-Builder's notice, Owner and Design-Builder will jointly inspect such Work to verify that it is Substantially Complete in accordance with the requirements of the Contract Documents. If such Work is Substantially Complete, Owner shall prepare and issue a Certificate of Substantial Completion that will set forth (i) the date of Substantial Completion of the Work or portion thereof, (ii) the remaining items of Work that have to be completed before final payment, (iii) provisions (to the extent not already provided in the Contract Documents) establishing Owner's and Design-Builder's responsibility for the Project's security, maintenance, utilities and insurance pending final payment, and (iv) an acknowledgment that warranties commence to run on the date of Substantial Completion, except as may otherwise be noted in the Certificate of Substantial Completion. The Certificate of Substantial Completion shall not relieve the Design-Builder of the responsibility to complete all work in accordance with the Contract Documents. Failure to include any items on the punch list shall not alter the responsibility of the Design-Builder to complete all Work in accordance with the Contract Documents.

6.5.2 Substantial Completion occurs when all of the following conditions have been met:

6.5.2.1 The Design-Builder has submitted and Owner has approved in writing, such approval not to be unreasonably withheld, a certification by the Design-Builder and the lead Design Firm that construction of the Project, excepting the items on the Final Punch List, is complete and in all respects is in compliance with this Agreement.

6.5.2.2 A preliminary or temporary certificate of occupancy has been issued for the Project, where required by applicable law

6.5.2.3 The Design-Builder has delivered to Owner a red-lined set of “as-built” construction record drawings as required by the Contract Documents

6.5.2.4 All Utilities specified or required under this Agreement to be arranged for by the Design-Builder are connected and functioning properly

6.5.2.5 Design-Builder has successfully completed start-up, commissioning and performance testing and has additionally provided the required training to the Owner along with all operational and maintenance manuals.

6.5.2.6 The Design-Builder and Owner have agreed in writing upon the Final Punch List (or, if they are unable to agree, Owner shall have prepared and issued the Final Punch List to the Design-Builder within 15 business days of the Design-Builder having submitted its proposed Final Punch List to Owner)

6.5.2.7 The Design-Builder has delivered to Owner written certification from the equipment manufacturers (including information technology systems and instrumentation and controls) that all major items of machinery and equipment included in the Project have been properly installed, performance tested, and commissioned in accordance with the manufacturers’ recommendations, warranties, and requirements

6.5.2.8 The Design-Builder has submitted written certification that all of the foregoing conditions have been satisfied and Owner has approved the Design-Builder’s certification, which approval shall be effective as of the date of the Design-Builder’s certification.

6.5.3 Upon Substantial Completion of the entire Work or, if applicable, any portion of the Work, Owner may at its sole discretion per DBIA Agreement No. 545, Section 8.3 release to Design-Builder portions of the retained amounts relating, as applicable, to the entire Work or completed portion of the Work, less an amount equal to the reasonable value of all remaining or incomplete items of Work as noted in the Certificate of Substantial Completion.

6.5.4 Owner, at its option, may use a portion of the Work which has been determined to be Substantially Complete, provided, however, that (i) a Certificate of Substantial Completion has been issued for the portion of Work addressing the items set forth in Section 6.5.1 above, (ii) Design-Builder and Owner have obtained the consent of their sureties and insurers, and to the extent applicable, the appropriate government authorities having jurisdiction over the Project, and (iii) Owner and Design-Builder agree that Owner’s use or occupancy will not interfere with Design-Builder’s completion of the remaining Work.

6.6 Final Completion and Final Payment

6.6.1 When the Design-Builder considers that the Work is complete and ready for final inspection, it shall submit a Notice of Final Completion to Owner for inspection with certification that:

6.6.1.1 Work has been completed in accordance with Contract Documents and Certificate of Occupancy issued.

6.6.1.2 Work has been inspected by the Design-Builder for compliance with Contract Documents and all Punch List work has been completed.

6.6.1.3 All damaged or destroyed real, personal, public or private property has been repaired or replaced.

6.6.1.4 All required as-builts and close out documents have been submitted and accepted.

6.6.1.5 All warranties have been submitted and accepted and all training and commissioning has been completed.

6.6.1.6 Work is ready for final inspection by Owner.

6.6.2 Owner will inspect to verify the status of completion with reasonable promptness after receipt of such certifications. The inspection of the Work will be done in accordance with the Contract provisions.

6.6.3 If Owner finds incomplete or defective work:

6.6.3.1 Owner may, at Owner's sole discretion, either terminate the inspection or prepare a punch list and notify the Design-Builder in writing, listing incomplete or defective work.

6.6.3.2 The Design-Builder shall take immediate steps to remedy stated deficiencies. Upon completion and correction of all stated deficiencies, the Design-Builder shall send a subsequent written certification to Owner that work is complete.

6.6.3.3 Owner will then re-inspect the Work.

6.6.3.4 Owner may, at Owner's sole discretion, have a separate contractor make corrections and deduct the cost of the corrections from the Design-Builder's final payment if the work is not promptly corrected.

6.6.4 Final Acceptance

6.6.4.1 Within 120 days after Substantial Completion, and after Design-Builder has reached Final Completion and has made written request for final inspection, Owner will perform final inspection and if Owner is satisfied that the Work has been completed in accordance with the Agreement, and is satisfied that all submittals have been made and accepted, all as-builts and record documents have been completed and accepted, all Change Orders executed, all final quantities agreed to, and all other Contract requirements, except for possible future warranty and guarantee work have been accomplished, Owner shall issue a document evidencing Final Acceptance.

6.6.4.2 If Owner finds the Work to be complete, Owner will issue a letter of Final Acceptance to the Design-Builder.

6.6.4.3 The Work shall be under the charge and care of the Design-Builder until Owner issues the letter of Final Acceptance unless otherwise approved by Owner. The Design-Builder shall take every precaution against injury or damage to the Work from the action of the elements or any other cause, whether arising from the execution or non-execution of the Work. The Design-Builder shall rebuild, repair, restore, and make good, at the Design-Builder's expense, all injuries or damage to the Work occurring before acceptance of the Work.

6.6.5 Upon issuance of a letter of Final Acceptance, the Design-Builder shall submit a Final Application for Payment, and Owner shall make final payment by the time required in the Agreement, provided that Design-Builder has achieved Final Completion.

6.6.6 At the time of submission of its Final Application for Payment, Design-Builder shall provide the following information:

6.6.6.1 An affidavit that there are no claims, obligations or liens outstanding or unsatisfied for labor, services, material, equipment, taxes or other items performed, furnished or incurred for or in connection with the Work which will in any way affect Owner's interests;

6.6.6.2 A general release executed by Design-Builder waiving, upon receipt of final payment by Design-Builder, all claims, except those claims previously made in writing to Owner and remaining unsettled at the time of final payment;

6.6.6.3 Consent of Design-Builder's surety, if any, to final payment;

6.6.6.4 All operating manuals, warranties and other deliverables required by the Contract Documents; and

6.6.6.5 Certificates of insurance confirming that required coverage's will remain in effect consistent with the requirements of the Contract Documents.

6.6.7 Upon making final payment, Owner waives all claims against Design-Builder except claims relating to (i) Design-Builder's failure to satisfy its payment obligations, if such failure affects Owner's interests, (ii) Design-Builder's failure to complete the Work consistent with the Contract Documents, including defects appearing after Substantial Completion and (iii) the terms of any warranties required by the Contract Documents. After the date of Final Acceptance of the Work by Owner, no additional claims or change requests may be submitted by Design-Builder.

6.6.8 Deficiencies in the Work discovered after Substantial Completion, whether or not such deficiencies would have been included on the Punch List if discovered earlier, shall be deemed warranty Work. Such deficiencies shall be corrected by Design-Builder under Sections 2.10 and 2.11 herein, and shall not be a reason to withhold final payment from Design-Builder, provided, however, that Owner shall be entitled to withhold from the Final Payment the reasonable value of completion of such deficient work until such work is completed.

Article 7

Indemnification

7.1 Patent and Copyright Infringement

7.1.1 Design-Builder shall defend any action or proceeding brought against Owner based on any claim that the Work, or any part thereof, or the operation or use of the Work or any part thereof, constitutes infringement of any United States patent or copyright, now or hereafter issued. Owner shall give prompt written notice to Design-Builder of any such action or proceeding and will reasonably provide authority, information and assistance in the defense of same. Design-Builder shall indemnify and hold harmless Owner from and against all damages and costs, including but not limited to attorneys' fees and expenses awarded against Owner or Design-Builder in any such action or proceeding. Design-Builder agrees to keep Owner informed of all developments in the defense of such actions.

7.1.2 If Owner is enjoined from the operation or use of the Work, or any part thereof, as the result of any patent or copyright suit, claim, or proceeding, Design-Builder shall at its sole expense take reasonable steps to procure the right to operate or use the Work. If Design-Builder cannot so procure such right within a reasonable time, Design-Builder shall promptly, at Design-Builder's option and at Design-Builder's expense, (i) modify the Work so as to avoid infringement of any such patent or copyright or (ii) replace said Work with Work that does not infringe or violate any such patent or copyright.

7.1.3 Sections 7.1.1 and 7.1.2 above shall not be applicable to any suit, claim or proceeding based on infringement or violation of a patent or copyright (i) relating solely to a particular process or product of a particular manufacturer specified by Owner and not offered or recommended by Design-Builder to Owner or (ii) arising from modifications to the Work by Owner or its agents after

acceptance of the Work. If the suit, claim or proceeding is based upon events set forth in the preceding sentence, Owner shall defend, indemnify and hold harmless Design-Builder to the same extent Design-Builder is obligated to defend, indemnify and hold harmless Owner in Section 7.1.1 above.

7.1.4 The obligations set forth in this Section 7.1 shall constitute the sole agreement between the parties relating to liability for infringement of violation of any patent or copyright.

7.2 Tax Claim Indemnification

7.2.1 If, in accordance with Owner's direction, an exemption for all or part of the Work is claimed for taxes, Owner shall indemnify, defend and hold harmless Design-Builder from and against any liability, penalty, interest, fine, tax assessment, attorneys' fees or other expenses or costs incurred by Design-Builder as a result of any action taken by Design-Builder in accordance with Owner's directive. Owner shall furnish Design-Builder with any applicable tax exemption certificates necessary to obtain such exemption, upon which Design-Builder may rely.

7.3 Payment Claim Indemnification

7.3.1 Provided that Owner is not in breach of its contractual obligation to make payments to Design-Builder for the Work, Design-Builder shall indemnify, defend and hold harmless Owner from any claims or mechanic's liens brought against Owner or against the Project as a result of the failure of Design-Builder, or those for whose acts it is responsible, to pay for any services, materials, labor, equipment, taxes or other items or obligations furnished or incurred for or in connection with the Work. Within three (3) days of receiving written notice from Owner that such a claim or mechanic's lien has been filed, Design-Builder shall commence to take the steps necessary to discharge said claim or lien, including, if necessary, the furnishing of a mechanic's lien bond. If Design-Builder fails to do so, Owner will have the right to discharge the claim or lien and hold Design-Builder liable for costs and expenses incurred, including attorneys' fees.

7.4 Design-Builder's General Indemnification

7.4.1 To the fullest extent permitted by law, Design-Builder shall defend, indemnify and hold harmless Owner and any and all of Owner's Council, Boards, officers, agents, employees, assigns and successors in interest from and against any and all suits, claims, causes of action, liability, losses, damages, demands or expenses (including, but not limited to, attorney's fees and costs of litigation), (collectively, "Loss") claimed by anyone (including Design-Builder and/or Design-Builder's agents or employees) by reason of injury to, or death of, any person(s) (including Design-Builder and/or Design-Builder's agents or employees), or for damage to, or destruction of, any property (including property of Design-Builder and/or Design-Builder's agents or employees) or for any and all other losses, founded upon or alleged to arise out of, pertain to, or relate to the Design-Builder's and/or subcontractor's performance of the Work on the Project, whether or not contributed to by any act or omission of Owner, or of any of Owner's Council, Boards, officers, agents or employees; Provided, however, that where such suits, claims, causes of action, liability, losses, damages, demands or expenses arise from or relate to Design-Builder's performance of a "Construction Contract" as defined by California Civil Code section 2783, this paragraph shall not be construed to require Design-Builder to indemnify or hold Owner harmless to the extent such suits, causes of action, claims, losses, demands and expenses are caused by the Owner's sole negligence, willful misconduct or active negligence; Provided further that where such suits, claims, causes of action, liability, losses, damages, demands or expenses arise from Design-Builder's design professional services as defined by California Civil Code section 2782.8, Design-Builder's indemnity obligations shall not include an up-front duty to defend and shall be limited to allegations, suits, claims, causes of action, liability, losses, damages, demands or expenses to the extent arising out of, pertaining to, or relating to the Design-Builder's negligence, recklessness or willful misconduct in the performance of the Agreement.

7.4.2 If an employee of Design-Builder, Design Consultants, Subcontractors, anyone employed directly or indirectly by any of them or anyone for whose acts any of them may be liable has a claim against Owner, its officers, directors, employees, or agents, Design-Builder's indemnity obligation set forth in Section 7.4.1 above shall not be limited by any limitation on the amount of damages, compensation or benefits payable by or for Design-Builder, Design Consultants, Subcontractors, or other entity under any employee benefit acts, including workers' compensation or disability acts.

7.4.3 Design-Builder's obligation to defend and indemnify the Owner and the other referenced indemnitees arises at the time such Loss is tendered to Design-Builder by the Owner and continues at all times until finally resolved, and/or decided by an adjudicatory body or a court of competent jurisdiction.

7.5 Owner's General Indemnification

7.5.1 Owner, to the fullest extent permitted by law, shall indemnify, hold harmless and defend Design-Builder and any of Design-Builder's officers, directors, and employees, from and against claims, losses, damages, liabilities, including attorneys' fees and expenses, for bodily injury, or death, and property damage or destruction (other than to the Work itself) but only in proportion to and to the extent resulting from the negligent acts or omissions of Owner, or Owner's employees or agents who are directly under Owner's authority or control (separate and distinct from Design-Builder or others under Design-Builder's authority or control) and for whose acts Owner may be liable.

7.6 Survival of Indemnities

7.6.1 The provisions of this Article 7 shall remain operative following a termination of all other performance under this Agreement unless specifically extinguished in a writing signed as approved by the Design-Builder, the Owner and its attorney.

Article 8

Time

8.1 Obligation to Achieve the Contract Times

8.1.1 Design-Builder agrees that it will commence performance of the Work and achieve the Contract Time(s) in accordance with Article 6 of the Agreement.

8.1.2 The Design-Builder shall be permitted reasonable, uninterrupted access to the Project Site subject to the operational protocols in place and as revised from time to time. The Design-Builder shall cooperate with Owner to reasonably accommodate Owner's other work on the Project Site. Design-Builder shall actively schedule plan and coordinate the sequence of the Work and shall not delegate such responsibility for coordination to subcontractors but rather shall actively and proactively schedule and lead subcontractor coordination.

8.1.3 The Design-Builder shall diligently prosecute the Work to completion. If Owner determines that the Design-Builder is failing to prosecute the Work in accordance with its approved schedule or the Project milestones, the Design-Builder shall immediately take steps to remedy the situation

8.1.4 All work performed and services provided hereunder by the Design-Builder shall conform to the standard of care ordinarily exercised by the construction industry in the State of California as applicable to a Design-Builder with prior successful experience in work similar in size and scope and complexity as the Work of the Contract Documents.

8.1.5 The Design-Builder shall give Owner full information in advance as to its plans for performing each part of its work. If at any time, Design-Builder's actual progress is inadequate to meet the requirements of this Agreement, Owner may so notify Design-Builder who shall thereupon take such steps as may be necessary to improve its progress. A Recovery Schedule is required along with the submission of a monthly Progress Schedule Update if the monthly Progress Schedule Update shows a delay of more than two (2) weeks to the Contract Milestones. If within a reasonable period as determined by Owner, the Design-Builder does not improve performance to meet the currently approved Construction Schedule; Owner may require an increase in the Design-Builder's labor force, the number of shifts, overtime operations, and additional days of work per week, all without additional cost to Owner. Neither such notice by Owner nor Owner's failure to issue such notice shall relieve Design-Builder of its obligation to achieve the quality of work and rate of progress required by this Agreement.

8.2 Delays to the Work

8.2.1 If Design-Builder is delayed in the performance of the Work due to acts, omissions, conditions, events, or circumstances beyond its control and due to no fault of its own or those for whom Design-Builder is responsible, subject to compliance with Section 2.12, the Contract Time(s) for performance may be reasonably extended by Change Order only to the extent that such delay impacts the critical path. Subject to section 8.3 and 9.5.4, an excusable delay is a delay to the critical path of the Project and meets all of the following requirements:

8.2.1.1 It was not the responsibility of the Design-Builder under the Contract Documents and was beyond the control of Design-Builder;

8.2.1.2 It could not have been foreseen or avoided by Design-Builder;

8.2.1.3 the extent of the delay claimed was not caused by Design-Builder, its subcontractors or agents;

8.2.1.4 Design-Builder has provided written notice to Owner of the delay act or event within seven (7) calendar days of its occurrence and thereafter satisfies all requirements in the Contract Documents for making a request for extension to the Project Schedules and Contract milestones. Pursuant to California Civil Code section 1511, the Parties agree that any failure to submit a timely and properly documented notice of delay or a request for extension of to the Project Schedules and Contract Milestones shall constitute a waiver by Design-Builder of any claim for additional compensation, time or impact costs from Owner.

8.2.2 In addition to Design-Builder's right to a time extension for those events set forth in Section 8.2.1 above, Design-Builder may be entitled to an appropriate adjustment of the Contract Price. A delay which is excusable must also meet the requirements for a compensable delay in order to be compensable. A Force Majeure delay is an excusable non-compensable delay. A delay due to financial issues of Design-Builder or any of its subcontractors or suppliers, including bankruptcy or insolvency, is not an excusable delay. A non-excusable delay is also non-compensable. A compensable delay must be excusable and meet all of the following requirements:

8.2.2.1 The costs of delay requested could not be mitigated;

8.2.2.2 It was a result of a change directed by Owner, a material breach of the Agreement by Owner or resulting from the active negligence of Owner or other parties under Owner's control;

8.2.2.3 The Contract Documents do not preclude the claim for compensation;

8.2.2.4 The delay is not concurrent with a delay caused by Design-Builder;

8.2.2.5 Design-Builder has satisfied all requirements in the Contract Documents for making a claim for compensation pursuant to a compensable delay in a timely manner.

8.2.3 If the Contractor Change Request is based in whole or in part on a delay of any kind or nature, the complete itemized proposal shall include the following information in addition to all other required information:

8.2.3.1 The date, nature and circumstances of each event regarded as a cause of the delay;

8.2.3.2 If the Design-Builder claims acceleration costs of scheduled performance or delivery, the basis upon which acceleration arose;

8.2.3.3 The identification of any documents and the substance of any oral communication known to the Design-Builder which substantiate, refute or concern such delay;

8.2.3.4 A Critical Path Method (CPM) schedule, including design, construction and commissioning corrected to reflect actual performance, showing delay impacts as separate tasks and Design-Builder's mitigation of such impacts; and

8.2.3.5 The specific elements of Contract performance for which the Design-Builder may seek an equitable adjustment, including:

- i. Identification of each Contract or schedule line item which has been or may be affected by such delay;
- ii. To the extent practicable, identification of the delay and disruption in the manner and sequence of performance, and the effect on continued performance, which have been or may be caused by such delay;
- iii. Identification of labor, materials, or both, or other cost items including overhead and subcontractor costs, which have been or may be added, deleted or wasted by such delay, and a statement that the Design-Builder is maintaining records by some generally accepted accounting procedure which allows the separately identifiable direct costs due to the delay, and those not incurred as a result of the delay, to be readily identified and segregated; and
- iv. Estimates of the necessary adjustments to Contract Amount, Contract Time and any other Contract provisions affected by the delay.

8.2.4 Claims for a compensable delay shall not be allowed for any costs incurred if the Design-Builder fails to notify Owner in writing within seven (7) calendar days of the act or event causing the delay. The Design-Builder will have the burden of proving that the delay is both an excusable delay and a compensable delay. If an excusable delay is found to be a compensable delay, Owner will by Change Order extend the Work Completion Time for the increase in the time of performance and will adjust the total Contract Price. The Change Order will be the Design-Builder's sole remedy arising out of the compensable delay. Pursuant to California Civil Code section 1511, the Parties agree that any failure to submit a timely and properly documented notice of excusable or compensable delay shall constitute a waiver by Design-Builder of any claim for additional compensation, time or impact costs from Owner.

8.3 Force Majeure

8.3.1 The term "Force Majeure" as employed herein shall mean an excusable, non-compensable delay which is one of the below listed types, to the extent that the event(s) delays the progress of

critical path activities, are beyond the Design-Builder's control, were not anticipatable by Design-Builder: acts of God (except as excluded herein), strikes (except those determined by Owner to be within the control of the Design-Builder), lockouts, or other industrial disturbances, acts of public enemies, terrorist acts, wars, blockades, insurrections, riots, epidemics, pandemics, earthquakes, hurricanes, tornadoes, orders by any court, board, department, commission or city or county of the United States or of any State, civil disturbances, explosions, rain or other adverse weather conditions, including fire (except fire which was the responsibility of the Design-Builder).

8.3.2 The Design-Builder's observance of non-sanctioned picket lines or other similar labor actions shall be considered a non-excusable delay under this Contract and, as such, is not a Force Majeure event.

8.3.3 Should either party be rendered unable, either wholly or in part, by an event of Force Majeure to fulfill its obligations under the Contract, the obligation(s) affected by such event of Force Majeure shall be suspended only during the continuance of the Force Majeure event. Suspension of Work is not required for a Force Majeure event. The party so affected shall give notice of the existence, extent and nature of such Force Majeure in writing to the other party within forty-eight (48) hours after the commencement of the Force Majeure event. The party so affected shall remedy such inability with all reasonable dispatch and shall use due diligence in this regard. Failure to give such notice shall result in the continuance of such party's obligation regardless of the extent of any existing Force Majeure event. Pursuant to California Civil Code section 1511, the Parties agree that any failure to submit a timely and properly documented notice and description of a Force Majeure event shall constitute a waiver by Design-Builder of any claim for additional compensation, time or impact costs from Owner.

8.3.4 Nothing within this Article shall restrict the Owner's rights to pursue a termination or suspension pursuant to the Contract Documents.

8.5 Liquidated Damages

8.5.1 Liquidated Damages are the specified dollar amount the Design-Builder shall pay to the Owner due to the Design-Builder's failure to complete the Work within the Work Completion Time or within Contract Milestones. Unless provided otherwise in the Contract Documents. Liquidated Damages are intended to cover Owner's administrative, inspection, project management, and professional services costs in the period of extended construction and shall not be construed to cover or apply to costs of completion of the Work, costs or delays resulting from defective work, property damage or any costs or damages covered by insurance of any type.

8.5.2 The parties recognize and agree that time is of the essence for this Contract. If Substantial Completion has not occurred on or before the scheduled Substantial Completion date, or Work is not completed within the shutdown constraints as described in the DBIA Document No. 545, Owner will assess Liquidated Damages, as it is and will be impractical and extremely difficult to ascertain the actual damages which Owner will sustain in the event of and by reason of such delay. Liquidated Damages will be assessed for each missed shutdown constraint or failure to timely achieve Substantial Completion and thus may be cumulative. Owner shall have the right to deduct said Liquidated Damages from any amount due or that may become due the Design-Builder, or to collect such Liquidated Damages from the Design-Builder or its surety. These Liquidated Damages shall not be construed as a penalty.

8.5.3 Execution of the Contract shall constitute agreement by Owner and Design-Builder that the amount specified in the Contract Documents is the minimum value of the costs and actual damage caused by the failure of the Design-Builder to complete the Work within the allotted time. Such sum is Liquidated Damages and may be deducted from payments due the Design-Builder if such delay occurs.

8.5.4 Owner expressly denies that any progress payments made after the scheduled completion date constitute a waiver of Liquidated Damages.

8.5.5 These provisions shall not prevent Owner, in the case of the Design-Builder's default under this Contract, from terminating the right of the Design-Builder to proceed as provided in the Contract Documents and seeking all damages and other remedies available to Owner under this Contract or by Law.

Article 9

Changes to the Contract Price and Time

9.1 Change Orders

9.1.1 A Change Order is a written instrument issued after execution of the Agreement signed by Owner and Design-Builder, stating their agreement upon all of the following:

9.1.1.1 The scope of the change in the Work;

9.1.1.2 The amount of the adjustment to the Contract Price; and

9.1.1.3 The extent of the adjustment to the Contract Time(s).

9.1.2 All changes in the Work authorized by applicable Change Order shall be performed under the applicable conditions of the Contract Documents. Owner and Design-Builder shall negotiate in good faith and as expeditiously as possible the appropriate adjustments for such changes.

9.1.3 The Contract Pricing and Work Completion Time may only be changed by executed Change Order. Change Orders are generally bilateral signed by the Design-Builder and by Owner. Owner may also issue unilateral Change Orders, should there be an impasse on executing a bilateral agreement or time does not permit further negotiations.

9.1.4 No extra work or change in the Contract Documents shall be made unless by a written Change Order approved by Owner. No claim for any change to the Contract Pricing or Work Completion Time shall be valid unless so ordered. A Change Order signed by the Design-Builder conclusively establishes the Design-Builder's agreement therewith, including the adjustment in the Contract Pricing and the Work Completion Time. Owner reserves the right to contract with any person or firm other than the Design-Builder for any or all changed work.

9.1.5 Accord and Satisfaction. It is the intent of Owner to settle each Change Order full and final at the time the Change Order is issued. Therefore, the following language will be deemed incorporated into all Change Orders:

"The undersigned hereby proposes and agrees to furnish any and all labor, material and equipment, including all overhead and profit, in strict accordance with the requirements of the original Contract Documents except as specifically above noted otherwise for the sum stated above, and that are required in connection with the above proposed change.

By signing the Change Order, the Design-Builder acknowledges and agrees, on behalf of himself, all subcontractors, and all suppliers, that the stipulated compensation includes payment for all work contained in the Change Order, plus all payment for the interruption of schedules, extended overhead costs, delay, all impacts, and ripple effect of cumulative impact on all other work under this Contract. The signing of the Change Order indicates that the Change Order constitutes the compensation (time and cost) set forth in the Change Order and comprises the total compensation due the Design-Builder, all subcontractors, and all suppliers, for the Work or change defined in the Change Order, including impact on unchanged work. The Design-Builder is in full mutual accord and satisfaction with the change, and that the time and /or cost under the Change Order constitute the total equitable adjustment owed the Design-Builder, all subcontractors, and all suppliers, as a

result of the changes. The Design-Builder, on behalf of the Design-Builder, all subcontractors, and all suppliers, agrees to waive all right, without exception or reservation of any kind whatsoever, to file any further Claim related to this Change Order No further Claim or request for equitable adjustment of any type shall arise out of or as a result of this Change Order or the impact of this Change Order on the remainder of the Work under the Contract. The Design-Builder further agrees to indemnify and hold the Owner and its agents harmless from any further Claims, requests for equitable adjustment, or damages raised by subcontractors or suppliers at any tier, as a result of the Work under this Contract. The Design-Builder, on behalf of the Design-Builder, all subcontractors, and all suppliers, expressly waives the benefits of the provisions of Section 1542 of the Civil Code, which reads as follows: "A GENERAL RELEASE DOES NOT EXTEND TO CLAIMS WHICH THE CREDITOR DOES NOT KNOW OR SUSPECT TO EXIST IN HIS OR HER FAVOR AT THE TIME OF EXECUTING THE RELEASE, WHICH IF KNOWN BY HIM OR HER MUST HAVE MATERIALLY AFFECTED HIS OR HER SETTLEMENT WITH THE DEBTOR." The Owner and the Design-Builder hereby agree that this Change Order constitutes full mutual accord and satisfaction for all time, all costs, and all impacts related directly to this Change Order."

9.1.6 Unilateral Change Order. In case of failure on the part of Owner and the Design-Builder to arrive at an agreement on the amount of a credit or an extra cost for a proposed change to the Contract Documents, a unilateral Change Order will be processed in the amount believed by Owner to be reasonable and the Design-Builder shall proceed with the Work. If the Design-Builder believes that the amount set forth in the unilateral Change Order is not a reasonable payment for the Work required the Design-Builder may file a Claim and request for review in accordance with Article 10.

9.1.7 No oral statement of any person including the Design-Builder's personnel shall in any manner or degree, modify or otherwise affect the terms of this Contract.

9.1.8 Contractor's Overhead and Profit Limitation - For all negotiated Change Orders the allowance for overhead and profit shall include full compensation for extended overhead, home office overhead, and all other items of expense or cost not included in the cost of labor (rates to be negotiated), materials (based on invoice), or equipment provided (based on blue book) for in this Article. The allowance for overhead and profit shall not exceed the following schedule:

	Overhead	Profit
Labor =	10 percent	15 percent
Materials =	10 percent	5 percent
Equipment =	10 percent	10 percent

9.1.9 Subcontractor Mark Up - It is understood that labor, materials, and equipment may be furnished by the Design-Builder or by a Subcontractor on behalf of the Design-Builder. When all or any part of the extra work is performed by a Subcontractor, the allowance specified herein shall be applied to the labor, materials, and equipment costs of the Subcontractor, to which the Design-Builder may add 5 percent of the Subcontractor's total cost for the extra work. Regardless of the number of hierarchical tiers of Subcontractors, the 5 percent increase above the performing subcontractor's total cost which includes the allowances for overhead and profit may be applied one time only.

9.1.10 Equipment Rental Rates – Rental equipment required specifically for the Additional Work. Whenever possible, changed work will be accomplished using equipment available on-site or owned by the Design-Builder. If no on-site equipment can be used and a specific piece of equipment must be rented to be used exclusively for the changed work, the rental rate that will apply will be the rate shown on the supplier's invoice. In the event that equipment used is owned by the Design-Builder, the Design-Builder may use the current rental rates per the State of California Department of Transportation Labor Surcharge and Equipment Rental Rates.

9.1.11 Design-Builder's Extra Work Report - In order to be paid for extra work based on time and materials, the Design-Builder must submit a daily Extra Work Report on a form provided by the

Owner's Representative. The form must be completely filled out based on the provisions of this Article and signed by the Design-Builder and Owner's Representative at the end of each work day. Failure to complete the form and obtain appropriate signatures by the next working day after the Work was completed will result in Design-Builder's costs for extra work being disallowed until such form is completed and agreed to by the Owner's Representative. Delay in submitting the form beyond seven (7) days will result in the Owner's records becoming the official record for payment purposes.

9.1.12 Except as otherwise provided in this Article, Change Orders shall not include"

- a. Overhead Costs - Payroll costs and other compensation of Design-Builder's officers, executives, principals, general manager, engineers, architects, estimators, attorneys, auditors, accountants, purchasing and contracting agents, timekeepers, clerks and other personnel employed by Design-Builder whether at the site or in Design-Builder's principal office, a branch office or material yard and ship for general administration of the Work or not specifically covered by this Article all of which are to be considered administrative costs covered by the Design-Builder's allowance for overhead and profit.
- b. Office Expense - Expenses of Design-Builder's principal and branch offices.
- c. Capital Expenses - Any part of Design-Builder's capital expenses, including interest on Design-Builder's capital employed for the Work and charges against Design-Builder for delinquent payments.
- d. Premiums - Cost of premiums for all Bonds and for all insurance whether or not Design-Builder is required by the Contract Documents to purchase and maintain the same.
- e. Negligence - Costs due to the negligence of Design-Builder, any Subcontractor, or anyone directly or indirectly employed by any of them or for whose acts any of them may be liable, including but not limited to the correction of defective work, disposal of materials or equipment wrongly supplied, and making good any damage to property.
- f. Other - Other overhead or general expense costs of any kind and the cost of any item not specifically and expressly included in this Article.
- g. Small Tools - Cost of small tools valued at less than \$500 and that remain the property of the Design-Builder.
- h. Administrative Costs - Costs associated with the preparation of Change Orders (whether or not ultimately authorized), cost estimates, or the preparation or filing of claims.
- i. Anticipated Lost Profits - Expenses of the Design-Builder associated with anticipated lost profits or lost revenues, lost income or earnings, lost interest on earnings or unpaid retainage
- j. Home Office Overhead - Costs derived from the computation of a "home office overhead" rate by application of the Eichleay, Allegheny, Burden Fluctuation, or other similar methods.
- k. Special Consultants and Attorneys - Costs of special consultants or attorneys, whether or not in the direct employ of the Design-Builder, employed for services specifically related to the resolution of a claim, dispute, or other matter relating to the acceptability of the Work.

9.1.12 No Additional Compensation for Overtime - Except as otherwise provided in this Article, the **Design-Builder** shall receive no additional compensation for overtime Work (i.e., work in excess of 8 hours in any one calendar day or 40 hours in any one calendar week), even though such overtime Work may be required under emergency conditions and may be ordered by the Owner in writing. Owner will pay additional compensation to the **Design-Builder** for overtime Work

only in the event extra Work is ordered by the Owner, and the Change Order specifically authorizes the use of overtime Work and then only to such extent as overtime wages are regularly being paid by the **Design-Builder** for overtime Work of a similar nature in the same locality.

9.2 Work Change Directives.

9.2.1 Owner and Design-Builder shall negotiate in good faith and as expeditiously as possible the appropriate adjustments for the Work Change Directive. Upon reaching an agreement, the parties shall prepare and execute an appropriate Change Order reflecting the terms of the agreement.

9.3 Minor Changes in the Work.

9.3.1 Minor changes in the Work do not involve an adjustment in the Contract Price and/or Contract Time(s) and do not materially and adversely affect the Work, including the design, quality, performance and workmanship required by the Contract Documents. Design-Builder may request in writing minor changes in the Work consistent with the intent of the Contract Documents and may proceed with such changes upon receiving written concurrence from the Owner.

9.4 Contract Price Adjustments.

9.4.1 The increase or decrease in Contract Price resulting from a change in the Work shall be determined by one or more of the following methods:

9.4.1.1 Unit prices set forth in the Agreement or as subsequently agreed to between the parties;

9.4.1.2 A mutually accepted lump sum, properly itemized and supported by sufficient substantiating data to permit evaluation by Owner;

9.4.1.3 Costs, fees and any other markups set forth in the Agreement; or

9.4.1.4 If an increase or decrease cannot be agreed to as set forth in items 9.4.1.1 through 9.4.1.3 above and Owner may issue a Work Change Directive, the cost of the change of the Work shall be determined by the reasonable expense and savings in the performance of the Work resulting from the change, including a reasonable overhead and profit, as may be set forth in the Agreement.

9.4.2 If unit prices are set forth in the Contract Documents or are subsequently agreed to by the parties, but application of such unit prices will cause substantial inequity to Owner or Design-Builder because of differences in the character or quantity of such unit items as originally contemplated, such unit prices shall be equitably adjusted.

9.5 Escalation of Cost

9.5.1 Potential Time and Price-Impacted Material. Not applicable

9.5.2 Baseline Price and Time. Not applicable

9.5.2.1 Not applicable

9.5.3 Adjustment In Baseline Price. Not applicable

9.5.4 Time Impact and Availability. Not applicable

9.6 Emergencies

9.5.1 In any emergency affecting the safety of persons and/or property, Design-Builder shall act, at its discretion, to prevent threatened damage, injury or loss. Any change in the Contract Price and/or Contract Time(s) on account of emergency work shall be determined as provided in this Article 9.

Article 10

Contract Adjustments and Disputes

10.1 Requests for Contract Adjustments and Relief

10.1.1 Claims. For purposes of this Article, "Claim" means a separate demand by the Design-Builder for one of more of the following: (A) a time extension, (B) payment of money or damages arising from Work done by or on behalf of the Design-Builder pursuant to the Contract, or (C) an amount the payment of which is disputed by the Owner. In accordance with California Public Contract Code Section 20104.2 and Public Contract Code Section 9204, presuming Design-Builder has diligently pursued and exhausted the administrative procedures of the Contract, the procedures in this Article apply to claims between the Design-Builder and the Owner.

10.1.2 If the Design-Builder believes that it is entitled to relief against the Owner for any event arising out of or related to the Work or Project, Design-Builder shall provide written notice to the Owner of the basis for its claim for relief, as provided for in Articles 8 and 9. In the event that the Design-Builder does not accept the Owner's decision on a Change Order Request, the Design-Builder must within 30 calendar days of a written rejection submit in writing and in electronic form to the Owner with all documentation which it believes relate to the issues it is raising ("Dispute Submittal"). All disputes and negotiations shall be documented by each Party in writing in accordance with the Agreement and shall state each claim specifically, show the calculation and basis for each claim for compensation and the schedule (including fragnet) analysis for each schedule demand. Any claim that lacks specific calculation or documentary support will not be considered. Pursuant to California Civil Code section 1511, the Parties agree that any failure to submit a timely Contractor Change Request or Dispute Submittal shall constitute a waiver by Design-Builder of any claim for additional compensation, time or impact costs from Owner.

10.1.3 Certification of Dispute Submittal. Any claim, including without limitation any claim filed on behalf of or having its source in a claim by subcontractor, sub-subcontractor, or supplier, at any tier, which the Design-Builder chooses to make to Owner, shall be accompanied by the certification language set forth below signed by a responsible managing officer of the Design-Builder's organization, who has the authority to sign subcontracts or Purchase Orders on behalf of the Design-Builder, and who has personally investigated and confirmed the truth and accuracy of the matters set forth in such certification. Submission of certification in accordance herewith is a condition precedent to Owner's consideration of or decision on the claim and to the filing and maintenance of any legal action or proceeding to enforce or recover monies under such claim. Failure to submit such a certification along with the claim shall result in the claim being returned to the Design-Builder without any decision, and shall waive the Design-Builder's right to pursue the claim either on its own behalf or on behalf of such subcontractor or supplier.

10.1.4 The certification shall state: "I hereby certify under penalty of perjury that I am a managing officer of (Design-Builder's name) and that I have reviewed the Claim presented herewith on Design-Builder's behalf and/or on behalf of (subcontractor's/supplier's name(s)) and that the following statements are true and correct:

The facts alleged in or that form the basis for the Claim are true and accurate; and, Design-

Builder does not know of any facts or circumstances, not alleged in the Claim, that by reason of their not being alleged render any fact or statement alleged in the Claim materially misleading; and,

Design-Builder has, with respect to any request for money or damages alleged in or that forms the basis for the Claim, reviewed the job cost records (including those maintained by Design-Builder and by any subcontractor or supplier, of any tier, that is asserting all or any portion of the Claim) and confirmed with mathematical certainty that the losses or damages suffered by Design-Builder and /or such subcontractor or supplier were in fact suffered in the amounts and for the reasons alleged in the Claim; and,

Design-Builder has, with respect to any request for extension of time or claim of delay, disruption, hindrance or interference alleged in or that forms the basis for the Claim, reviewed the job schedules (including those maintained by Design-Builder and by any subcontractor or supplier, of any tier, that is asserting all or any portion of the Claim) and confirmed on an event-by-event basis that the delays or disruption suffered by Design-Builder and /or such subcontractor or supplier were in fact experienced for the durations, in the manner, and with the consequent effects on the time and/or sequence of performance of the Work, as alleged in the Claim; and,

Design-Builder has not received payment from Owner for, nor has Design-Builder previously released Owner from any portion of the Claim."

Design-Builder Signature Line _____

10.1.5 Owner's Response. Upon receipt of a claim pursuant to this Article, the Owner shall conduct a reasonable review of the claim and provide a written response to the Design-Builder within 45 days of the date of the claim, identifying the portion of the claim that is disputed and the portion that is undisputed. Upon receipt of a claim, the Owner and the Design-Builder may, by mutual agreement, extend the time period provided in this subdivision.

10.1.5.1 All amounts that the Owner identifies in its response as undisputed must be processed and paid within 60 days of the Owner's response. Pursuant to Public Contract Code section 9204(d)(4), if the Owner fails to pay within 60 days, undisputed amounts not paid will bear interest at 7 percent per annum.

10.1.5.2 If the Owner needs approval from its governing body to provide the Design-Builder a written statement identifying the disputed portion and the undisputed portion of the claim, and the Owner's governing body does not meet within the 45 days or within the mutually agreed to extension of time following receipt of a claim sent by registered mail or certified mail, return receipt requested, the Owner shall have up to (3) three days following the next duly publicly noticed meeting of the Owner's governing body after the 45-day period, or extension, expires to provide the Design-Builder a written statement identifying the disputed portion and the undisputed portion.

10.1.6 Meet and Confer. If the Design-Builder disputes the Owner's written response, or the Owner fails to respond within the time prescribed, the Design-Builder may so notify the Owner, in writing, either within 15 days of receipt of the Owner's response or within 15 days of the Owner's failure to respond within the time prescribed, respectively, and demand an informal conference to meet and confer for settlement of the issues in dispute. Upon receipt of a demand, the Owner shall schedule a meet and confer conference within 30 days for settlement of the dispute.

10.1.7 Mediation. Within 10 business days following the conclusion of the meet and confer conference, if the claim or any portion of the claim remains in dispute, the Owner shall provide the Design-Builder a written statement identifying the portion of the claim that remains in dispute and the portion that is undisputed. Any payment due on an undisputed portion of the claim shall be

processed and made within 60 days after the Owner issues its written statement. If the Owner fails to pay within 60 days, undisputed amounts not paid will bear interest at 7 percent per annum. Any disputed portion of the claim, as identified by the Design-Builder in writing, shall be submitted to nonbinding mediation, with the Owner and the Design-Builder sharing the associated costs equally. The Owner and Design-Builder shall mutually agree to a mediator within 10 business days after the disputed portion of the claim has been identified in writing, unless the parties agree to select a mediator at a later time.

10.1.7.1 If the parties cannot agree upon a mediator, each party shall select a mediator and those mediators shall select a qualified neutral third party to mediate with regard to the disputed portion of the claim. Each party shall bear the fees and costs charged by its respective mediator in connection with the selection of the neutral mediator.

10.1.7.2 For purposes of this section, mediation includes any nonbinding process, including, but not limited to, neutral evaluation or a dispute review board, in which an independent third party or board assists the parties in dispute resolution through negotiation or by issuance of an evaluation. Any mediation utilized shall conform to the timeframes in this section.

10.1.7.3 Unless otherwise agreed to by the Owner and the Design-Builder in writing, the mediation conducted pursuant to this section shall excuse any further obligation under Public Contract Code Section 20104.4 to mediate after litigation has been commenced.

10.1.7.4 This section does not preclude the Owner from requiring arbitration of disputes under private arbitration or the Public Works Contract Arbitration Program, if mediation under this section does not resolve the parties' dispute.

10.1.7.5 The mediation shall be held no earlier than the date the Design-Builder completes the Work or the date that the Design-Builder last performs Work, whichever is earlier. All unresolved claims shall be considered jointly in a single mediation, unless a new unrelated claim arises after mediation is complete.

10.2 Legal Proceedings

10.2.1 Civil Actions. Procedures for civil actions to resolve claims of \$375,000 or less between the District and the Design-Builder are governed pursuant to Public Contract Code Section 20104.4.

10.2.2 Government Code Claims. In addition to any and all contract requirements pertaining to notices of and requests for compensation or payment for extra Work, disputed Work, construction claims and/or changed conditions, the Design-Builder must comply with the claim procedures set forth in Government Code Sections 900, et seq. prior to filing any lawsuit against the Owner. Such Government Code claims and any subsequent lawsuit based upon the Government Code claims shall be limited to those matters that remain unresolved after all procedures pertaining to the extra Work, disputed Work, construction claims, and/or changed conditions have been followed by the Design-Builder. If no such Government Code claim is submitted, or if the prerequisite contractual requirements are not satisfied, no action against the Owner may be filed. A Government Code claim must be filed no earlier than the date the Work is completed or the date the Design-Builder last performs Work on the Project, whichever occurs first. A Government Code claim shall be inclusive of all unresolved claims unless a new unrelated claim arises after the Government Code claim is submitted.

10.2.3 Non-Waiver. The Owner's failure to respond to a claim from the Design-Builder within the time periods described in this Article or to otherwise meet the time requirements of this Article shall result in the claim being deemed rejected in its entirety. A claim that is denied by reason of the Owner's failure to have responded to a claim, or its failure to otherwise meet the time requirements

of this section, shall not constitute an adverse finding with regard to the merits of the claim or the responsibility or qualifications of the Design-Builder.

10.2.4 Forum for Dispute Resolution. It is the express intention of the parties that all legal proceedings related to this Agreement or to the Project or to any rights or any relationship between the parties arising therefrom shall be solely and exclusively initiated and maintained in San Bernardino County Superior Court. The Design-Builder and Owner each irrevocably consents to the jurisdiction of such courts in any such legal proceeding and waives any objection it may have to the laying of the jurisdiction of any such legal proceeding.

10.2.5 The prevailing party in any legal action or proceeding, or any other final, binding dispute proceeding upon which the parties may agree, shall be entitled to recover from the other party actual attorneys' fees and expenses incurred by the prevailing party.

10.3 Duty to Continue Performance

10.3.1 Unless provided to the contrary in the Contract Documents, Design-Builder shall continue to perform the Work and Owner shall continue to satisfy its payment obligations to Design-Builder, pending the final resolution of any dispute or disagreement between Design-Builder and Owner.

Article 11

Suspension and Termination for Cause

11.1 Owner's Right to Suspend Work

11.1.1 Owner may suspend all or any part of the Work by written order signed by Owner ("Suspension Order"), without invalidating the Agreement, for such period or periods as it may deem necessary due to:

11.1.1.1 Any reason for the convenience of the Owner, with or without cause;

11.1.1.2 An order from a state or federal court or a government administrative agency; or

11.1.1.3 The Design-Builder's failure to perform any provision of the Contract Documents.

11.1.2 Upon receipt from Owner of a Suspension Order, the Design-Builder shall, unless the notice requires otherwise:

11.1.2.1 Immediately discontinue work on the date and to the extent specified in the notice;

11.1.2.2 Place no further orders or subcontracts for material, services, or facilities with respect to suspended work other than to the extent required in the notice;,

11.1.2.3 Promptly make every reasonable effort to obtain suspension in terms satisfactory to Owner of all orders, subcontracts and rental agreements to the extent they relate to performance of suspended work;

11.1.2.4 Continue to protect and maintain the Work including those portions on which work has been suspended; if the Design-Builder fails to properly provide for public safety, traffic, and protection of the Work during periods of suspension, Owner may elect to do so and back charge or deduct the cost thereof from monies due the Design-Builder. Such actions will not relieve the Design-Builder from liability.

11.1.2.5 Within three (3) days of the receipt of the Suspension Order, submit a suspension plan to Owner for acceptance. The plan shall describe how the Design-Builder will store all materials in a manner so that the materials will not become an obstruction or become damaged in any way, what cost effective methods it will employ to prevent damage to or deterioration of the Work and otherwise protect the Work, how suitable drainage will be provided, what temporary structures will be necessary, and how the Design-Builder will prepare for resuming the Work for the least possible remobilization cost. After the plan is accepted, the Design-Builder shall implement it in accordance with instructions received from Owner; and

11.1.2.6 Take any and all measures to minimize costs associated with such suspension.

11.1.3 Under no circumstance shall a suspension absolve the Design-Builder or the Design-Builder's sureties of the duties and responsibilities guaranteed under the performance and payment bond(s). The Design-Builder shall again proceed with the Work when it is ordered to do so in writing by Owner.

11.1.4 Design-Builder is entitled to seek an adjustment of the Contract Price and/or Contract Time(s) if its cost or time to perform the Work has been adversely impacted by any suspension of stoppage of the Work by Owner. If the Design-Builder intends to assert a claim for compensation or time extension under this Article, it must, and notwithstanding any time limitations specified elsewhere in the Contract Documents, within seven (7) calendar days after receipt of notice to resume work, submit to Owner a Contractor Change Request setting forth the schedule impact and monetary impact of the suspension in sufficient detail to permit thorough analysis. Adjustment of work Completion Time, if appropriate, will be made pursuant to the provisions of the Contract Documents. Adjustment of the not to exceed contract amount, if any, will be within the Owner's sole discretion and shall not in any event, exceed the cost of the extra work resulting from such suspension. Such cost, if any, shall be determined in accordance with the Contract Documents. Pursuant to California Civil Code section 1511, the Parties agree that any failure to submit a timely and properly documented Contractor Change Request shall constitute a waiver by Design-Builder of any claim for additional compensation, time or impact costs from Owner.

11.1.5 Suspension due to a ruling of City, State or Federal Court -- The Suspension Order will identify the court or agency ruling which caused the suspension, and subject to Owner approval, may extend the Work Completion Time by the stated amount of time specified by the court or agency order. If the ruling causes suspension for an indefinite period of time and as a result a time extension cannot be established, the Suspension Order may also be for an indefinite period of time, subject to Owner approval. If the Suspension Order is issued because of acts or omissions of the Design-Builder, the Design-Builder shall not be entitled to a time extension or payment for any additional costs it incurs.

11.1.6 Suspension Resulting from Design-Builder's Failure to Perform -- If a Suspension Order results from the Design-Builder's failure to satisfactorily perform any of the provisions of the Agreement, including but not limited to faulty workmanship, safety concerns, improper or inadequate manpower, equipment, supplies or supervision, or failure to perform the Work or pay employees, subcontractors or suppliers in a timely manner, the Suspension Order will identify the reason, or reasons, for the order. In this circumstance, no time extension will be authorized for the Design-Builder and any costs to the Design-Builder resulting from such Suspension Order will not be reimbursed by Owner. A Suspension Order issued under these circumstances will remain in effect until the Design-Builder has removed or corrected the grounds for the suspension, or the Suspension Order expires by its terms.

11.2 Owner's Right to Perform and Terminate for Cause

11.2.1 If Design-Builder persistently fails to (i) provide a sufficient number of skilled workers, (ii) supply the materials required by the Contract Documents, (iii) comply with applicable Legal Requirements, (iv) timely pay, without cause, Design Consultants or Subcontractors, (v) prosecute

the Work with promptness and diligence to ensure that the Work is completed by the Contract Time(s), as such times may be adjusted, or (vi) perform material obligations under the Contract Documents, then Owner, in addition to any other rights and remedies provided in the Contract Documents or by law, shall have the rights set forth in Sections 11.2.2 and 11.2.3 below.

11.2.2 Upon the occurrence of an event set forth in Section 11.2.1 above, Owner may provide written notice to Design-Builder that it intends to terminate the Design-Builder's performance unless the problem cited is cured, or commenced to be cured, within seven (7) days of Design-Builder's receipt of such notice. If Design-Builder fails to cure, or reasonably commence to cure, such problem, then Owner may give a second written notice to Design-Builder of its intent to terminate within an additional seven (7) day period. If Design-Builder, within such second seven (7) day period, fails to cure, or reasonably commence to cure, such problem, then Owner may declare the Agreement terminated for default by providing written notice to Design-Builder of such declaration.

11.2.3 Upon declaring the Agreement terminated pursuant to Section 11.2.2 above, Owner may elect to:

11.2.3.1 Enter upon the premises and take possession, for the purpose of completing the Work, of all materials, equipment, scaffolds, tools, appliances and other items thereon, which have been purchased or provided for the performance of the Work, all of which Design-Builder hereby transfers, assigns and sets over to Owner for such purpose, and to employ any person or persons to complete the Work and provide all of the required labor, services, materials, equipment and other items. In the event of such termination, Design-Builder shall not be entitled to receive any further payments under the Contract Documents until the Work shall be finally completed in accordance with the Contract Documents. At such time, if the unpaid balance of the Contract Price exceeds the cost and expense incurred by Owner in completing the Work, such excess shall be paid by Owner to Design-Builder. Notwithstanding the preceding sentence, if the Agreement establishes a Guaranteed Maximum Price, Design-Builder will only be entitled to be paid for Work performed prior to its default. If Owner's cost and expense of completing the Work exceeds the unpaid balance of the Contract Price, then Design-Builder shall be obligated to pay the difference to Owner. Such costs and expense shall include not only the cost of completing the Work, but also losses, damages, costs and expense, including attorneys' fees and expenses, incurred by Owner in connection with the re-procurement and defense of claims arising from Design-Builder's default, subject to the waiver of consequential damages set forth in Article 13 in the 545 Design Build Agreement hereof; or

11.2.3.2 Serve written notice upon the Design-Builder and its surety on its performance bond demanding satisfactory compliance with the Contract.

- i. If the surety assumes the Contract, all money which may become due the Design-Builder shall be payable to the surety as the Work progresses, subject to the terms of the Contract.
- ii. If the surety does not assume the Contract and commence performance of the Work within twenty-one (21) days after receiving the Executive Director's notice and demand, or fails to continue to comply, the Executive Director may remove the surety from the premises. If the surety bond has provisions contrary to this right, then the 60 day time limit stated elsewhere in this Contract shall apply.
- iii. Upon any Surety default, Owner may then take possession of all material and equipment and complete the Work by use of its own forces, by letting the unfinished work to another Design-Builder, or by a combination of such methods. In any event, the cost of completing the Work shall be charged against the Design-Builder and its surety and may be deducted from any money due or becoming due from the Design-Builder. If the amount unpaid

under the Agreement is insufficient for completion, the Design-Builder or surety shall pay to Owner within five (5) days after the completion and an itemized demand for payment from Owner, all costs and damages incurred by Owner in excess of the amount unpaid under the Agreement.

11.2.4 If Owner improperly terminates the Agreement for cause, the termination for cause will be converted to a termination for convenience in accordance with the provisions of Article 8 of the Agreement.

11.5 Bankruptcy of Owner or Design-Builder

11.5.1 If either Owner or Design-Builder institutes or has instituted against it a case under the United States Bankruptcy Code (such party being referred to as the "Bankrupt Party"), such event may impair or frustrate the Bankrupt Party's ability to perform its obligations under the Contract Documents. Accordingly, should such event occur:

11.5.1.1 The Bankrupt Party, its trustee or other successor, shall furnish, upon request of the non-Bankrupt Party, adequate assurance of the ability of the Bankrupt Party to perform all future material obligations under the Contract Documents, which assurances shall be provided within ten (10) days after receiving notice of the request; and

11.5.1.2 The Bankrupt Party shall file an appropriate action within the bankruptcy court to seek assumption or rejection of the Agreement within sixty (60) days of the institution of the bankruptcy filing and shall diligently prosecute such action.

If the Bankrupt Party fails to comply with its foregoing obligations, the non-Bankrupt Party shall be entitled to request the bankruptcy court to reject the Agreement, declare the Agreement terminated and pursue any other recourse available to the non-Bankrupt Party under this Article 11.

11.5.2 The rights and remedies under Section 11.5.1 above shall not be deemed to limit the ability of the non-Bankrupt Party to seek any other rights and remedies provided by the Contract Documents or by law, including its ability to seek relief from any automatic stays under the United States Bankruptcy Code or the right of Design-Builder to stop Work under any applicable provision of these General Conditions of Agreement.

Article 12

Electronic Data

12.1 Electronic Data

12.1.1 The parties recognize that Contract Documents, including drawings, specifications and three-dimensional modeling (such as Building Information Models) and other Work Product may be transmitted among Owner, Design-Builder and others in electronic media as an alternative to paper hard copies (collectively "Electronic Data").

12.2 Transmission of Electronic Data

12.2.1 Owner and Design-Builder shall agree upon the software and the format for the transmission of Electronic Data. Each party shall be responsible for securing the legal rights to access the agreed-upon format, including, if necessary, obtaining appropriately licensed copies of the applicable software or electronic program to display, interpret and/or generate the Electronic Data.

12.2.2 Neither party makes any representations or warranties to the other with respect to the functionality of the software or computer program associated with the electronic transmission of Work Product. Unless specifically set forth in the Agreement, ownership of the Electronic Data does not include ownership of the software or computer program with which it is associated, transmitted, generated or interpreted.

12.2.3 By transmitting Work Product in electronic form, the transmitting party does not transfer or assign its rights in the Work Product. The rights in the Electronic Data shall be as set forth in Article 5 of the Agreement. Under no circumstances shall the transfer of ownership of Electronic Data be deemed to be a sale by the transmitting party of tangible goods.

12.3 Electronic Data Protocol

12.3.1 The parties acknowledge that Electronic Data may be altered or corrupted, intentionally or otherwise, due to occurrences beyond their reasonable control or knowledge, including but not limited to compatibility issues with user software, manipulation by the recipient, errors in transcription or transmission, machine error, environmental factors, and operator error. Consequently, the parties understand that there is some level of increased risk in the use of Electronic Data for the communication of design and construction information and, in consideration of this, agree, and shall require their independent contractors, Subcontractors and Design Consultants to agree, to the following protocols, terms and conditions set forth in this Section 12.3.

12.3.2 Electronic Data will be transmitted in the format agreed upon in Section 12.2.1 above, including file conventions and document properties, unless prior arrangements are made in advance in writing.

12.3.3 The Electronic Data represents the information at a particular point in time and is subject to change. Therefore, the parties shall agree upon protocols for notification by the author to the recipient of any changes which may thereafter be made to the Electronic Data, which protocol shall also address the duty, if any, to update such information, data or other information contained in the electronic media if such information changes prior to Final Completion of the Project.

12.3.4 The transmitting party specifically disclaims all warranties, expressed or implied, including, but not limited to, implied warranties of merchantability and fitness for a particular purpose, with respect to the media transmitting the Electronic Data. In the event of conflicts or inconsistencies in the Electronic Data and the corresponding signed hard copy of the Work Product, the hard copy of the Work Product shall prevail. Other than to extent limited by the foregoing, transmission of the Electronic Data via electronic means shall not invalidate or negate any duties pursuant to the applicable standard of care with respect to the creation of the Electronic Data, unless such data is materially changed or altered after it is transmitted to the receiving party, and the transmitting party did not participate in such change or alteration.

Article 13

Miscellaneous

13.1 Confidential Information

13.1.1 Confidential Information is defined as information which is determined by the transmitting party to be of a confidential or proprietary nature and: (i) the transmitting party identifies as either confidential or proprietary; (ii) the transmitting party takes steps to maintain the confidential or proprietary nature of the information; and (iii) the document is not otherwise available in or considered to be in the public domain. The receiving party agrees to maintain the confidentiality of

the Confidential Information and agrees to use the Confidential Information solely in connection with the Project.

13.1.2 The parties understand that all the material provided or produced under this Agreement may be subject to the California Public Records Act, Cal. Government Code section 6250, et seq., and that in the event of a request to the Owner for disclosure of such information, the Owner shall advise the Design-Builder of such request in order to give the Design-Builder the opportunity to object to the disclosure of any of its proprietary or confidential material. In the event of the filing of a lawsuit to compel such disclosure, the Owner will tender all such material to the court for judicial determination of the issue of disclosure and the Design-Builder agrees to intervene in such lawsuit to protect and assert its claims of privilege against disclosure of such material. The Design-Builder further agrees to defend, indemnify and save and hold harmless the Owner, its council, officers, agents and employees, from any claim, damages, expense, loss or costs arising out of the Design-Builder's intervention to protect and assert its claims of privilege against disclosure under this Article including, but not limited to, prompt reimbursement to the Owner of all reasonable attorney fees, costs and damages that the Owner may incur directly or may be ordered to pay by such court.

13.2 Assignment

13.2.1 Neither Design-Builder nor Owner shall, without the written consent of the other assign, transfer or sublet any portion or part of the Work or the obligations required by the Contract Documents.

13.2.2 For purposes of this Contract, the terms "transfer" and "assign" shall include, but not be limited to, the following:

13.2.2.1 If the Design-Builder is a joint venture, a limited liability company, or a partnership, the transfer of fifty percent (50%) or more of the interest or membership in the joint venture, the limited liability company, or the partnership;

13.2.2.2 If the Design-Builder is a corporation, any cumulative or aggregate sale, transfer, merger, assignment, or hypothecation of fifty percent (50%) or more of the voting shares of the Design/Builder;

13.2.2.3 The dissolution by any means of Design-Builder; and

13.2.2.4 A change in business or corporate structure. Any such transfer, assignment, mortgaging, pledging, or encumbering of Design/Builder without the written consent of the Owner is a violation of this Contract and shall be voidable at Owner's option and shall confer no right, title, or interest in or to this Contract upon the assignee, mortgagee, pledgee, encumbrance, or other lien holder, successor, or purchaser.

13.3 Successorship

13.3.1 Design-Builder and Owner intend that the provisions of the Contract Documents are binding upon the parties, their employees, agents, heirs, successors and assigns.

13.4 Governing Law

13.4.1 The Agreement and all Contract Documents shall be governed by the laws of the place of the Project, without giving effect to its conflict of law principles.

13.5 Severability

13.5.1 If any provision or any part of a provision of the Contract Documents shall be finally determined to be superseded, invalid, illegal, or otherwise unenforceable pursuant to any applicable Legal Requirements, such determination shall not impair or otherwise affect the validity,

legality, or enforceability of the remaining provision or parts of the provision of the Contract Documents, which shall remain in full force and effect as if the unenforceable provision or part were deleted.

13.6 No Waiver

13.6.1 The failure of either Design-Builder or Owner to insist, in any one or more instances, on the performance of any of the obligations required by the other under the Contract Documents shall not be construed as a waiver or relinquishment of such obligation or right with respect to future performance.

13.7 Headings

13.7.1 The headings used in these General Conditions of Contract, or any other Contract Document, are for ease of reference only and shall not in any way be construed to limit or alter the meaning of any provision.

13.8 Notice

13.8.1 Whenever the Contract Documents require that notice be provided to the other party, notice will be deemed to have been validly given (i) if delivered in person to the individual intended to receive such notice, (ii) four (4) days after being sent by registered or certified mail, postage prepaid to the address indicated in the Agreement, or (iii) if transmitted by facsimile, by the time stated in a machine generated confirmation that notice was received at the facsimile number of the intended recipient.

13.9 Amendments

13.9.1 The Contract Documents may not be changed, altered, or amended in any way except in writing signed by a duly authorized representative of each party.

13.10 No Third Party Beneficiary

13.10.1 It is expressly understood and agreed that the enforcement of the terms and conditions of the Contract, and all rights of action relating to such enforcement, shall be strictly reserved to the Owner and the Design-Builder, and that nothing contained in the Contract shall give or allow any claim or right of action by any other or third person under the Contract. It is the express intention of the Owner and the Design-Builder that any member of the public, subcontractor, supplier, material man, tradesman, vendor or other person or entity other than the Owner or the Design-Builder receiving services or benefits under the Contract shall be deemed to be an incidental beneficiary only. The foregoing shall not, however, impair Owner's status as a third party beneficiary of subcontracts of any tier for the performance of work or delivery of services, material or equipment to the Project.

13.11 Labor and Prevailing Wages

13.11.1 The Design-Builder, its agents, and employees shall be bound by and comply with applicable provisions of the California Labor Code and Federal, State, and local laws related to labor. The Design-Builder shall strictly adhere to the provisions of the California Labor Code. The Design-Builder shall forfeit to the Owner the penalties prescribed in the California Labor Code for violations. In accordance with the California Labor Code, the District has on file and will publish a schedule of prevailing wage rates for the types of work to be done under the Contract. The Design-Builder shall not pay less than these rates.

13.11.2 Each worker shall be paid subsistence and travel as required by the collective bargaining agreements on file with the State of California Department of Industrial Relations. The Design-

Builder's attention is directed to Section 1776 of the California Labor Code which imposes responsibility upon the Design-Builder for the maintenance, certification, and availability for inspection of such records for all persons employed by the Design-Builder or subcontractor in connection with the project. The Design-Builder shall agree through the Contract to comply with this Section 1776 and the remaining provisions of the California Labor Code. The Design-Builder shall comply with all DIR regulations, including but not limited to, DIR registration.

13.12 Payroll Records

13.12.1 Design-Builder and each subcontractor performing any portion of the Work under this Contract shall keep an accurate record, showing the name, address, social security number, work classification, straight time and overtime hours for each day and week, and the actual per diem wages paid to each journeyman, apprentice, worker, professional, salaried, or other employee employed by him or her in connection with the Work.

13.12.2 The payroll records of Design-Builder and each subcontractor (including payroll records for professional or salaried employees) shall be certified and shall be available for inspection at the principal office of Design-Builder.

13.12.3 Design-Builder shall file a certified copy of the payroll records (including those applicable to professional and salaried employees) with Owner within ten (10) days after receipt of a written request from Owner.

13.12.4 Design-Builder shall inform Owner of the location of said payroll records, including the street address, City and County, and shall, within five (5) working days, provide a notice of change of location and address of said payroll records.

13.12.5 In the event of noncompliance with the requirements of this clause, Design-Builder shall have ten (10) days in which to comply subsequent to receipt of written notice specifying in what respect it must comply. Should noncompliance exist after said ten (10) day period, Design-Builder shall, be subject to a fee of Fifty Dollars (\$50.00) for each calendar day, or portion thereof, for each worker to whom the noncompliance pertains, until strict compliance is effectuated. Design-Builder acknowledges that, without limitation as to other remedies of enforcement available to Owner, upon the request of the Division of Apprenticeship Standards or the Division of Labor Standards Enforcement of the California Department of Industrial Relations, such penalties shall be withheld from progress payments then due Design-Builder. The Design-Builder shall comply with all laws regarding requirements for certified payrolls, including but not limited to, uploading of certified payrolls.

13.13 Local Hiring

13.13.1 Design-Builder and Subcontractors shall comply with the local codes, which is incorporated into the contract by reference. The SBMC specifically requires the District's contractors and their subcontractors to make good faith efforts to hire qualified individuals who are local residents, as workers on District public works projects valued greater than the limit for formal bidding (as set forth in Laws and Regulations) unless prohibited by Laws or Regulations.

13.13.2 Design-Builder and listed Subcontractors in the Subcontractor's Form must complete and submit to the Owner, after the award of the Contract and prior to Owner's issuance of the Notice to Proceed, the form entitled, "Good Faith Effort Statement for Local Hire," as contained in the Bidding Documents.

13.13.3 Design-Builder must also complete and submit to the Owner, on a weekly basis, documentation of local hiring. The "Local Hire Residency Compliance" for (Attachment D in the RFP) must be submitted with certified payrolls.

13.13.4 Failure to comply with any of the provisions of the SBMC, including the maintenance of records, shall be deemed a breach of the contract and may result in the Contractor being declared “non-responsible” by the Owner and ineligible for the award of future Owner contracts.

13.14 Labor Discrimination

13.14.1 Attention is directed to the following sections of the Labor Code:

13.14.1.1 Section 1735. No discrimination shall be made in the employment of persons upon Public Works because of race, color, national origin or ancestry, or religion of such persons and every Contractor for Public Works violating this section is subject to all the penalties imposed for a violation of this chapter.

13.14.1.2 Section 1420. It shall be unlawful employment practice, unless based upon a bona fide occupational qualification, or except where based upon applicable security regulations established by the United States or the States or the State of California: for an employer, because of the race, religious creed, color, national origin, or ancestry of any person, to refuse to hire to employ him/her or to bar or to discharge from employment such person, or to discriminate against such person in compensation or in terms, conditions or privileges of employment.



*This Design Build Agreement
has been developed in conjunction with
and endorsed by the
Water Design Build Council.*



DESIGN-BUILD AGREEMENT FOR WATER AND WASTEWATER PROJECTS

Document No. 545

First Edition 2016
© Design-Build Institute of America
Washington, DC



Design-Build Agreement for Water and Wastewater Projects

This document has important legal consequences. Consultation with an attorney is recommended with respect to its completion or modification.

This **AGREEMENT** is made as of the _____ day of _____ in the year of 2022, by and between the following parties, for services in connection with the Project identified below:

OWNER:

West Valley Water District
855 W. Base Line Road
Rialto, California 92376

DESIGN-BUILDER:

PCL Construction, Inc.
3750 Schauffele Ave., Suite 270
Long Beach, CA 90808

PROJECT:

(Include Project name and location as it will appear in the Contract Documents)

Oliver P. Roemer Water Filtration Facility Upgrades and Expansion Project
Contract No.:

ADDRESS:

3010 N. Cedar Avenue
Rialto, California 92377

In consideration of the mutual covenants and obligations contained herein, Owner and Design-Builder agree as set forth herein.

1372443.4 RM 7473.002 DBIA Document No. 545

Article 1

General

- 1.1 Duty to Cooperate.** Owner and Design-Builder commit at all times to cooperate fully with each other, and proceed on the basis of trust and good faith to permit each party to realize the benefits afforded under this Agreement.
- 1.2 Definitions.** Terms, words and phrases used in this Agreement shall have the meanings given them in DBIA Document No. 535, *Standard Form of General Conditions of Contract Between Owner and Design-Builder* (2010 Edition) ("General Conditions of Contract").
- 1.3 Design Services.** Design-Builder shall, consistent with applicable state licensing laws, provide design services, including architectural, engineering, and other design professional services required by this Agreement. Such design services shall be provided through qualified, licensed design professionals who are either (i) employed by Design-Builder, or (ii) procured by Design-Builder from independent sources. Nothing in this Agreement is intended to create any legal or contractual relationship between Owner and any independent design professional.

Article 2

Design-Builder's Services and Responsibilities

2.1 General Services.

2.1.1 Owner has provided Design-Builder with Project background documents, including but not limited to, the Design Criteria Report and 30% Design Drawings, depicting the Owner's program requirements and objectives for the Project, collectively referred to as the Basis of Design Documents. Owner's Basis of Design Documents include conceptual documents, design specifications, design performance specifications, and other technical materials and requirements prepared by or for Owner.

2.1.2 Prior to the execution of Contract, Design-Builder has advanced the Owners' 30% Design, and has provided additional, different and innovative approaches to the design and construction of the Project, upon which the Design-Builder has provided a fixed Design-Build price.

2.1.3 Design-Builder shall have the sole and exclusive responsibility and liability for the design, construction and performance of the Project, notwithstanding the information contained in the Owner's Project background documents, and to ensure compliance with all applicable Governmental Rules, Regulations, and Requirements.

2.1.4 Design-Builder shall supervise, coordinate, and direct the Work using Design-Builder's best skill and attention. Design-Builder shall be solely responsible for, and have control over, the entire design effort, construction means, methods, techniques, sequences, procedures, and the coordination of all portions of the Work.

2.1.5 Design-Builder shall be responsible for inspection of all portions of the Work and to determine that such portions conform to the requirements of the Contract Documents and are ready to receive subsequent Work.

2.1.6 Design-Builder shall take field measurements, verify field conditions, and carefully compare with the Contract Documents such field measurements, conditions, and other information known to Design-Builder before commencing the Work. Errors, inconsistencies, or omissions discovered at any time shall be promptly reported in writing to the Owner. By proceeding with the Project the Design-Builder accepts the conditions of the Project.

2.1.7 All work performed in connection with this Contract shall be performed in a manner consistent with the standard of care ordinarily exercised by those who provide architectural, engineering, planning and design services for projects of similar size, scope and complexity for water treatment facilities in the United States, and consistent with the standard of care ordinarily exercised by those who specialize in such specialty services. In addition, all work is to be performed within the standard of care for California architects, engineers, planners and designers. Neither review nor approval of Design-Builder's work by Owner, any employee, any agent/consultant of Owner, or any other person shall in any way relieve Design-Builder from its duty to utilize this standard of care in the performance of its duties. Design-Builder agrees to provide its professional services in a manner that is in the Owner's economic and governmental best interests, consistent with this standard of care and the Design-Builder's professional obligations.

2.2 Phased Services.

2.2.1 Design Services. Design-Builder shall perform the services of design and other services for the Project based on the Basis of Design Documents and the Design-Builder's progressed design submitted and accepted by Owner, upon which the fixed Design-Build price is based. Design-Builder shall perform such services to the level of completion required for Design-Builder to complete the Project.

2.2.2 Construction Services. Design-Builder's construction services shall consist of the completion of design services for the Project, the procurement of all materials and equipment for the Project, the performance of construction services for the Project, the start-up, testing, and commissioning of the Project, the provision of warranty services, and all other services necessary to complete the Project.

2.3 **Proposal.** Design-Builder has provided a proposal to Owner (the "Proposal") for the completion of the design and construction for the Project for the Contract Price, and is made a part of this Agreement.

Article 3

Contract Documents

3.1 **The Contract Documents are comprised of the following:**

- 3.1.1** Permits
- 3.1.2** Properly Executed Change Orders
- 3.1.3** Addenda
- 3.1.4** Executed Design-Build Agreement (DBIA Document No. 545), including Exhibits
- 3.1.5** General Conditions (DBIA Document No. 535)
- 3.1.6** Design-Builder's Proposal / Fixed Design-Build Price Proposal
- 3.1.7** Technical Specifications
- 3.1.8** Design Criteria Report
- 3.1.9** Project Plans/Drawings (detailed plans having greater precedence)

3.1.10 Request for Proposals

Article 4

Interpretation and Intent

- 4.1** Design-Builder has carefully reviewed all the Contract Documents, including the various documents comprising the Owner's Project background documents for any conflicts or ambiguities. Design-Builder and Owner will discuss and resolve any identified conflicts or ambiguities prior to execution of the Agreement.
- 4.2** The Contract Documents are intended to permit the parties to complete the Work and all obligations required by the Contract Documents within the Contract Time(s) for the Contract Price. The Contract Documents are intended to be complementary and interpreted in harmony so as to avoid conflict, with words and phrases interpreted in a manner consistent with construction and design industry standards. In the event inconsistencies, conflicts, or ambiguities between or among the Contract Documents are discovered after Owner's acceptance of the Proposal, Design-Builder and Owner shall attempt to resolve any ambiguity, conflict, or inconsistency informally, recognizing that the Contract Documents shall take precedence in the order in which they are listed in Section 3.1 hereof. In case of a conflict within a part of a Contract Document, the provision with the more restrictive/most stringent interpretation shall govern.
- 4.3** Terms, words, and phrases used in the Contract Documents, including this Agreement, shall have the meanings given them in the General Conditions of Contract.
- 4.4** The Contract Documents form the entire agreement between Owner and Design-Builder and by incorporation herein are as fully binding on the parties as if repeated herein. No oral representations or other agreements have been made by the parties except as specifically stated in the Contract Documents.

Article 5

Ownership of Work Product

- 5.1** **Ownership.** All Work Products originated and prepared by Design-Builder or its sub-contractors of any tier under this Contract shall be and remain the property of Owner for its use in any manner it deems appropriate. However, any use unintended under the Contract, or modification or alteration of the Work Products without the direct involvement of the Design-Builder shall be without Liability to Design-/Builder. Work Products are all works, tangible or not, created under this Contract for Owner including, without limitation, documents, material, data, reports, manuals, specifications, artwork, drawings, sketches, computer programs and databases, schematics, photographs, video and audiovisual recordings, sound recordings, marks, logos, graphic designs, notes, websites, domain names, inventions, processes, formulas, matters and combinations thereof, and all forms of intellectual property therein. To the extent applicable under the U.S. Copyright Act, all works created by Design-Builder under this Contract are work-made-for-hire created for the sole benefit and ownership of Owner. Owner hereby grants to Design-Builder a license, revocable at will of Owner, to use and copy such documents during the term of this Contract for the sole purpose of performing the Services. All copies of tangible materials or writings embodying such intellectual properties shall be turned over to Owner upon termination of this Contract or completion of work pursuant to this Contract. Design-Builder hereby assigns, and agrees to assign to Owner, all goodwill, copyrights and trademarks in all Work Products originated and prepared by Design-Builder under this Contract. Design-Builder further agrees to execute any documents necessary for Owner to perfect, memorialize, or record Owner's ownership of rights provided herein. This paragraph shall survive expiration or termination of this Contract.

- 5.2 Obligations on Subcontractor.** Any sub-contract entered into by Design-Builder relating to this Contract, to the extent allowed hereunder, shall include a like provision (on Owner's ownership in Work Products) for work to be performed under this Contract to Contractually bind or otherwise oblige its subcontractor performing work under this Contract such that Owner's ownership rights of all Work Products are preserved and protected as intended herein. Failure of Design-Builder to comply with this requirement or to obtain the compliance of its subcontractor with such obligations shall subject Design-Builder to all remedies allowed under law and termination of this Contract.
- 5.3 Use of Work Products and Trade Secrets by Third Parties.** Design-Builder shall not make available, provide or disclose any Work Product to any third party without prior written consent of Owner. Design-Builder further agrees that it will not disclose nor cause others to disclose any of Owner's trade secrets or other potentially patentable matters including inventions, discoveries, improvements, and methods, developed during the performance of this Contract. Design-Builder shall be liable for any loss of patentable rights as a result of such disclosure whether such disclosure is inadvertent or not.
- 5.4 Non-Infringement Warranty.** Design-Builder hereby represents and warrants that performance of all obligations under this Contract does not infringe in any way, directly or contributorily, upon any third party's intellectual property rights, including, without limitation, patents, copyrights, trademarks, trade secrets, right of publicity and proprietary information. This section shall survive expiration or termination of this Contract.
- 5.5** In Design-Builder's defense of the Owner Defendants, negotiation, compromise, and settlement of any such infringement Action, the Owner shall retain discretion in and control of the litigation, negotiation, compromise, settlement, and appeals therefrom.
- 5.6** Where any Work Product furnished by Design-Builder is in a form of software or firmware ("Vehicle"), and if any part of the such Vehicle (a) becomes the subject of an Action, (b) is adjudicated as infringing a third party's Intellectual Property right, or (c) has its use enjoined or license terminated; Design-Builder shall, with the Owner's consent, do one of the following immediately. Design-Builder shall at its expense either:
1. Procure for the Owner the right to continue using said part of the Vehicle; OR
 2. Replace the Vehicle with a functionally equivalent, non-infringing product.
- Exercise of any of the above-mentioned options shall not cause undue business interruption to the Owner or diminish the intended benefits and use of the Work Product by the Owner under the specifications herein.
- 5.7** Rights and remedies available to the Owner hereinabove shall survive the expiration or other termination of this Contract. Further, the rights and remedies are cumulative of those provided for elsewhere in this Contract and those allowed under the laws of the United States, the State of California, and the County of San Bernardino. This Paragraph shall survive the expiration or other termination of this Contract.
- 5.8** Unless expressly stated otherwise, for all pre-existing third-party and Design-Builder's intellectual property (if any), including software, required to operate or use any Work Product delivered by Design-Builder, Design-Builder hereby grants and will cause others to grant Owner (including its agents and consultants) an irrevocable license to use such pre-existing intellectual property internally by Owner (including its agents and consultants).

Article 6

Contract Time

- 6.1 Date of Commencement.** The Design Services shall commence within five (5) days of Design-Builder's receipt of Owner's Notice to Proceed for Design Services unless the parties mutually agree otherwise in writing. The Construction Services shall commence within five (5) days of Design-Builder's receipt of Owner's Notice to Proceed for Construction Services ("Date of Commencement").
- 6.2 Substantial Completion and Final Completion.**
- 6.2.1** Substantial Completion of the entire Work shall be achieved no later than 28 months (852) calendar days after the Date of Commencement ("Scheduled Substantial Completion Date").
The parties agree that the definition for Substantial Completion set forth in Section 1.2.37 of the General Conditions of Contract applies.
- 6.2.2** Final Completion of the Work or identified portions of the Work shall be achieved as expeditiously as reasonably practicable. Final Completion is the date when all Work is complete pursuant to the definition of Final Completion set forth in Section 1.2.19 of the General Conditions of Contract.
- 6.2.3** All of the dates set forth in this Article 6 ("Contract Time(s)") shall be subject to adjustment in accordance with the General Conditions of Contract.
- 6.3 Time is of the Essence.** Owner and Design-Builder mutually agree that time is of the essence with respect to the dates and times set forth in the Contract Documents.
- 6.4 Liquidated Damages.** Design-Builder understands that if Substantial Completion is not attained by the Scheduled Substantial Completion Date, Owner will suffer damages which are difficult to determine and accurately specify. Design-Builder agrees that if Substantial Completion is not attained by the Scheduled Substantial Completion Date (the "LD Date"), Design-Builder shall pay Owner three thousand nine hundred dollars (\$3,900) as liquidated damages for each calendar day that Substantial Completion extends beyond the LD Date.
- 6.4.1 Scheduled Plant Shutdowns.** In addition to the Substantial Completion date, the Design-Builder understands and agrees that achieving and adhering to scheduled plant shutdowns are of the essence, and the Owner shall assess Liquidated Damages, as it is and will be impractical and extremely difficult to ascertain the actual damages which the Owner will sustain in the event of and by reason of such delay. Liquidated Damages will be assessed for each day or partial day beyond the scheduled plant shutdown as follows: for each day or partial day beyond the scheduled plant shutdown in June, July, August, or September, the LD amount shall be six thousand two hundred dollars (\$6,200); for all other days or partial days beyond the scheduled plant shutdown, the LD amount shall be four thousand six hundred (\$4,600). Owner shall have the right to deduct said Liquidated Damages from any amount due or that may become due the Design-Builder, or to collect such Liquidated Damages from the Design-Builder, its Guarantor, or its surety. These Liquidated Damages shall not be construed as a penalty. Design-Builder agrees that any progress payment made after a scheduled plant shutdown, or Substantial Completion, shall not constitute a waiver of Liquidated Damages.

Article 7

Contract Price

7.1 Contract Price.

7.1.1 Owner shall pay Design-Builder a total fixed Design-Build price in accordance with Article 6 of the General Conditions of Contract the sum of fifty nine million, one hundred and sixteen thousand, eight hundred and seventy-one dollars (\$59,116,871), subject to adjustments made in accordance with the General Conditions of Contract. The Contract Price is deemed to include all sales, use, consumer and other taxes mandated by applicable Legal Requirements.

7.2 Allowance Items and Allowance Values.

7.2.1 Any and all Allowance Items, as well as their corresponding Allowance Values, are set forth in the Contract Price Amendment or the Proposal.

7.2.2 Design-Builder and Owner have worked together to review the Allowance Items and Allowance Values based on design information then available to determine that the Allowance Values constitute reasonable amounts for the Allowance Items. Design-Builder and Owner will continue working closely together during the preparation of the design to develop Construction Documents consistent with the Allowance Values.

7.2.3 No work shall be performed on any Allowance Item without Design-Builder first obtaining in writing advanced authorization to proceed from Owner. Where Allowance Item work authorized by the Owner exceed the Allowance Value, Owner and Design-Builder shall execute a Change Order.

7.2.4 The Allowance Value includes the direct cost of labor, materials, equipment, transportation, taxes, and insurance associated with the applicable Allowance Item. All other costs, including design fees, Design-Builder's overall project management and general conditions costs, overhead and Fee, are deemed to be included in the original Contract Price, and are not subject to adjustment notwithstanding the actual amount of the Allowance Item. unless otherwise agreed to in writing.

7.2.5 Price proposals, and for scopes of work requested by Owner for each allowance item of work, shall be provided to and approved by Owner prior to the Design-Builder commencing such work. The Design-Builder shall provide price quotes within seven (7) days of receipt of request by Owner. Price proposals should clearly indicate if the Allowance Item will be performed on a lump sum, unit price, time and materials, or combination thereof, basis. Further, the price proposals shall be provided in a format that clearly itemizes all labor quantities and labor rates, material quantities and material rates, equipment costs, general conditions and fee to perform the work of the Allowance. Any work performed by subcontractors to the Design-Builder shall also be itemized as above. Price quotes shall be obtained from Owner-selected subcontractors and/or vendors by the Design-Builder in a format that clearly itemizes all labor quantities and labor rates, material quantities and material rates, equipment costs, general conditions and fee to perform the Allowance scope of work. Any work performed by subcontractors to Owner selected subcontractor and/or Vendor shall also be itemized.

Article 8

Procedure for Payment

8.1 Contract Price Progress Payments.

8.1.1 Design-Builder shall submit to Owner on the fifth(5th) day of each month, beginning with the first month after the Date of Commencement, Design-Builder's Application for Payment in accordance with Article 6 of the General Conditions of Contract and an updated project schedule showing all project activity (past, present, and future).

8.1.2 Owner shall make payment within thirty (30) days after Owner's receipt of each properly submitted, accurate, and approved by the Owner Application for Payment in accordance with Article 6 of the General Conditions of Contract, but in each case less the total of payments previously made, and less amounts properly withheld under Section 6.3 of the General Conditions of Contract. Except as provided for under the California prompt pay statutes, the Design-Builder shall not charge and the Owner shall not be liable for any late fees or interest.

8.2 Retainage on Progress Payments.

8.2.1 Five percent (5%) of each Progress Payment will be retained until the Design Build Work has been completed and accepted by Owner per the Contract Documents. After fifty percent (50%) of the Design Build Work has been completed, including approved Change Orders, the Design-Builder may request a reduction in the withholding of retention. Owner will review the progress to date and the remaining Work. If it appears that the Design Build Work will be successfully completed and is progressing on schedule, Owner may at its sole discretion, reduce the retention on subsequent Design Build Work. Thereafter, Owner may, at its complete discretion, and in a fashion which protects the interest of Owner, increase the retention but in no event, to more than a 5% retention.

8.2.2 Substitution of Securities. At the request and expense of the Design-Builder, in accordance with California Public Contract Code Section 22300, in lieu of Owner withholding the five percent (5%) retention, the Design-Builder may: (1) substitute a deposit of securities at least equivalent to the retention to be paid, or (2) request Owner to pay retention directly to an escrow agent. If the Design-Builder requests that retention be paid into an escrow account, the Design-Builder and Owner shall enter into an escrow agreement in the exact form set forth in the Public Contract Code Section 22300. All forms or correspondence pertaining to Security Deposit in Lieu of Withhold shall be addressed to Owner for review by the legal counsel for Owner.

8.3 Final Payment. Design-Builder shall submit its Final Application for Payment to Owner in accordance with Section 6.6 of the General Conditions of Contract. Owner shall make payment on Design-Builder's properly submitted and accurate Final Application for Payment (less any amount the parties may have agreed to set aside for warranty work) in accordance with prevailing law, provided that: (a) Design-Builder has satisfied the requirements for final payment set forth in Section 6.6.6 of the General Conditions of Contract.

8.4 Record Keeping and Finance Controls. Design-Builder shall keep full and detailed accounts and exercise such controls as may be necessary for proper financial management, using accounting and control systems in accordance with generally accepted accounting principles and as may be provided in the Contract Documents. During the performance of the Work and for a period of three (3) years after Final Payment, Owner and Owner's accountants shall be afforded access to, and the right to audit from time to time, upon reasonable notice, Design-Builder's records, books, correspondence, receipts, subcontracts, purchase orders, vouchers, memoranda, and other data relating to the Work, all of which Design-Builder shall preserve for a period of three (3) years after Final Payment. Such inspection shall take place at Design-Builder's offices during normal business hours unless another location and time is agreed to by the parties.

Article 9

Termination for Convenience

- 9.1** The Owner, through its Board of Directors, may terminate for convenience any part of the remaining work under the Contract at any time, or from time to time, by written notice to the Design-Builder. Such notice shall specify the extent to which the performance of work is terminated and the effective date of such termination.
- 9.1.1** Upon receipt of such notice, the Design-Builder shall:
- 9.1.1.1** Immediately discontinue work on the date and to the extent specified in the notice and place no further orders or subcontracts for materials, services, or facilities, other than as may be required for completion of such portion of work that is not terminated;
- 9.1.1.2** Promptly obtain cancellation upon terms satisfactory to Owner of all purchase orders, subcontracts, rentals or any other contracts existing for the performance of the terminated work or assign those contracts to Owner as directed;
- 9.1.1.3** Assist Owner in the maintenance, protection, and disposition of work in progress, plant, tools, equipment, property, and materials acquired by the Design-Builder or furnished by the Design-Builder under this Contract; and
- 9.1.1.4** Complete performance of the Work which is not terminated.
- 9.1.2** Upon any such termination, the Design-Builder shall waive any claims for damages on account thereof; but as the sole right and remedy of the Design-Builder, Owner shall pay Design-Builder substantiated costs in accordance with the following:
- 9.1.2.1** All amounts due and not previously paid to the Design-Builder for work completed in accordance with the Contract prior to such notice of termination, and for work thereafter completed as specified in such notice, up to but not exceeding the contract value for the work using the progress schedule, schedule of values and other project controls as applicable;
- 9.1.2.2** Reasonable costs incurred in demobilization and the disposition of residual material, plant and equipment; and
- 9.1.2.3** There shall be no claim or right to lost profits on unperformed work under any theory or any circumstances. There shall be no other right or claim for loss, cost, damage, expense or liability. These limits apply to a termination for convenience and also to any termination for default subsequently determined wrongful and therefore treated as a termination for convenience.
- 9.1.3** Design-Builder shall submit within twenty-one (21) days after receipt of notice of termination a proposal for an adjustment to its compensation including all incurred costs described herein. Should the logistics of such a termination preclude pricing any item of cost, the Design-Builder shall estimate costs to the best of its ability. Owner shall review, analyze, and verify such proposal, and negotiate an equitable adjustment, subject to Board of Director approval as needed, and the Contract shall be amended in writing accordingly.
- 9.1.4** No compensation will be paid to the Design/Builder for unabsorbed or under absorbed overhead, nor shall the Design-Builder be paid for loss of anticipated profits in any form.
- 9.1.5** If an agreement cannot be reached concerning an equitable adjustment, Owner may issue a unilateral Change Order.

Article 10

Representatives of the Parties

10.1 Owner’s Representatives.

10.1.1 Owner designates the individual listed below as its Senior Representative (“Owner Senior Representative”), which individual has the authority and responsibility for avoiding and resolving disputes under Section 10.2.3 of the General Conditions of Contract: *(Identify individual’s name, title, address, and telephone numbers.)*

10.1.2 Owner designates the individual listed below as its Owner’s Representative, which individual has the authority and responsibility set forth in Section 3.4 of the General Conditions of Contract: *(Identify individual’s name, title, address, and telephone numbers.)*

10.2 Design-Builder’s Representatives.

10.2.1 Design-Builder designates the individual listed below as its Senior Representative (“Design-Builder’s Senior Representative”), which individual has the authority and responsibility for avoiding and resolving disputes under Section 10.2.3 of the General Conditions of Contract: *(Identify individual’s name, title, address, and telephone numbers.)*

10.2.2 Design-Builder designates the individual listed below as its Design-Builder’s Representative, which individual has the authority and responsibility set forth in Section 2.1.1 of the General Conditions of Contract: *(Identify individual’s name, title, address, and telephone numbers.)*

Article 11

Bonds and Insurance

11.1 Insurance. Design-Builder and Owner shall procure the insurance coverages set forth in the Insurance Exhibit attached hereto and in accordance with Article 5 of the General Conditions of Contract.

11.2 Bonds and Other Performance Security. Design-Builder shall provide the following performance bond and labor and material payment bond or other performance security:

Performance Bond.

Required Not Required

Payment Bond.

Required Not Required

Article 12

Other Provisions

12.1 Listing of Exhibits and documents incorporated herein as part of this Agreement:

- Exhibit A - Design Criteria Report
- Exhibit B - Scope of Services – Section 1.4 of the RFP
- Exhibit C - List of Reference Documents – Section 1.5 of the RFP
- Exhibit D - Design-Builder's Proposal and fixed Design-Build Price
- Exhibit E - Permits and Approvals
- Exhibit F - Supporting Pricing Information
- Exhibit G - Key Firms and Key Personnel
- Exhibit H - Insurance Terms
- Exhibit I - Drinking Water State Revolving Fund (DWSRF) Loan Requirements
- Exhibit J - Water Infrastructure Finance and Innovation Act (WIFIA) Requirements
- Exhibit K - Form of Performance Bond
- Exhibit L - Form of Payment Bond
- Exhibit M - Wage Determination Schedules
- Exhibit N - Project Labor Agreement

DBIA Document No. 535, Standard Form of General Conditions of Contract Between Owner and Design-Builder (2010 Edition) ("General Conditions of Contract")

Article 13

Limitation of Liability

13.1 Limitation of Consequential Damages. Except as otherwise provided in the Section 6.4 "Liquidated Damages " and 535 General Conditions Article 7 "Indemnification" and reserving to Owner any rights it may have therefore, the Design-Builder and the Owner agree that they mutually waive any claims for consequential damages. This mutual waiver includes:

13.1.1 Damages incurred by Owner for rental expenses; for losses of use, income, profit, financing, business and reputation; and for loss of management or employee productivity or for the services of such persons.

13.1.2 Damages incurred by the Design-Builder for home and/or principal office expenses of every sort whatsoever, including, without limitation, the compensation of personnel stationed there; for loss of financing; impairment of bonding capacity; loss of business and reputation; loss related to goodwill; and for loss of profit.

13.1.3 This Section is not a limitation on Design-Builder's indemnity obligations or damages covered by insurance.

OWNER:

DESIGN-BUILDER:

(Name of Owner)

(Name of Design-Builder)

(Signature)

(Signature)

(Printed Name)

(Printed Name)

(Title)

(Title)

Date: _____

Date: _____