



WEST VALLEY WATER DISTRICT
855 W. Base Line Road Rialto, CA
PH: (909) 875-1804 FAX: (909) 875-1849

**ENGINEERING, OPERATIONS AND PLANNING COMMITTEE MEETING
AGENDA**

WEDNESDAY, MARCH 11, 2020 - 6:00 PM

BOARD OF DIRECTORS

Greg Young, Director
Kyle Crowther, Vice President

NOTICE IS HEREBY GIVEN that West Valley Water District has called a meeting of the Engineering and Planning Committee to meet in the Administrative Conference Room, 855 W. Base Line Road, Rialto, CA 92376.

- 1. CONVENE MEETING**
- 2. PUBLIC PARTICIPATION**

The public may address the Board on matters within its jurisdiction. Speakers are requested to keep their comments to no more than three (3) minutes. However, the Board of Directors is prohibited by State Law to take action on items not included on the printed agenda.

3. DISCUSSION ITEMS

- a.** Updates to Engineering, Operations and Planning Committee.
 1. Rialto-Colton Basin Groundwater Council.
 2. San Bernardino Basin Area Groundwater Council.
 3. IEUA Meter Equivalent Charge Collection Request.
- b.** Approval to Negotiate Contract with GHD Inc. for Professional Engineering Design Services for the 16 MGD Oliver P. Roemer Water Filtration Facility Ultimate Expansion Project.
- c.** Consider a Joint Use Agreement with Caltrans for Transmission Pipelines Crossing the 210 Freeway at Cactus Avenue in the City of Rialto.
- d.** Consider a Reimbursement Agreement with the Lytle Development Company for Construction of a 30-inch Transmission Pipeline.
- e.** Consider Notice Of Completion Recordation for The Construction of The Bloomington Area Waterline Replacement Phase 3A Project.

- f. Consider a Common Use Agreement with the City of Rialto for the Cactus Trail.
- g. Consider Removal of APN 175-170-040 and 175-200-001 from West Valley Water District Service Area.
- h. Consider An Agreement With Evoqua Water Technologies for The Well 41 Ion Exchange Treatment Project Resin Installation.

4. ADJOURN

DECLARATION OF POSTING:

I declare under penalty of perjury, that I am employed by the West Valley Water District and posted the foregoing Engineering, Operations and Planning Committee Agenda at the District Offices on March 6, 2020.

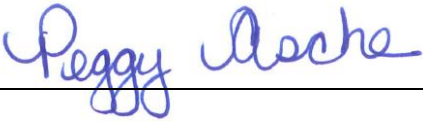

Peggy Asche, Executive Assistant



**BOARD OF DIRECTORS
ENGINEERING AND PLANNING COMMITTEE
STAFF REPORT**

DATE: March 11, 2020
TO: Engineering and Planning Committee
FROM: Clarence Mansell Jr., General Manager
SUBJECT: APPROVAL TO NEGOTIATE CONTRACT WITH GHD INC. FOR PROFESSIONAL ENGINEERING DESIGN SERVICES FOR THE 16 MGD OLIVER P. ROEMER WATER FILTRATION FACILITY ULTIMATE EXPANSION PROJECT

DISCUSSION:

supply to supplement overdrafted groundwater basins, West Valley Water District (“District”) is planning to expand treatment capacity at the Oliver P. Roemer Water Filtration Facility (“Roemer WFF”) to allow the treatment of an additional 16 million gallons per day (MGD) of State Water Project water. It is understood that the Roemer WFF expansion will be constructed in phases, but that the ultimate 16 MGD Roemer WFF design will be completed as part of this expansion design project. Currently, the Roemer WFF operates at its maximum capacity of 14.4 MGD during peak summer water usage.

The increase in treatment capacity will require an analysis of existing facilities and an evaluation and recommendation of feasible and cost effective treatment options and operational strategies. The delivery method will be a Design Build (“DB”) that will utilize an integrated team to develop the design and construct the facility.

On December 4, 2019, the District posted a Request for Qualifications (“RFQ”) on Planet Bids for qualified and experienced engineering firms to provide professional Engineering Design Services for the District’s 16 mgd Roemer WFF Expansion Project. Interested firms were requested to submit their Statement of Qualifications (“SOQ”) to present their expertise and experience associated with Professional Engineering Design services as it relates to the intended project. Below is the scope of services defined in the RFQ:

- Review available reports and data applicable to the project
- Conduct an environmental review of the project and develop a permitting plan
- Identify, evaluate and present reasonably feasible treatment technology alternatives
- Develop 30% design documents under a progressive Design Build delivery model
- Prepare a probable construction cost estimate based on the 30% design
- Prepare the project implementation schedule and potential phased project construction
- Develop the Design Build Request for Qualifications and the Request for Proposals package
- Provide Design Build support and construction observation services during construction

- Provide general coordination with, and oversight of, the entity designated as the DB firm
- Act as the “Owners Agent” during the Design Build phase of the project

On January 22, 2020 the District received two (2) SOQ’s. One from Carollo Engineers, Inc. and one from GHD Inc. The SOQs submitted were evaluated, scored, and ranked based on the criteria specified in the RFQ by a selection committee formed by the District. Following the evaluation, interviews with the two firms were conducted.

Based on technical qualifications and overall evaluation, it is determined that GHD Inc. best serves the District’s interest and needs for this project. They bring a senior team of individuals with extensive DB and treatment process experience. GHD Inc. is a leader in infrastructure engineering with more than 10,000 employees and 200 offices worldwide. They have had a local presence in Southern California since 1951 and have offices in Moreno Valley, Los Angeles, Long Beach, Irvine and San Diego. They have a long history working with municipalities and agencies and have \$1.3 billion in recent Southern California projects. Attached as Exhibit A, is the SOQ submitted by GHD Inc.

The next step is to enter into negotiations with the recommended consultant for a Professional Services Agreement with a specific scope of work, budget, and schedule. Should negotiations fail with the recommended firm, the District may enter into negotiations with the District’s selection for second most qualified firm. A contract for the scope of services identified will be negotiated and a Professional Services Agreement and Task Order will be brought back to the Engineering, Operations and Planning Committee for review and approval.

FISCAL IMPACT:

There is no fiscal impact at this time. A Professional Services Agreement and Task Order for the scope of services identified will be brought back to the Engineering, Operations and Planning Committee for review and approval.

STAFF RECOMMENDATION:

It is recommended that the Engineering, Operations and Planning Committee authorize fee negotiations with GHD Inc. and have this item considered by the full Board of Directors at a future meeting.

Respectfully Submitted,



Clarence Mansell Jr, General Manager

LJ:ce

ATTACHMENT(S):

1. Exhibit A - SOQ for GHD

EXHIBIT A



West Valley Water District

Statement of Qualifications

Professional Engineering
Design Services for the
16 MGD Oliver P. Roemer
Water Filtration Facility
Expansion Project

Jamal Awad, PhD, PE
Project Manager
320 Goddard Way, Suite 200
Irvine, CA 92618

P 949.585.5235 F 949.648.5299
E Jamal.Awad@ghd.com

January 22, 2020

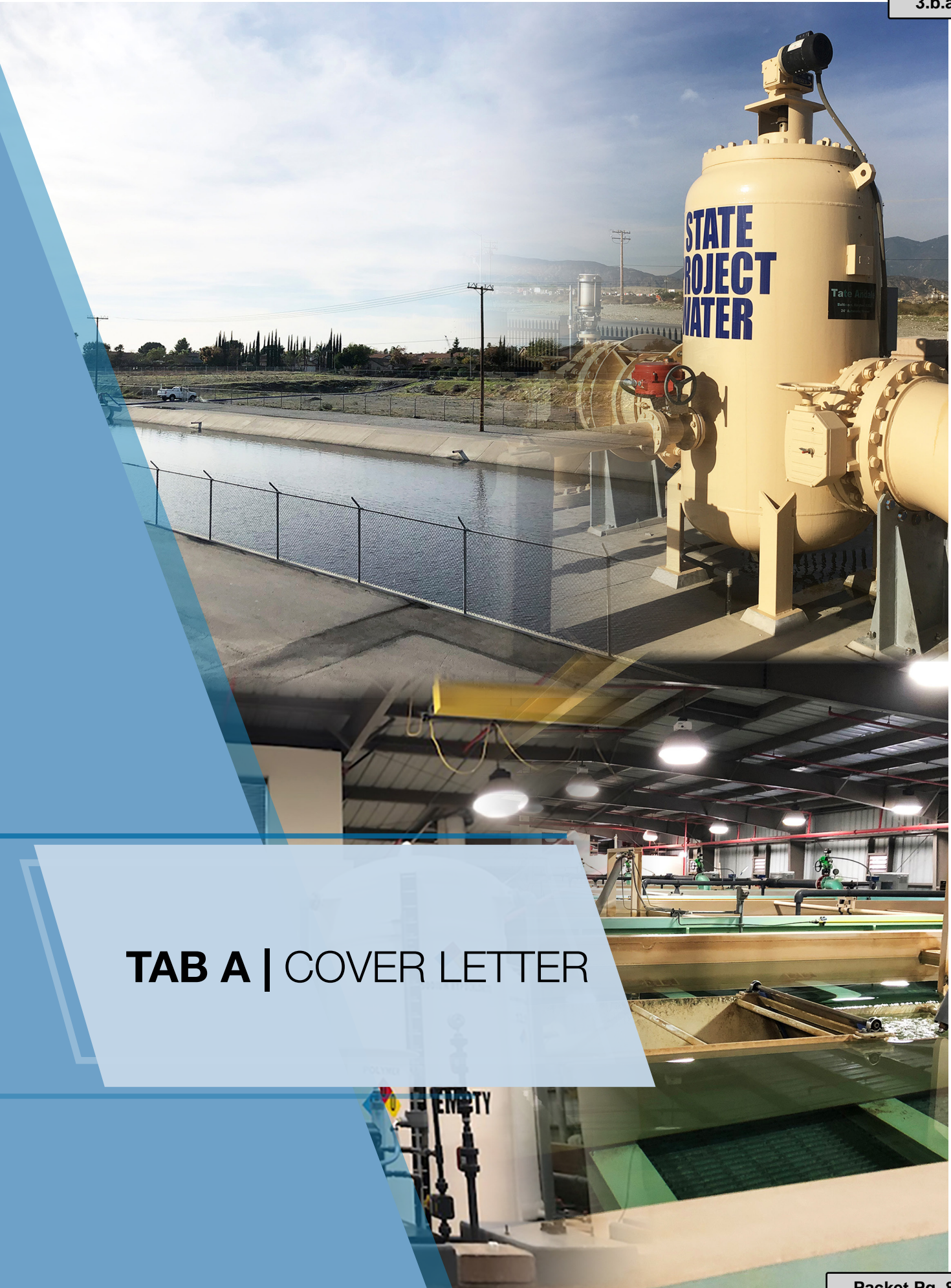

TAB A | COVER LETTER

A Cover Letter



January 22, 2020

Al Robles, Purchasing Supervisor
West Valley Water District
855 W. Base Line Road
Rialto, CA 92376

GHD Proposal No. 11207439

Statement of Qualifications - Professional Engineering Design Services for the 16 MGD Oliver P. Roemer Water Filtration Facility (WFF) Expansion Project

Dear Mr. Robles and Members of the Selection Panel:

The WFF Expansion Project (Project) will be a significant investment by the West Valley Water District (District) that will add 16 MGD of treatment capacity to accommodate projected population growth. The delivery method will be Progressive Design-Build (PDB) that will utilize an integrated team to develop the design and construct the facility. The Owner's Engineer (OE) will have a significant role in setting the design definition, evaluating alternatives, developing the 30% design documents, and driving the PDB process. An experienced, creative OE with the ability to capitalize on the unique features of the Plant while maintaining its reliability and redundancy will be critical to the success of the project.

The GHD team is comprised of PDB experts that have been on both sides of the equation as both OE's, and Design-Builders, so we fully appreciate and respect the process. This deep understanding allows us to help provide practical solutions that protect the District and are fair and reasonable to the PDB Entity thereby developing a true project partnership. This, of course, is the key to providing the District with the most cost-effective expansion that meets and exceeds the intended performance criteria. We relish the opportunity to participate in this journey and feel strongly that we can bring tremendous value to the District as your OE.

Unparalleled Team Experience in Progressive Design-Build

GHD is the preeminent OE Consulting Firm in California. We were OE on the recently completed WRD GRIP project and are currently OE on Doheny Desalination Plant, the Arcadia WTP expansion for the City of Santa Monica, and the completed Carlsbad Desalination Plant. We bring a senior team of individuals with extensive PDB experience, knowledge of regulations pertaining to current drinking water standards and constituents of concern, process expertise, an understanding of project risk, and the experience to coordinate design, construction, start-up and commissioning activities. In addition we have extensive experience in the planning and design of all treatment processes including the preliminary coagulation/flocculation/plate settling treatment, Trident System, Trojan UV, Calgon GAC, and MF/UF Membranes.

Our project team is comprised of local engineers and global experts with an extensive background in water treatment, regulatory requirements, alternative project delivery, construction, and operations and maintenance. Our proposed Project Manager, **Jamal Awad, PhD, PE**, was the Deputy OE/Technical Services Lead for WRD's recently completed \$115M PDB GRIP AWTF and had significant responsibilities in establishing project technical requirements, coordinating technical reviews of the Design-Build Entity submittals, and negotiating DDW requirements for the project. He is a technical matter expert in both the Trident Treatment System (the subject of his PhD Thesis) and UV disinfection (being a founding member of the International UV Association). Jamal permitted the first UV for primary disinfection in California at Eastern Municipal Water District with the same UV reactor configuration to those at the WFF.

Mark Donovan, PE will be our proposed Design Manager and Senior Process Engineer. He brings over 20 years of experience in membrane-based water treatment system process design. He has provided full-scale system design, operations support, and treatment process improvement/optimization services to municipal and industrial membrane water treatment facilities worldwide. Mark also brings significant membrane manufacturing experience valuable during the membrane selection.

Two additional senior level staff included **Hector Ruiz, PE**, and **Chris Hertle**. Hector was General Manager of the Trabuco Canyon Water District for over 10 years and has an extensive background in Operations & Maintenance and Asset Management and will serve as Senior Advisor. Chris is GHD’s Global Market Lead for Water, and has significant experience in delivering OE services and detailed knowledge of GHD’s global technical resources and will serve as the Blue Ribbon Panel Chair. All of these individuals above are based in Irvine, CA.

Blue Ribbon Panel of Experts

A Blue Ribbon Panel, led by Chris, will be comprised of Global experts that will provide insight and wisdom to the District and project team. Their early project guidance will be invaluable in setting a solid foundation for the project success. The panel includes a suite of experts from consulting engineering, academia, and operations with specialized knowledge in treating State Project Water. However, the composition of the Panel can be easily expanded based on project’s needs and further discussions with the District.



Blue Ribbon Panel

Chris Hertle (Chair), MPhil – Adjunct Professor - Advanced Water Management Center Uni of Qld
GHD Global Market Lead

Michael Chapman - GHD Lead Water Treatment Expert

Sun Liang, PhD, PE - MWD of Southern California Water Purification Engineer

James Borchartd, PE – Stantec Water Treatment Expert and Contributor to MWH Water Treatment Principles and Design (3rd Edition)

Bill Bellamy, PhD, PE - Adjunct Professor and Deputy Director of the Center of Excellence in Produce Water Management; University of Wyoming/Former CH2M HILL Water Treatment Expert

Rhodes Trussell, PhD, PE – Co-Author of MWH Water Treatment Principles and Design (3rd Edition)

Jim Vickers, PE – Membranes Expert and President of SPI

Maximizing the Use of Existing Facilities

GHD has completed a preliminary analysis of the existing WFF. Our preliminary findings indicate that there may be significant reliability and redundancy in the existing facility. These features are unmatched by any plant treating State Project Water and offer the District significant advantages in delivering this 16 MGD expansion. A few of our ideas for consideration to capitalize on some of these features, while maintaining overall reliability of the Plant, are described below.



Treatment Unit	Opportunity	Benefit	Additional Flow (MGD)	Detail
Preliminary Treatment	Excess capacity	Ability to treat additional flow	7.2 MGD	Plant was designed for extra 7.2 MGD
	Stress test to push more capacity	Treat more than the extra 7.2MGD	Additional 8.8 MGD	Achieve 30.4 MGD with existing facilities, if no significant impact on TOC removal
UV disinfection	Replace 6L24 with 4L24 reactors	Achieve target treatment capacity and reduce power consumption	16 MGD	Achieve target capacity of 30.4 MGD by simple reactor replacements
GAC adsorbers Currently treats 1/3 flow ~ 5MGD	16 MGD	Achieve target capacity of	10 MGD	Change from series operation to parallel
New membrane filtration plant	30.4 MGD by simple reactor replacements	Significantly reduced Capital costs and simple operation	16 MGD	Install another 7 Trident filters

GHD is a global firm with a local team that is committed to successfully achieving the District's goals and acting as a seamless extension of your staff. We value our relationship with the District and believe that we are the right team for this project. It is our goal to exceed your expectations and we are fully dedicated to delivering the full suite of OE services to the District. GHD intends to adhere to the provisions described in this RFQ and certifies that the SOQ was prepared independently and was submitted without any collusion designed to limit competition or bidding. Thank you for the consideration and we look forward to serving your needs. Feel free to contact Jamal at 949.585.5235 or Jamal.Awad@ghd.com to answer any questions.

Sincerely,

GHD Inc.

Jamal Awad

Jamal Awad, PhD, PE
Project Manager



Paul Hermann, CPEng
Principal/Vice President

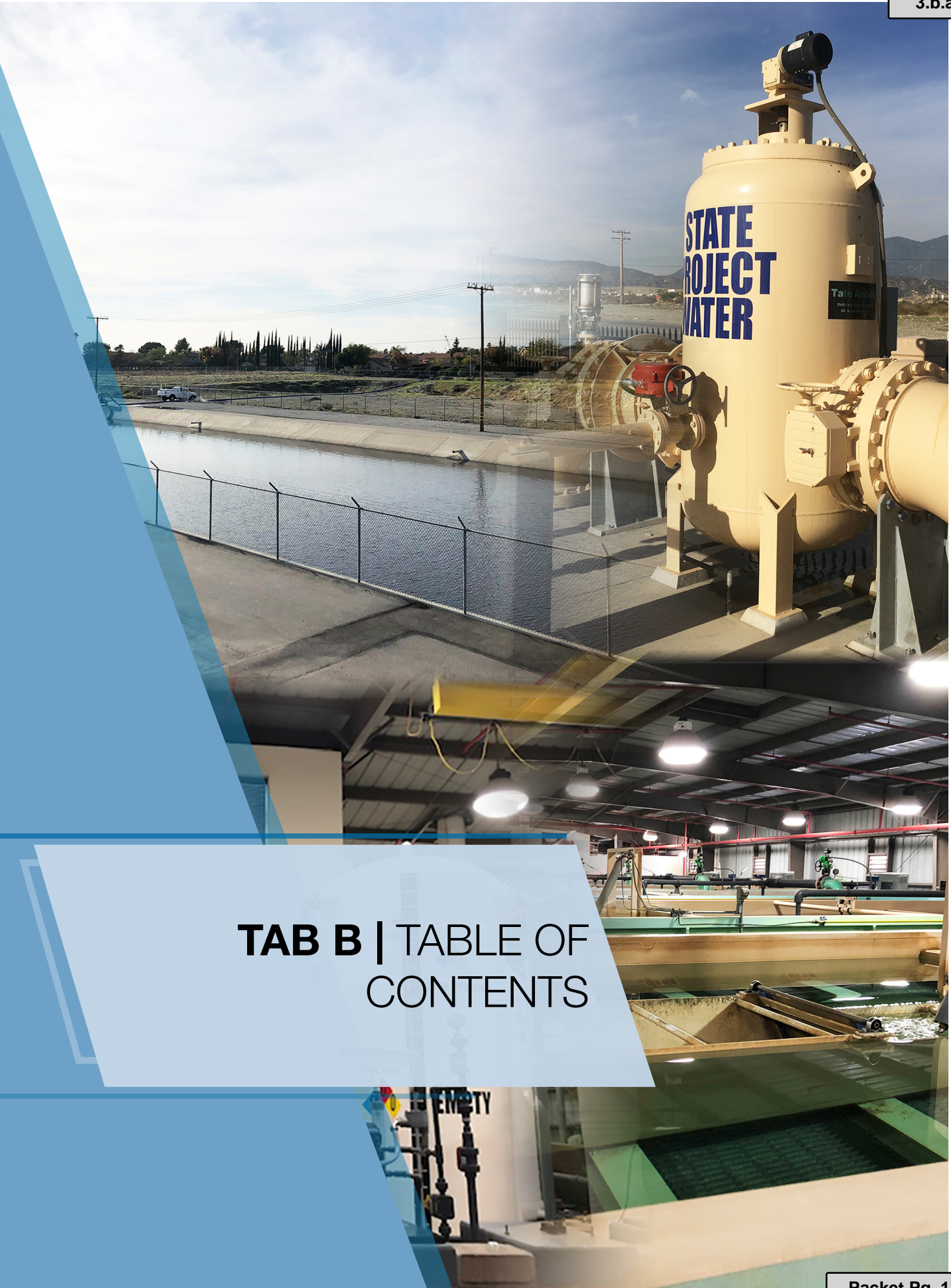

TAB B | TABLE OF CONTENTS

B Table of Contents

- A. Cover Letter
- B. Table of Contents
- C. Company Background **1**
- D. Project Team & Organization **2**
- E. Experience & Record of Past Performance . **8**
- F. Additional Comments & Project Approach **16**
- G. Conflict of Interest **24**
- H. Other Information **24**
- I. WWD Standard Agreement for Professional Services **24**
- J. Rate Sheet **25**

Appendices

Appendix 1. Resumes

Appendix 2. Acceptance Letter

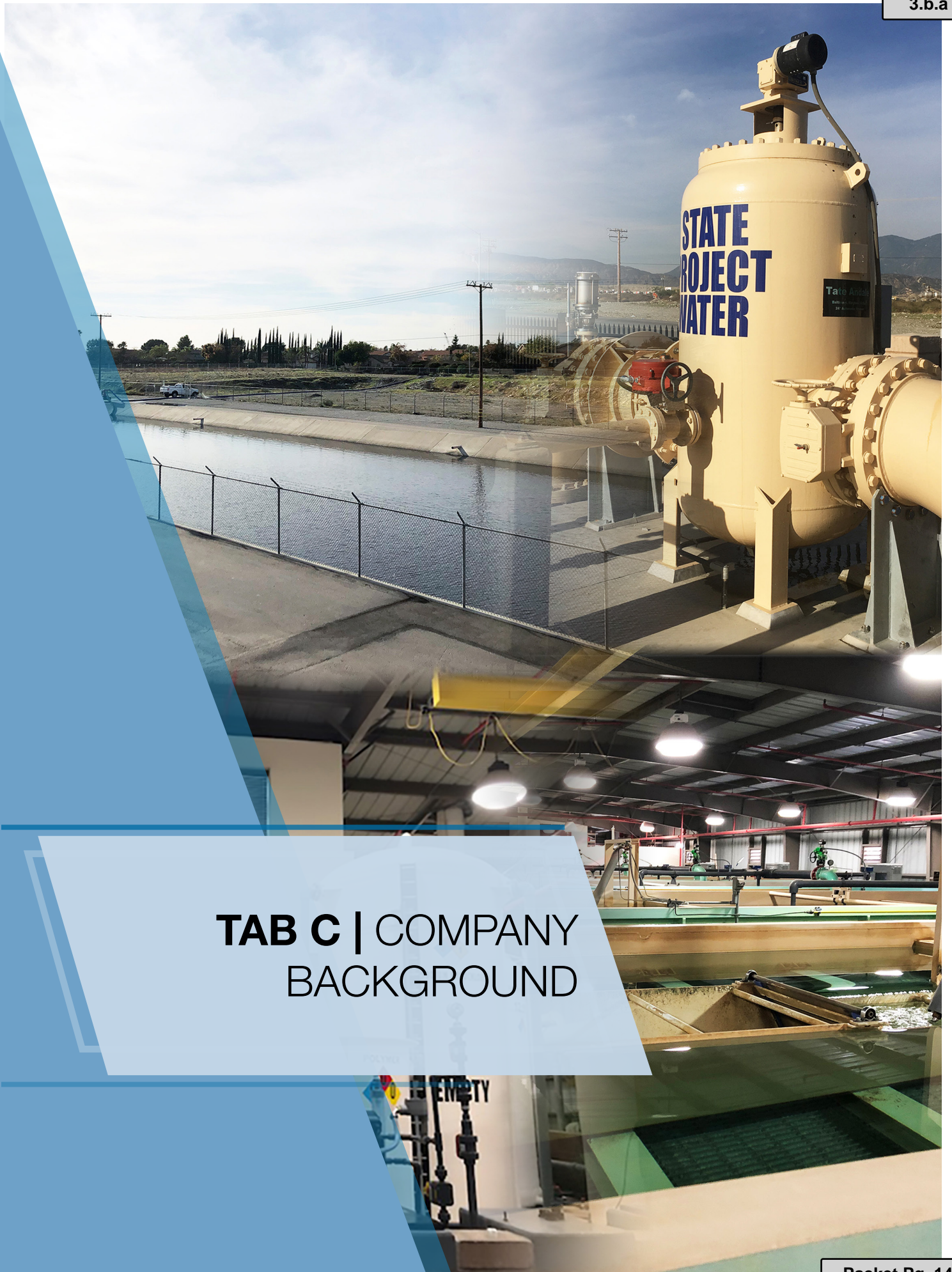

Tab C

**TAB C | COMPANY
BACKGROUND**

C Company Background

GHD is at the forefront of the water industry, delivering sustainable water solutions across the globe. We assist water and wastewater utilities, City departments, and others who provide water services to optimize infrastructure and adapt to environmental changes in ways that balance the needs of our communities.

About GHD

GHD is a leader in infrastructure engineering with more than 10,000 talented professionals and 200 offices worldwide. We have been a provider of multi-disciplined engineering services for over 90 years, through an internationally recognized network of engineers, environmental scientists, and other professionals who together provide high quality environmental and infrastructure engineering. Backed by over 4,000 staff in North America, we deliver complex infrastructure projects of all types, excelling in all forms of water and wastewater civil infrastructure, including pipelines and treatment facilities.

GHD has a positive impact on all of the communities in which we live and work. GHD has had a local presence in Southern California since 1951, and has a long history of success working collaboratively with municipalities and agencies. GHD's Southern California offices currently include Moreno Valley, Los Angeles, Long Beach, Irvine, and San Diego, with a Pasadena office expected to be completed and open by mid 2020. We offer a local presence and a long history of success in the region.

GHD is at the forefront of the water industry, delivering sustainable water solutions across the globe. We assist water and wastewater utilities, City departments, and others who provide water services to optimize infrastructure and adapt to environmental changes in ways that balance the needs of our communities. Our water and wastewater engineering experience of more than 85 years in California includes the planning, required regulatory coordination and permitting, design and construction of water and wastewater projects. Our experienced team works with engineering and operations personnel as well as community stakeholders to understand each site-specific situation to minimize downtime and increase public acceptance.

REGISTERED COMPANY FOR
ISO 9001
ENGINEERING DESIGN

We are passionate about improving safety, enhancing mobility, and preparing a healthy environment for the community at large. The GHD Sustainability Policy provides strategic direction for how we integrate social, economic and environmental issues into core business practices. A member of the World Business Council for Sustainable Development, GHD operates under a Practice Quality Management System, ISO 9001:2015 and an Environmental Management System, ISO 14001:2015 which are certified by Lloyds Register Quality Assurance.

Today, GHD is one of the world's top engineering firms and is recognized by ENR as the 10th largest pure design firm globally, and ranked **#25 on ENR's 2019 Top 500 Design Firms** list.

GHD California Office Locations

- Cameron Park
- Concord
- Emeryville
- Eureka
- Fresno
- Irvine
- Long Beach
- Los Angeles
- Moreno Valley
- Redding
- Roseville
- San Diego
- San Francisco
- San Jose
- San Luis Obispo
- Santa Rosa
- West Valley





**TAB D | PROJECT TEAM &
ORGANIZATION**

Tab D

D Project Team & Organization

The Right Team

Our project team members have been carefully selected to meet the project requirements of experience and work approach to achieve the District's vision.

Our Project Manager, **Jamal Awad, PhD, PE**, will serve as the District's main point of contact. Jamal is uniquely qualified to serve in this role, as demonstrated by his current role as the **Deputy Project Manager/Technical Lead for the GRIP AWTF OE for the Water Replenishment District of Southern California (WRD)**. Jamal led the preparation of the Design Criteria Report which established all the technical requirements for the proposed facilities with enough details for the PDB Entity to develop the guaranteed maximum price (GMP) for the project. The design requirements cover both the design and construction phases as well as the 4-year Transitional Operation Period to be performed by the DB Entity. He is also a technical matter expert in both the Trident Treatment System (the subject of his PhD Thesis) and UV disinfection (being a founding member of the International UV Association). Of note, Jamal permitted the first UV system for primary disinfection in California at Eastern Municipal Water District with the same UV reactor configuration to those at the Oliver P. Roemer Water Filtration Facility.

In support of Jamal will be our Project Advisor, **Hector Ruiz, PE**, who will bring technical insight from a client perspective, having been a **former Head of Engineering and General Manager at Trabuco Canyon Water District**. There will also be **Chris Hertle, MPhil**, the Blue Ribbon Panel Chair, who is **GHD's Global Market Lead for Water**, and has significant experience in delivering OE services and detailed knowledge of GHD's global technical resources.

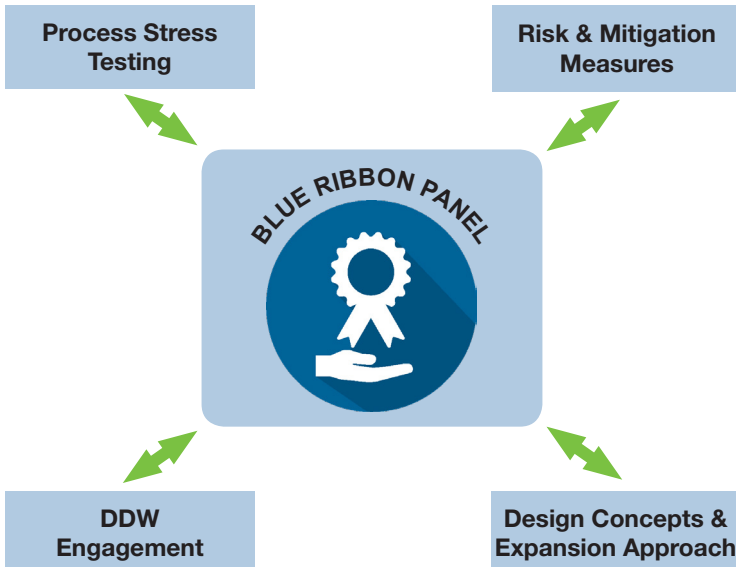

Our Blue Ribbon Panel will benefit the District to assist in guiding the Project Team to maximize existing process capacities and establishing the most reliable and cost effective plan for the 16 MGD expansion.

The Blue Ribbon Panel will include the following key members:

1. **Chris Hertle (Chair), MPhil** – Adjunct Professor Advanced Water Mangment Center, University of Queensland; GHD Global Market Lead
2. **Michael Chapman, CPEng** - GHD Lead Water Treatment Expert
3. **Sun Liang, PhD, PE** - MWD of Southern California Water Purification Engineer
4. **Bill Bellamy, PhD, PE** - Adjunct Professor and Deputy Director of the Center of Excellence in Produce Water Management; University of Wyoming/Former CH2M HILL Water Treatment Expert
5. **James Borchardt, PE** – Stantec Water Treatment Expert and Contributor to MWH Water Treatment Principles and Design (3rd Edition)
6. **Rhodes Trussell, PhD, PE** – Co-Author of MWH Water Treatment Principles and Design (3rd Edition)
7. **Jim Vickers, PE** – Membranes Expert and President of SPI

These Panel members are lead water treatment experts with significant knowledge in treating State Project Water. Their early Project guidance will be invaluable in setting a solid foundation for the Project success. The composition of the Panel can be easily expanded based on Project's needs and further discussions with the District.

The biography summaries of key team members provided on the following pages highlight the multi-disciplined professionals within our project team and identify the project role and responsibilities assigned to them. Each individual on our team was selected based on their capability and experience in achieving success on similar projects.

Detailed resumes for all team members are included in **Appendix 1**.

Our organizational chart on the following page identifies each member of our team structure.

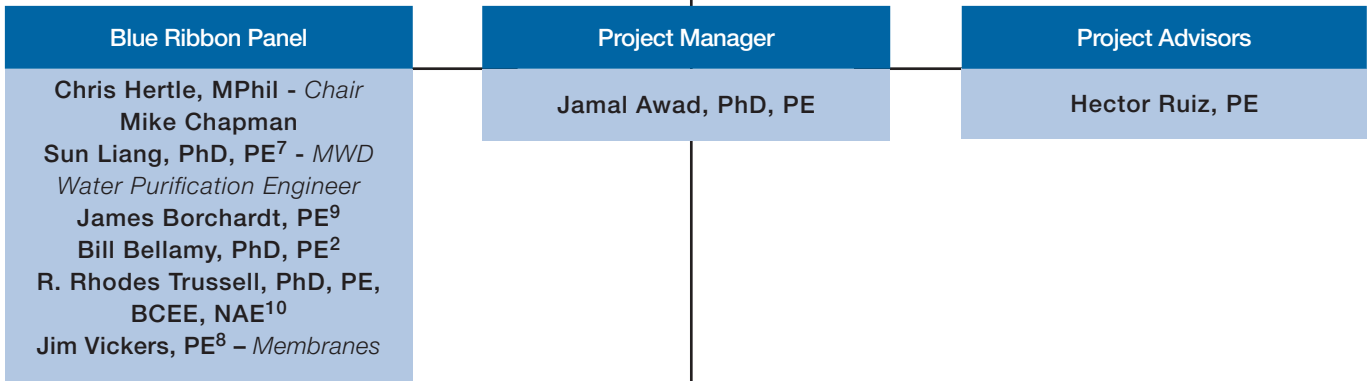

Project Services

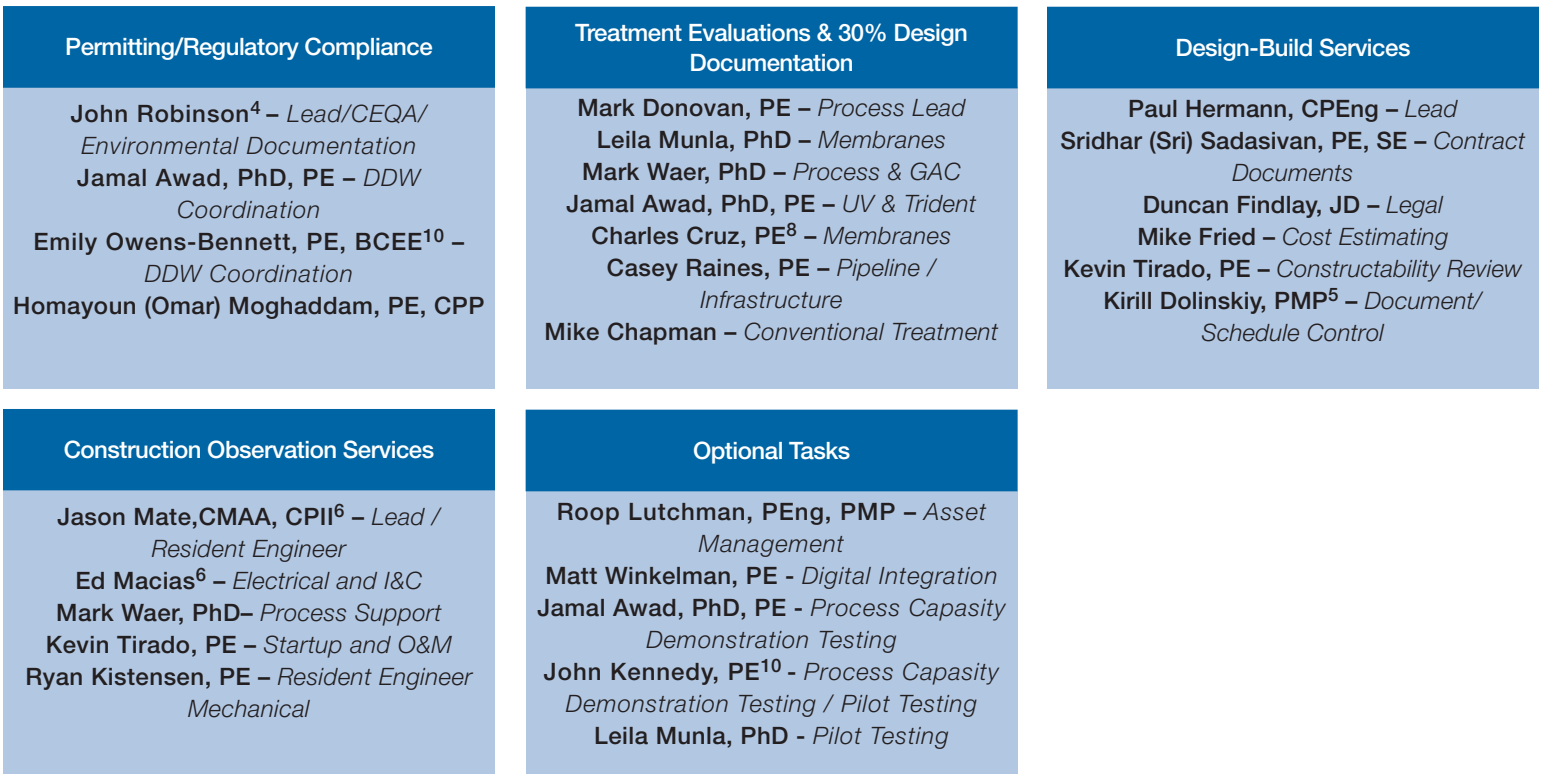

Technical Resources

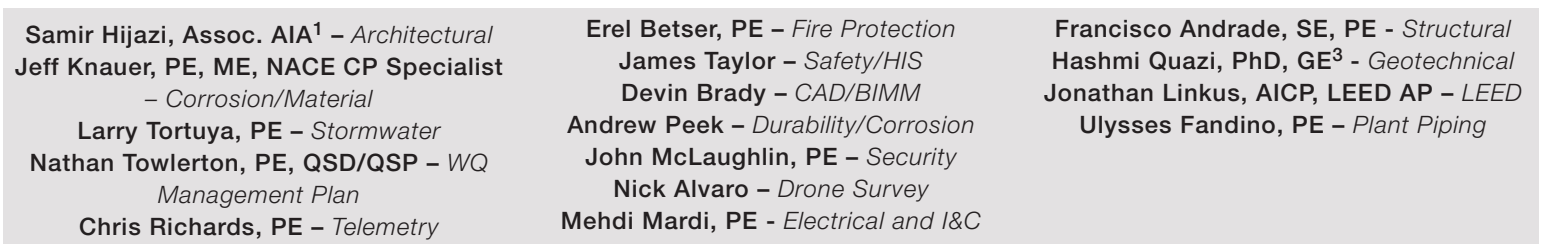

Sub Key		
1 ARCHISSANCE	5 KRD Management Consulting, LLC	9 Stantec
2 Bellamy and Sons, LLC	6 MNS	10 Trussell Technologies, Inc.
3 Converse Consultants	7 MWD of Southern California*	
4 John Robinson, LLC	8 SPI	

* MWD of Southern California's participation to the Project will be non-chargeable.

Subconsultants

Each subconsultant was selected to increase the benefits to this contract and to enhance its successful delivery both within budget and on schedule. GHD has a successful teaming track record with each of the subconsultants listed below.



ARCHISSANCE | ARCHISSANCE is a multi-disciplined design firm offering a wide range of architectural, engineering, interiors, and project management services. Their staff includes licensed architects, professional engineers, interior architects, computer-aided designers, and project managers. The firm has worked closely with GHD on a number of water/wastewater related projects such as the Anaheim Lenain WTP and Water Replenishment District of Southern California GRIP AWTF



MNS Engineers, Inc. | Established in 1962 as a C-Corporation, MNS Engineers, Inc. (MNS) provides quality infrastructure consulting services to the water resources, transportation, and government service markets throughout California. Specializing in the core services of construction management, civil engineering, and land surveying, MNS' reputation has been built on clear and direct communication and quality services.

Bellamy and Sons, LLC | William Bellamy is an adjunct Professor of Practice and Deputy Director of the Center of Excellence in Produce Water Management at the University of Wyoming. William spent 40 years with organizations such as CH2M Hill, Texaco Inc., US Army Environmental Hygiene Agency, US EPA, and adjunct positions at the Colorado State University and University of Colorado. He has been responsible for the assessment, development, and application of new water, wastewater, and reuse technologies. He specializes in research and application of sustainability principles as applied to proven and developing technologies for industrial, government, and municipal clients throughout the globe. Most recently, he has been involved in assisting with the development of solar and conventional desalination, water purification, advanced biological systems, and unique alternative energy use and energy storage.



Separation Processes Inc. | SPI is an SBE firm providing development and application of membranes and advanced processes for municipal and industrial water and wastewater treatment. SPI has provided engineering services for over 20 membrane bioreactor systems and continues to refine the procurement and design process to adapt to the changes in the MBR marketplace. SPI is in a unique position to help with the membrane system prescreening and pre-selection of a membrane system supplier and can refine the process to ensure the District gets the best value for the membrane equipment, which is one of the single most expensive systems on a project.



Converse Consultants | In 1946, Professor Frederick J. Converse established Converse Consultants (Converse) in Pasadena, California to provide the construction industry with geotechnical engineering and geological services. Converse is an employee-owned corporation, with 9 offices and more than 150 employees throughout the United States – California (Monrovia, Redlands, Costa Mesa, Palm Desert and Palmdale), Nevada (Las Vegas, Reno, and Elko), and Pennsylvania.



Stantec | Stantec started in 1954 as a one-person firm, and today, the Stantec community unites approximately 22,000 employees working in over 400 locations across 6 continents. They are designers, engineers, scientists, and project managers, innovating together at the intersection of community, creativity, and client relationships. Trussell Technologies | Trussell Technologies is an environmental engineering firm passionate about developing the best process and water quality solutions. They provide safe and sustainable solutions in water, wastewater, reuse, and desalination for clients and partners and take projects from concept through implementation using past experience, applied research and treatability expertise, proven regulatory insight, cutting-edge treatment system design, and real-world operational knowledge.



John Robinson, LLC | John Robinson Consulting, Inc. is a general consulting firm offering a range of services including a Small Business Enterprise (SBE) certification.

We are a small firm with big experience. John Robinson has over 25 years of consulting and management experience in the private sector for cities, ports, special districts, water districts, wastewater clients and industrial clients.



Trussell Technologies | Trussell Technologies is an environmental engineering firm passionate about developing the best process and water quality solutions. They provide safe and sustainable solutions in water, wastewater, reuse, and desalination for clients and partners and take projects from concept through implementation using past experience, applied research and treatability expertise, proven regulatory insight, cutting-edge treatment system design, and real-world operational knowledge.



KRD Management Consulting, LLC | KRD Management Consulting, LLC provides clients with program and project management, scheduling, cost estimating, reporting, data management, earned value management, construction management services for engineering and construction project and programs. In addition to servicing local clients in South California (San Diego Metro Area, Los Angeles Metro Area, Inland Empire), KRD Management Consulting staff service clients throughout continental United States.



949.585.5235
Jamal.Awad@ghd.com
Irvine, CA

Jamal Awad, PhD, PE | Project Manager

Jamal has over 30 years of extensive experience in water quality, water and wastewater treatment planning, and engineering. He is sought after nationally to support creative implementation of engineering solutions and innovative technologies assessments. Currently, Jamal is the Deputy OE/Technical Lead for the \$115M WRD GRIP AWTF PDB project and has also managed the delivery of the Formatting of the IEUA Front-End Contract Documents and IEUA Engineering Design Guidelines Project which had significant stakeholders' involvement and multiple Workshops to establish IEUA design preferences. In addition to conventional water treatment experience, Jamal is a subject matter expert in both the Trident and Trojan UV treatment systems.

30 Years Experience

Professional Engineer:
California, Wisconsin,
Illinois, Texas, Arizona
CA # C50719

PhD, Environmental
Engineering, Marquette
University; MS, Civil
and Environmental
Engineering, UW-
Madison; BS, Civil
Engineering, Louisiana
Tech University



949.585.5256
Hector.Ruiz@ghd.com
Irvine, CA

Hector Ruiz, PE | Project Advisor

Hector has more than 25 years' experience in water/wastewater engineering, including the oversight and management of water resources and supplies for a water district. As former Head of Engineering and General Manager of Trabuco Canyon Water District, Hector brings the experience of having worked for many years with water and wastewater operators and maintenance technicians in effectively planning and managing the rehabilitation, upgrade, and replacement of an agency's assets, and as such, understands the importance of effective project delivery from an owner's perspective. Hector's experience includes life cycle cost analysis, design, and operation of conventional surface water treatment systems similar to West Valley Water District's Oliver P Roemer WTP, facilities and newer membrane treatment systems for surface water treatment.

25+ Years Experience

Master of Science,
Civil and Environmental
Engineering and
Science, Stanford

University; Bachelor
of Science, Civil
Engineering, California
State Polytechnic
University, Pomona



949.585.5270
Chris.Hertle@ghd.com
Irvine, CA

Chris Hertle, CPEng, BE, MPhil | Blue Ribbon Panel

Chris is a Chemical Engineer with over 35 years' experience in municipal and industrial water and wastewater management. This has covered investigations, pilot plants, design, specification, tendering, installation, commissioning and operations. He has particular interest in the cost effective resource recovery from wastewater. Chris has been involved in the process design of a number of water treatment and water recycling facilities involving the use of micro and ultra-filtration and reverse osmosis. He has presented many papers at national and international forums His extensive experience in delivering OE services will be a significant benefit to the District.

35 Years Experience

Bachelor of
Engineering,
Chemical (Hons),
Master of Philosophy,
Environmental and
Biological Sciences,
Adjunct Professor
– Advanced Water
Management
Centre - University of
Queensland



949.585.5251
Mark.Donovan@ghd.com
Irvine, CA

Mark Donovan, PE | Treatment Evaluation & 30% Design Documentation and Process Lead

Mark is a Senior Process Engineer with over 20 years of experience in membrane-based water treatment system process design. He has provided full scale system design, operations support, and treatment process improvement/optimization services to municipal and industrial membrane water treatment facilities worldwide. Mark has also worked closely with CA Division of Drinking Water engineers to exchange ideas and achieve the ultimate goal of protecting public health while maintaining practical treatment plant design and operational considerations. Mark also brings significant membrane manufacturing experience valuable during the membrane selection.

20+ Years Experience

CA#CH6292

MS, Engineering
(Chemical), California
State University, Long
Beach, California,

BS, Chemical
Engineering, University
of New Hampshire,
Durham, New
Hampshire



John Robinson | Permitting & Regulatory Compliance Lead *(John Robinson, LLC)*

John's over 25 years of environmental engineering experience has focused exclusively on water reclamation, wastewater engineering, and wastewater master plan projects for municipalities in California and Arizona. He has been the Principal-in-Charge or Project Manager for infrastructure projects that include feasibility/master studies and planning, preliminary and final design, bidding, construction management and commissioning. His project experience includes 15 new water reclamation and wastewater facilities, 4 groundwater treatment projects, 300 miles of sewer, potable water and recycled water pipeline designs, 15 pump stations, 12 groundwater wells and 10 reservoirs and 45 master plans for water, sewer and recycled water. He has also served as both a principal in charge as well as program manager for approximately fifty (50) environmental documentation projects.

626.375.9389
jrobinson@johnrobinsonconsulting.com
Pasadena, CA

25 Years Experience

Engineer in Training - CA

BS, Civil Engineering, California State University, Long Beach



Paul Hermann, CPEng | Design-Build Services Lead

Paul is a lead water/wastewater engineer in GHD's Irvine Water Division, with extensive design and construction experience in water/wastewater infrastructure, including large conveyance pipelines, pumping stations and treatment facilities. He has been a design lead engineer for wastewater treatment plant projects that required augmentation and upgrading; with tasks ranging from hydraulic optimizations and design, to equipment replacement and refurbishment. This has involved treatment facilities, inlet works, pre-treatment, pump stations, contact tanks, and drying beds. Paul is currently the OE/Project Manager for the \$115M WRD GRIP AWTF PDB project and the OE Teams Technical Lead on the City of Santa Monica's Arcadia WTP Expansion PDB project.

949.585.5217
Paul.Hermann@ghd.com
Irvine, CA

20 Years Experience

CPEng; RPEQ 09419

Bachelor of Engineering – Civil, Environmental, Queensland University of Technology, Australia



Sridhar Sadasivan, PE, SE | Design-Build Services - Contract Documents

Backed by over 15 years of hands-on experience in design and construction of facilities for environmental projects, Sridhar has been involved in planning, design, and construction of reservoirs, treatment plants, pipelines, pumping stations, and other facilities. Delivery methods have included alternate delivery processes, as well as design-bid-build and roles have included Project Manager, Design Manager, Lead Civil Engineer, and Lead Structural Engineer. Sri has provided construction support and inspection services for several infrastructure projects, including resident engineering services for water infrastructure projects.

858.633.4814
Sridhar.Sadasivan@ghd.com
Moreno Valley, CA

16 Years Experience

Professional Civil Engineer: CA #73525
Professional Structural Engineer: CA #6039

MS, Structural Engineering, University of Cincinnati

BS, Civil/Environmental Engineering, University of Bombay, India



Jason Mate, CMAA, CPII | Construction Observation Services Lead / Resident Engineer *(MNS)*

Jason has more than 12 years of experience in environmental and civil engineering. Jason's roles have ranged from project engineer, resident engineer, to project manager for several large-scale \$500M+ projects involving water/wastewater resources, transportation, and solar energy. Jason has worked directly with GHD for the last few years on the GRIP project, in his role as Resident Engineer.

805.722.0059
jmate@mnsengineers.com
Westlake Village, CA

12 Years Experience

Certified Construction Manager, CMAA; Certified Public Infrastructure Inspector, APWA

BEng, Environmental Engineering, minor in Civil Engineering (Honors), Griffith University, Queensland, Australia



Kevin Tirado, PE | Design-Build Constructability Review

Kevin is committed to streamlining processes and procedures to ensure maximum cost-effectiveness and efficiency. Dedicated professional who builds lasting, productive relationships with leaders of public organizations, private entities, and stakeholders. Technically skilled leader who brings a depth of engineering knowledge to complex business challenges and communicates effectively with "white collar" leadership and "blue collar" teams. Motivational coach and mentor who empowers employees to outperform expectations. Kevin has accepted a position with GHD effective January 27.

1.562.206.7990
Kevin.Tirado@ghd.com
Long Beach, CA

28 Years Experience

CA Civil #C72958

BSCE - University of California, Davis

Committed GHD Team

All team members are available immediately and for the duration of the project. GHD is committed to meeting our proposed project schedule and all milestones. The key individuals listed and identified will be performing the work and will not be substituted with other personnel or reassigned to another project without the District's prior approval.

Team Member	Role	% Dedicated to Current Workload	% Available to 16 MGD Oliver P. Roemer Water Filtration Facility Expansion Project
GHD			
Jamal Awad, PhD, PE	Project Manager	40%	60%
Hector Ruiz, PE	Project Advisor	60%	40%
Chris Hertle, Mphil	Blue Ribbon Panel	75%	25%
Mark Donovan, PE	Treatment Evaluations & 30% Design Documentation - Process Lead	50%	50%
Paul Hermann, CPEng	Design-Build Services Lead	50%	20%
Sridhar (Sri) Sadasiva, PE, SE	Design-Build Services - Contract Documents	10%	10%
Kevin Tirado, PE	Design-Build Services - Constructability Review / Construction Observation Services - Startup & OM	10%	90%
Subconsultants			
Samir Hijazi (ARCHISSANCE)	Technical Services - Architectural	50%	50%
Bill Bellamy (Bellamy and Sons, LLC)	Blue Ribbon Panel	40%	60%
Hashmi Quazi, PhD, GE (Converse Consultants)	Geotechnical	50%	50%
John Robinson (John Robinson, LLC)	Permitting/Regulatory Compliance Lead / CEQA/Environmental Documentation	40%	60%
Kirill Dolinskiy, PMP (KRD Management Consulting, LLC)	Design-Build Services - Document/Schedule Control	60%	40%
Jason Mate, CMAA, CPII (MNS)	Construction Observation Services - Lead/Resident Engineer	20%	80%
Ed Macias (MNS)	Construction Observation Services - Electrical and I&C	70%	30%
Jim Vickers, PE (SPI)	Treatment Evaluations & 30% Design Documentation - Membranes	70%	30%
Charles Cruz, PE (SPI)	Treatment Evaluations & 30% Design Documentation - Membranes	50%	50%
James Borchardt (Stantec)	Blue Ribbon Panel	70%	30%
R. Rhodes Trussell, PhD, PE, BCEE, NAE (Trussell Technologies, Inc.)	Blue Ribbon Panel	70%	30%
Emily Owens-Bennett, PE, BCEE (Trussell Technologies, Inc.)	Regulatory Compliance - DDW Coordination	60%	40%
John Kennedy, PE (Trussell Technologies, Inc.)	Optional Tasks - Process Capacity Demonstration Testing / Pilot Testing	50%	50%

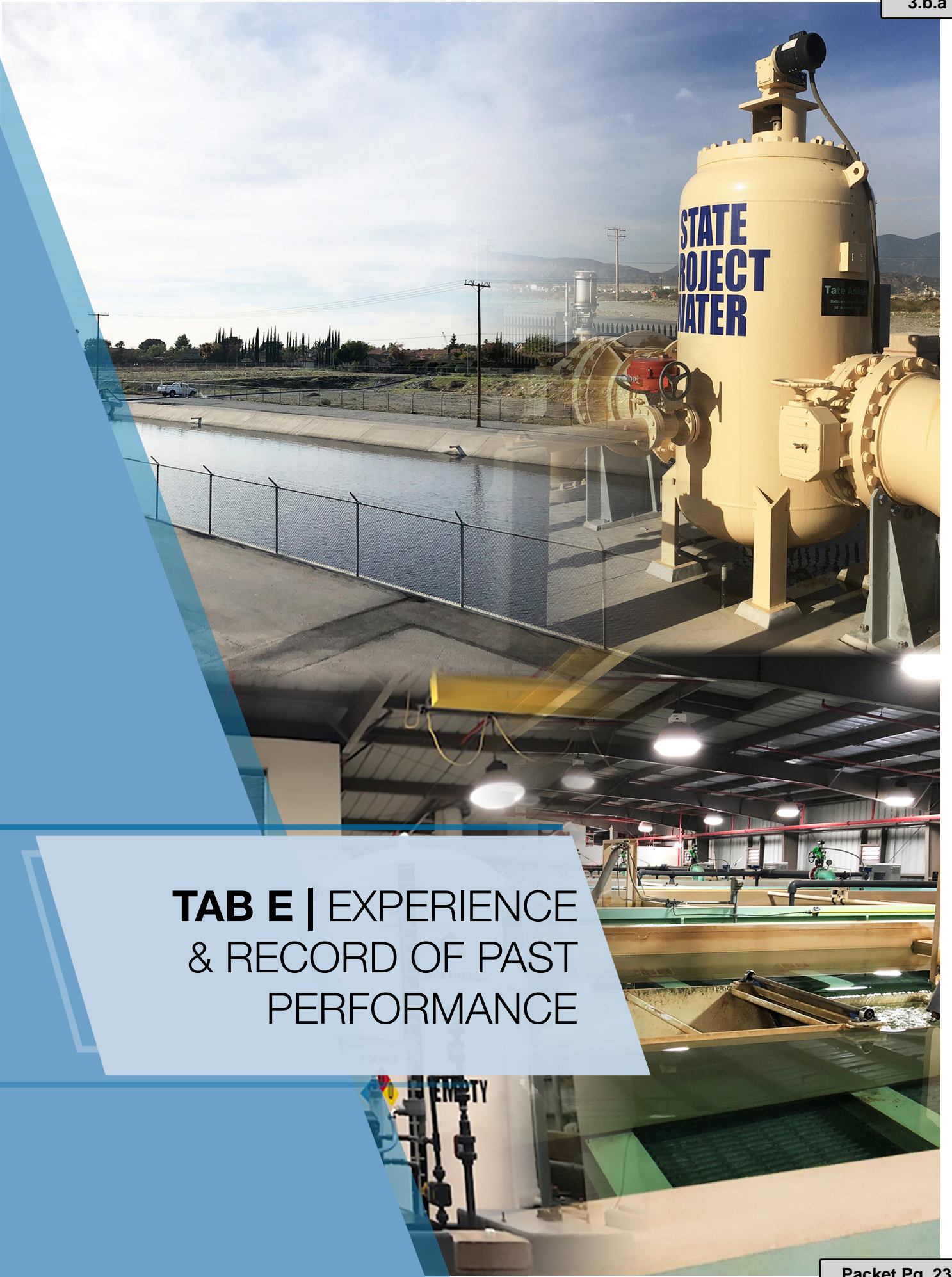

**TAB E | EXPERIENCE
& RECORD OF PAST
PERFORMANCE**

Tab E

E Experience & Record of Past Performance

Through our “One GHD” concept, we are able to draw on expertise from our 10,000+ employees from around the world. Our size, coupled with our global connectivity brings unique value to the District by providing the right people with the right experience; throughout the life of the project.

The GHD Team Features Unparalleled Local OE Experience

GHD is helping clients deliver some of the most significant water system projects in the world. The following projects represent our relevant, recent experience in applying our team’s technical expertise to water treatment projects locally in California. This experience will provide the District with a comprehensive and thorough project based on our established processes and lessons learned over time.

Our project team members have been carefully selected to meet the project requirements for experience and work approach to achieve the District’s vision. Our OE Services Manager, **Jamal Awad**, will serve as the District’s main point of contact. **Jamal is uniquely qualified** to serve in this role, as demonstrated by his current role as the Deputy Project Manager/Technical Lead for the \$115M GRIP AWTF OE for the Water Replenishment District of Southern California (WRD). Jamal led the preparation of the Design Criteria Report which established all the technical requirements for the proposed facilities with enough details for the PDB Entity to develop the guaranteed maximum price (GMP) for the project. The design requirements cover both the design/construction and the 4-year Transitional Operation Period to be performed by the DB Entity. Many of the project team members had significant roles on the GRIP AWTF OE Project as well.

Because the 16 MGD expansion of the District’s WFF include significant existing process capacity determination, process selection (Trident versus membranes), and DDW engagement, **we have assembled a Blue Ribbon Panel of leading experts in all relevant areas for State Water Project water treatment for the benefits of the District. The experience of the Panel members is unmatched by any other team in Southern California.** Our approach includes meaningful workshops with the District staff and the Panel members early in Project implementation in order to maximize such benefits. The District will have the flexibility to add specialty skills to the GHD Team.

As OE’s on previously successful projects, one of GHD’s first tasks is to work with Owner’s staff and Legal Counsel to develop key project milestones with specific budgets. These milestones typically include the following:

- Process Evaluation and Selection
- DDW Engagement and Permitting Plan
- Environmental Documentation
- Project Schedule
- Expression of Interest Documentation
- Statement of Qualifications Documentation
- Design Criteria Report Development
- Concept and / or Preliminary Design
- Project Specific GMP Guidelines
- RFP Documentation
- Design-Build Entity Selection Criteria and Guidelines
- Contract Language Development and Support

Once these milestones are complete, they provide the ground rules for the entire program and essentially serve as the roadmap.

Many of the GHD’s Team members and the Blue Ribbon Panel are local and reside within 60 miles from the District offices and WFF, with the Irvine office having the majority. This physical proximity allows for maximum team interactions and provides considerable accessibility to the District staff.

We have included an Experience Matrix table with project attributes relevant to those required for the District’s 16 MGD WFF Expansion Project. The table is followed by project experience sheets for more in-depth descriptions specific reference projects for the District’s consideration.

Experience Matrix

The GHD team has unmatched OE experience in southern California in the planning, execution, and delivery of both large and small scale water treatment plants and associated infrastructure.

Projects	Project Management - OE and/or Detailed Design	Progressive Design-Build / Alternative Delivery Project	GMP Development	UV Process Design	Surface Water & Groundwater Process Treatment Design	Permitting (City, other stakeholder, etc)	Regulatory Assistance (DDW, etc)	Project Funding	Environmental Documentation Support	Engineering Design Requirements	Contract Documents/ Legal Support	Schedule Control	Constructability Reviews	Construction Cost Estimates	Technical Reviews / Support - All Engineering Disciplines	Construction Management	Pilot Testing	Risk Register and Development	Asset Management	Startup & Commissioning
OE for GRIP AWTF, Water Replenishment District of Southern California	💧	PDB	💧	💧		💧	💧	💧	💧	💧	💧	💧	💧	💧	💧	💧	💧	💧	💧	💧
OE for Doheny Desalination Project, South Coast Water District	💧	ADP			💧	💧	💧	💧	💧	💧		💧		💧			💧	💧		
OE for Carlsbad Ocean Water Desalination Plant, Poseidon Resources	💧	ADP	💧			💧	💧		💧				💧	💧	💧	💧	💧	💧	💧	💧
On-Call Engineering Services, Inland Empire Utilities Agency	💧				💧					💧	💧				💧				💧	
OE for Olympic Well Field Restoration and Arcadia Water Treatment Plant Expansion, City of Santa Monica	💧	PDB	💧	💧	💧	💧	💧		💧	💧	💧		💧		💧		💧	💧	💧	💧
Lenain WTP Master Plan & Rehabilitation and Expansion, City of Anaheim	💧				💧	💧	💧		💧			💧	💧	💧	💧	💧	💧		💧	💧
DB for Otay Water Treatment Plant, Orion Construction	💧	ADP			💧	💧	💧					💧	💧	💧	💧					💧
Reverse Osmosis Water Treatment Plant Rehabilitation, City of Beverly Hills	💧				💧	💧					💧		💧	💧	💧	💧				
OE for Huntington Beach Seawater Desalination, Poseidon Resources	💧	ADP	💧		💧	💧	💧		💧				💧	💧	💧			💧		
Carbon Canyon Water Reclamation Plant, Inland Empire Utilities Agency	💧				💧							💧		💧	💧					
Sustainable Water Infrastructure Project (SWIP) AWTF, City of Santa Monica (SPI Project)		PDB			💧										💧					
Vista Canyon Water Factory, City of Santa Clarita (MNS Project)						💧						💧	💧	💧		💧				💧
Pure Water Monterey Project, Monterey One Water (Trussell Technology Project)	💧			💧		💧	💧		💧	💧		💧		💧	💧		💧			💧
Santa Cruz, Graham Hill Water Treatment Plant (Trussell Technology Project)					💧		💧			💧				💧	💧		💧			💧

Role

Prime since June 2015

Client

Water Replenishment
District of Southern
California
4040 Paramount Blvd,
Lakewood, CA 90712

Reference

Robb Whitaker, PE
General Manager
562 921 5521
rwhitaker@ wrd.org

Project Budget

Projected: \$110M
As-Completed: \$115M

Project Schedule**Milestones**

Office Co-Location
RFI
Design Criteria Report
SOQ
RFP
DB Entity Selection
GMP
Contract Negotiation
DDW Engineering Report
3rd Party Coordination
(SCE; Water Board
Permits)

*All milestones were scoped
with WRD and were
completed on schedule
and within budget.*

Team Members

Jamal A, Mark D, Paul H,
Jason M, Roop L, Leila M,
Mark W, Casey R, Samir
H, Andrew P, Mehdi M,
Francisco A

Relevance

- ✓ Progressive Design-Build
Contract Delivery Method
- ✓ Design Criteria & GMP
Development MF, RO,
UVAOP Process
- ✓ Onsite Groundwater
Injection & Monitoring
Wells
- ✓ Permit Coordination & Title
22 Engineering Report
- ✓ Constructability &
Operations Reviews

OE for Groundwater Reliability Improvement Program Advanced Water Treatment Plant, Water Replenishment District of Southern California

Pico Rivera, CA

GHD, led by Paul Hermann, with Deputy assistance from Jamal, is currently serving as the OE for the Water Replenishment District of Southern California's (WRD's) GRIP Advanced Water Treatment Facility (AWTF) and has served in this capacity for the past 4+ years. The AWTF, with an initial capacity of 13 MGD and an ultimate capacity of approximately 25 MGD, will treat tertiary effluent from the LACSD using ultrafiltration (UF) and reverse osmosis (RO) followed by ultraviolet advanced oxidation (UVAOP). Effluent from the AWTF will be used for groundwater recharge of local drinking water supply. The plant is now online achieving a significant milestone for WRD's water independence from imported water. The project is being delivered via PDB contract delivery, with a construction value of \$115 million. GHD is currently providing construction close out and transitional operations period assistance.

As the OE for the project, GHD prepared all contractual and engineering documents for the selection of the Design-Build (DB) Entity. The engineering documents established the technical and design requirements with enough details for the DB Entity to develop a guaranteed maximum price (GMP) for the proposed project. The design requirements cover both the design/construction and 4-year Transition Operation Period (2 year minimum). The Design Criteria also incorporated the requirements of the District's SCADA Master Plan and the Enterprise Asset Management Master Plan, which was also completed by GHD. These requirements bring significant uniformity and consistency across various District's assets and design and operation of future facilities.

The GRIP UVAOP
utilizes chlorine as an
oxidant to significantly
simplify operations and
reduce cost.

Other **innovative** aspects of this project delivery include:

- A collaborative process to select the DB Entity, during which the shortlisted DBEs submitted preliminary proposals and indicative cost estimates and then participated in several workshops with WRD to refine and enhance their approach. This PDB approach and structure was orchestrated and implemented by the GHD led OE team.
- An architectural design competition that allowed WRD Board and project stakeholders to select the theme for the proposed facility
- The use of innovative "Open-Platform" MF/UF Systems to give the owner greater options for membrane selection in the future and the implementation of a 3rd Stage RO System to maximize plant recovery while allowing for operational flexibility.

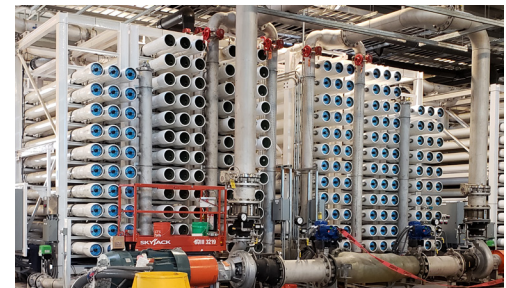

Role

Prime since October 2015

Client

South Coast Water District
31592 West St, Laguna
Beach, CA 92651

Reference

Rick Shintaku,
General Manager
949 499 4555
rshintaku@scwd.org

Project Budget

Projected: \$100M
As-Completed: ~\$100M

Project Schedule**Milestones**

Preliminary Design Report
EIR Engineering Support
Successful Grant Funding
Support
Water Quality in
Distribution System

All milestones were scoped with SCWD and were completed on schedule and within budget.

Team Members

Mark D, Paul H, Jamal A,
Hector R, Mark W, Casey R

Relevance

- ✓ System Integration Considerations
- ✓ Cost Estimating
- ✓ Project Delivery Analysis/ Value for Money Analysis
- ✓ Subsurface Geological Investigations and Water Quality Analysis
- ✓ Technical Support for All Engineering Disciplines
- ✓ Environmental Documentation Preparation & Assistance
- ✓ Preliminary Design
- ✓ Permitting Identification & Development

OE for Doheny Desalination Project, South Coast Water District

Dana Point, CA

GHD, led by Mark Donovan, is currently the OE/Program Manager for South Coast Water District for this 5 -15 MGD ocean desalination project. This ocean desalination project will utilize the California Ocean Plan preferred technologies of a slant well subsurface intake system as well as comingling of RO concentrate with a nearby wastewater ocean outfall for brine disposal. GHD's OE role during this current planning stage of the project includes preparation of the Preliminary Design Report and Project Cost Estimate (including all process elements), site layout and architectural renderings, managing and preparing the Environmental Impact Report and numerous supporting technical studies, and managing the Permitting process. GHD is also leading ongoing discussions with Local and State regulators regarding Ocean Plan Compliance and mitigation requirements, as well as working on local permit requirements.

GHD also provided an evaluation of Project Delivery Methods for the project including development of the project financial model, project risk register and Value for Money Analysis, with several public Board Workshops dedicated to this topic. GHD team members Paul Hermann and Tyler Abercrombie were key contributors to this effort.

Once the project moves into the execution phase, GHD's tasks will include the following:

- Prepare bid documents
- Evaluate all DB/EPC teams
- Perform Construction Management and OE duties through start up and operation
- Assist the District in executing all contracts (up to 3 depending on final risk assessment & Board outcomes {intake wells, conveyance pipeline, plant and discharge pipeline})

As Owner's Engineer, GHD is working with the District to determine the best Alternative Project Delivery model to meet project goals.



Role

Prime since October 2008

Client

Poseidon Water
5780 Fleet Street, Suite
140, Carlsbad, CA 92008

Reference

Patrick Crain,
Project Manager
760 889 2975
pcrain@poseidonwater.com

Project Budget

Projected: \$1B
As-Completed: \$1B

Project Schedule**Milestones**

Design Criteria
Development
Design Submittal Reviews
EPC Proposal Review
EPC Scope and Fee
Review
Startup/Commissioning
Support
3rd Party Coordination
(DDW, SDG&E, NRG)

*All milestones were
scoped with Poseidon
and were completed
on schedule and within
budget.*

Team Members

Paul H, Mark D, Andrew P,
Mark W, Casey R, Mehdi M,
Francisco A

Relevance

- ✓ Design and Cost Estimating
- ✓ Pilot Plant Operation
- ✓ Project Delivery Evaluation and Risk Management
- ✓ Asset Management
- ✓ Construction Management
- ✓ Regulatory Compliance Works, including DDW
- ✓ Environmental Impact Report and Permitting
- ✓ Process Design Reviews
- ✓ Risk Register
- ✓ Technical Support for All Engineering Disciplines

OE for Carlsbad Ocean Desalination Plant, Poseidon Water

Carlsbad, CA

GHD in collaboration with Butier Engineering Inc. were selected by Poseidon Water to provide OE services for the development, construction and commissioning of the 50 MGD Carlsbad Seawater RO Desalination Plant. Poseidon selected the OE team based on a combination of their technical capabilities and past experience in regard to large scale seawater desalination and extensive knowledge of the southern California water infrastructure market.



Early project development work by GHD included evaluation of project cost estimates, evaluation of project risks, and Value Engineering for project optimization.

During the construction phase, GHD provided general oversight and independent assessment of the performance of the Engineering Procurement Construction (EPC) Contractor relative to the contract documents. GHD team members Paul Hermann, Mark Donovan, and Tyler Abercrombie were instrumental in the various phases of this project, including project delivery and risk management, contract development, and execution of this project.

The project was successfully completed in 2015 and the Plant now provides approximately 8% of the water demand for San Diego County. It has become the first large scale desalination plant on the West Coast of the United States. GHD continues to provide an array of ongoing services to Poseidon and SDCWA on this project, including compliance with California Ocean Plan for the new wedgewire screen intake system under development, operations troubleshooting, and CMMS Audit assistance.

GHD Project Team's scope included:

- Early project development works including financial assessment, project delivery optimization, risk management, and contract negotiations
- Technical input to Environmental Impact Report and Environmental Permitting
- Technical works on both the Plant and Conveyance Pipeline
- Desalination facility layout refinement and Value Engineering/Cost Estimating
- Cost model and procurement works
- Process design reviews and extensive approval works with California DDW
- Materials/durability/asset life assistance and compliance reviews
- Pre-treatment pilot testing focused on algal blooms
- Design verifications and Commissioning works
- System integration with other projects/contracts and stakeholder facilities

Role

Prime since August 2018

Client

Inland Empire Utilities Agency

Reference

Jerry L. Burke
Manager of Engineering
(909) 993-1548
jburke@ieua.org

Project Budget

Projected: \$670k
As-Completed: \$670k to date

Project Schedule Milestones

Each Task Order has its own scope and schedule to complete. All milestones for each Task Order were scoped with IEUA and were completed on schedule and within budget.

Team Members

Jamal A, Ryan K, Roop L, Hector R, Casey R, Mehdi M, Francisco A, Duncan F, Mike Fried, Leila M

Relevance

- ✓ Plant Rehabilitation
- ✓ Condition Assessment
- ✓ Asset Management
- ✓ Collection Systems
- ✓ Condition Assessment
- ✓ Contract Documents
- ✓ Engineering Design Guidelines
- ✓ Owner Engineering Services

On-Call Engineering Services

Chino, CA

GHD, led by Jamal Awad as the contract manager, is providing engineering services in support of IEUA's water and wastewater programs on an On-Call basis for a three year period. GHD is performing the task orders in accordance with IEUA's Engineering Design Guidelines, which were also created by GHD. The scope of the task orders encompasses the preparation of design, plans, specifications, cost estimates, and contract documents for capital projects including electrical/instrumentation, process controls, structural design, sewer improvements, water & recycled water improvements and wastewater improvements, constructability reviews, as well as Asset Management. Example task orders performed or being performed under this contract include:

- Technical review of valve submittal for specification compliance (Completed)
- Asset Management Gap Analysis for IEUA (Ongoing)
- Training of IEUA Project Managers on Engineering Design Guidelines and updated Front End Documents (Ongoing)
- Specialty inspections of sewer constructions and CCTV reviews (Ongoing)
- Collection System Asset Management program management support (Ongoing)
- IEUA Engineering Standard Details development (Ongoing)
- Development of asset management specification and spare parts strategy for RP-5 Liquid Treatment System Expansion and RP-5 Solids Treatment Facility Design Services (Ongoing)
- RP-1 modifications to hypochlorite feed facilities (Ongoing)

Much of the services being delivered under this Contract are being delivered in a fashion similar to OE Services and extensions of IEUA staff. Cost and schedule controls, invoicing and status reporting are being performed on each task order for tracking and QA/QC purposes.

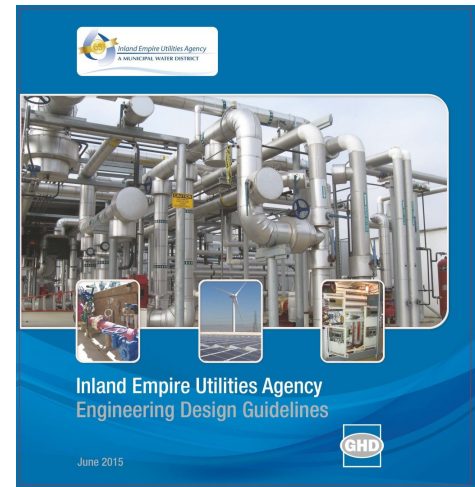

Role

Prime since July 2019

Client

City of Santa Monica

Reference

Sunny Wang
Water Resources Manager
310.458.8230
sunny.wang@smgov.net

Project Budget

Projected: TBD; Still in
GMP Negotiation
As-Completed: \$TBD

**Project Schedule
Milestones**

Environmental
Documentation Support
Selection of DBE
Durability and Asset Life
Requirements
Project Schedule
Development

*All milestones were
scoped with City and were
completed on schedule
and within budget.*

Team Members

Paul H, Mark D, Jamal A,
Mark W, Ryan K

Relevance

- ✓ Progressive Design-Build
Contract Delivery Method
- ✓ Risk Register
- ✓ Environmental Permitting
Assistance

OE for the Olympic Well Field Restoration and Arcadia Water Treatment Plant Expansion

Santa Monica, CA

The City of Santa Monica intends to become water self-sufficient by 2023 through a combination of demand reduction, water conservation and efficiency programs, and the addition of local water supplies as outlined in the City's Sustainable Water Master Plan (SWMP). The SWMP includes the following key components to achieve water self-sufficiency. Component 1 – Continuing and increasing water conservation efforts to permanently reduce water demand (approximately 3,100 acre-feet per year [AFY] in water demand reduction); Component 2 – Develop sustainable and drought resilient alternative water supplies (approximately 2,860 AFY); Component 3 – Expand local groundwater production within sustainable yield limits (approximately 2,100 AFY). GHD is currently serving as OE focusing on components 2 and 3 for the Olympic Well Field AWTF and Arcadia WTP Expansion project which includes: Upgrade and Expansion of the Arcadia WTP; Restore Olympic Well Field; Construct a new dedicated Olympic Well Field pipeline; Construct a new AWTF for Olympic Well Field flows; and Construct two new Groundwater Injection Wells in the Olympic Well Field.

As OE for this PDB project, GHD is representing the Owner on all technical issues throughout the design process, reviewing all documents pertaining to design and construction, and coordinating other contracts to ensure that all projects operate in a seamless way.



To date, while still very early in the project, GHD has undertaken the following tasks:

- Assisted GMP language and negotiation assistance and PDB contract approach guidance
- Provided durability plan/asset life design criteria
- Analyzing technical viability of incorporating ROTEC and desalitech proprietary systems.
- Engineering assistance to the City's environmental subconsultant for all relevant environmental permits.
- City of CA permit assistance (plant is City of CA, not City of Santa Monica)

We have included additional project experience showing our capabilities in providing detailed design services for drinking water treatment plants. Our thorough understanding of the design and construction phases will greatly benefit the District when providing OE services.

Lenain WTP Master Plan & Expansion

Anaheim, CA

GHD developed a comprehensive Facility Master Plan and detailed design including cost and schedule for the replacement and rehabilitation (R & R) of facilities as well as expansion of the Lenain Water Treatment Plant (LWTP) from 15 to 20 MGD. Planned improvements originally proposed under the Facility Master Plan were designed by GHD and included upgrades related to regulatory compliance, safety and security, water quality, plant reliability and plant expansion. GHD has also established and implemented the Asset Management framework at the LWTP.

Key attributes of the project included:

- North Inlet and Reservoir Structure Manhole and Valve Replacements
- Boat Ramp Rehabilitation
- New Reservoir Outlet Structure Building
- 36-inch CML&C Steel Influent and Effluent Pipeline Improvements
- Bypass Structure Valve Improvements
- Treatment Plant Process Improvements
- Washwater Recovery Facility Improvements
- DDW Involvement



Otay WTP Disinfection Conversion

San Diego, CA

GHD provided detailed design services as part of a Design-Build team with Orion Construction. The project involved the replacement of chlorine gas storage & feed equipment with an on-site Sodium Hypochlorite Generation system. The change from chlorine gas to sodium hypochlorite also requires a modification to the existing Chlorine Dioxide Generator to accommodate the new chemical.

GHD designed the power and instrumentation cabling and power and control interfaces between the existing plant and the various pieces of new equipment as well as piping and mechanical interfaces and complete structural design for accommodating the new tanks and containment areas.

Key attributes of the project included:

- Sodium Hypochlorite Generation system
- Conversion to Liquid Ammonium Sulfate
- Civil, mechanical, structural, electrical and process and instrumentation
- Engineer design of record for the following disciplines
 - Civil, Mechanical, Structural, Electrical, Process, I&C



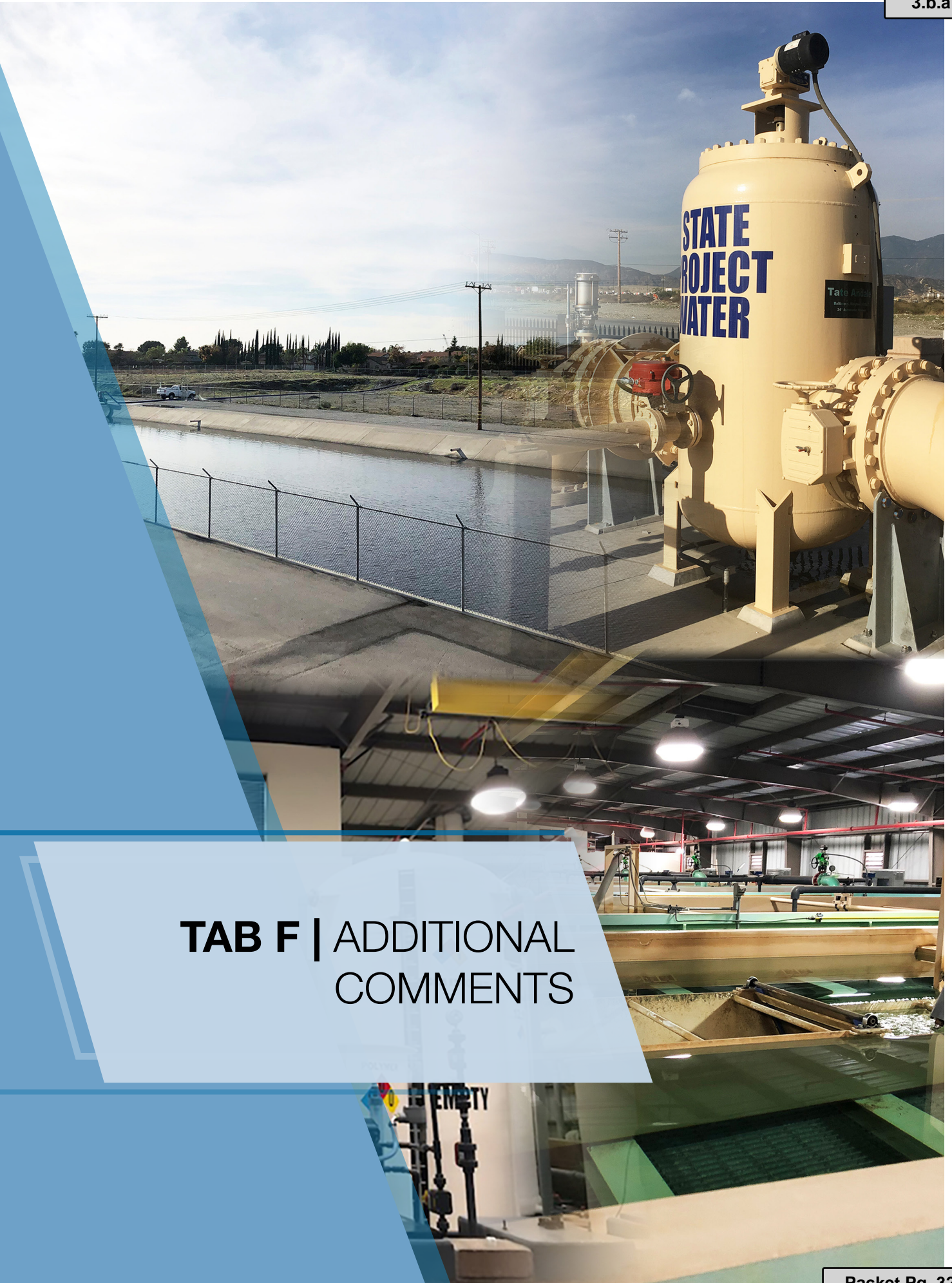

TAB F | ADDITIONAL
COMMENTS

F Additional Comments & Project Approach

This section highlights critical aspects of our team’s approach, based on GHD’s extensive experience with PDB projects and as an OE throughout Southern California. The implementation of this approach is based on the “Top 10 Success Factors” we have learnt from our experience and will significantly streamline the WFF Expansion Project and reduce overall cost.

Progressive Design-Build Top 10 Success Factors

	Owner’s Engineer Involvement	Benefit to the District
1. Close coordination of contract documents	Work with the DB Entity, the District Legal Counsel, and lead Consultants to identify all interface areas, the drivers of those interfaces, and continually monitor progress	Everyone is focused on best for project approach, Minimizes the potential for schedule and cost exceedances
2. Choose the qualified people you want to work with	Fine tune the selection process to ensure the District’s requirements, risks and pain points, are addressed	Use our similar project experience and knowledge of PDB to provide accurate assessments of the DB Entities and refine the selection criteria
3. Consider the approach presented by the potential DB Entity	Review the approaches provided by each DB Entity. Maintain competition among DB Entities for as long as possible	Verification of the DB Entity’s project approach, cost estimate; and its alignment with the District’s goals and requirements
4. Establish process for the Project to promote “spot on” decision-making	Facilitate decision-making meetings to accurately respond to the District’s requirements and establish expansion approach	Validation of decisions by industry leading experts on Blue Ribbon Panel
5. Involve key regulators (DDW) early in the process	Organize and assist in meetings with Stakeholders, including DDW, and use the our Subject Matter Experts including Blue Ribbon Panel	Leverage relationships with DDW and incorporate regulatory constraints early in the design process
6. Senior DB Entity and District Management to Partner to review project status and issues	Raise key issues and track those that impact schedule & cost, determine the resolution process, timeline for resolution, and record progress	Potential issues are resolved early so as to not impact budget, schedule, and / or quality
7. Jointly address permitting issues, track them, and press agencies for action	Identify and track required permits and action items needed to achieve approvals from Regulatory Agencies	Receive permits from Regulatory Agencies in the anticipated timeframe built into the schedule
8. Integrate the District’s goals into the Project Implementation Plan and the Design-Build Entity’s Project Execution Plan	Work with the District and DB Entity to understand, maintain and appropriately address risks in the DBE’s scope and GMP, and monitor continuously	District’s goals and project drivers are met
9. Incentivize the project results you wish to accomplish, e.g. on-time Project Completion	Identify major milestones to meet and results to be achieved by the Design-Build Entity, along with the appropriate incentives	DB Entity is incentivized to in achieving, and hopefully exceeding, the District’s goals
10. Celebrate interim success milestones	Public Outreach notifying the public and arranging events to celebrate project successes	Public sees the Project as a success and builds trust with District

These key success factors have been incorporated our "Roadmap" as shown in the graphic below.



Legend

- Owners Engineer
- Design Builder

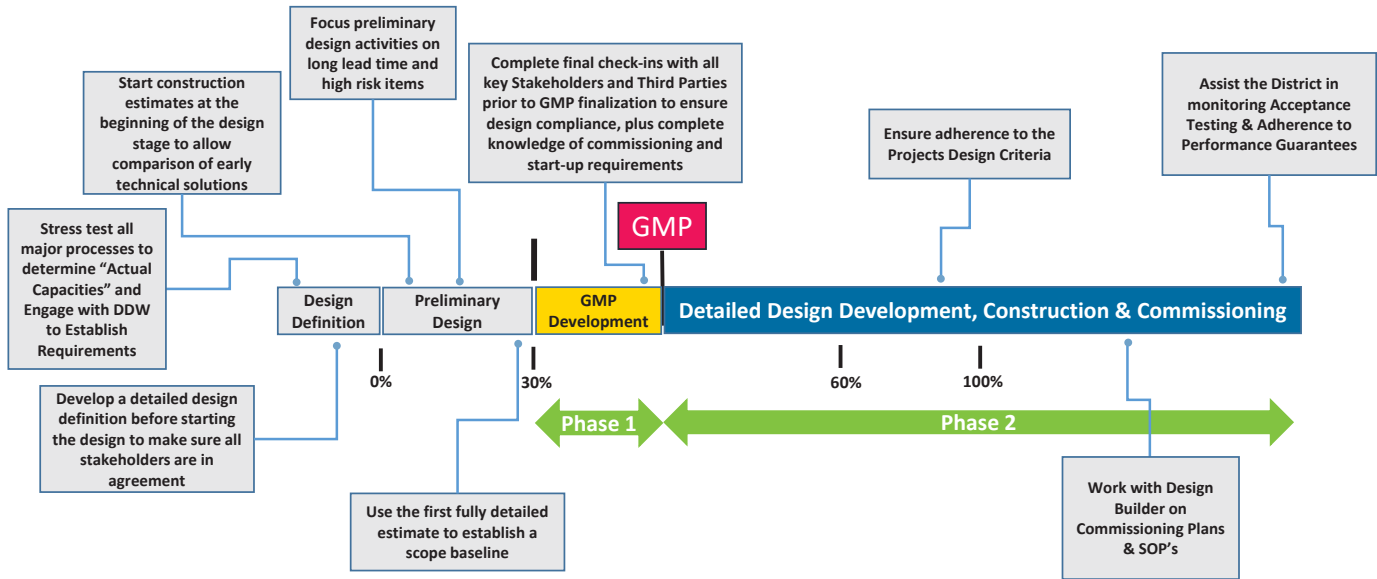

Design Definition

The key to Project success is to make "critical" decisions early on; thus the significance of the Blue Ribbon Panel. The GHD OE team has managed project cost, schedule, and has successfully achieved project outcomes for similar sized water treatment projects in order to meet contract requirements. Our OE team is composed of professionals with the experience to understand and identify potential design, construction, operations and maintenance issues and provide ideas on how to solve or mitigate them. Our experience has always been in fast-paced dynamic environments where time is of the essence and the accurate prediction of construction issues and schedule impacts is critical.

Accurate definitions of expansion approach and process capacities result in achieving significant schedule and cost savings.

Further, we have already had several discussions with equipment vendors to establish expansion concepts and validated these discussions with DDW. These efforts have been undertaken to demonstrate our technical creativity, key understanding of the Project, and commitment to the District and are presented in below and on the following graphic.

Stress Test Existing Processes to Establish Actual Capacity

The Oliver P. Roemer Water Filtration Facility has significant reliability and redundancy features that with further evaluation can lead to opportunities for significant cost savings and improved reliability. GHD's approach includes creative ideas for consideration to capitalize on some of these features.

Stress test the Preliminary Treatment to establish hydraulic and process capacities.

These redundancy and reliability features are unmatched by any plants treating State Project Water and offer the District significant advantages in delivering this 16 MGD expansion. In addition, there is extra capacity in the Preliminary Treatment and yard piping in preparation for the 6 MGD plant expansion that was not implemented.

The Preliminary Treatments indicates a current extra capacity of 7.2 MGD, constructed in anticipation of the previously mentioned 6 MGD expansion. Running the three parallel treatment trains at higher than their design capacity of 21.6 MGD would be critical to establish the extent of needed infrastructure. **It is expected that operating at flows greater than 21.6 MGD would have a minimal impact on total organic carbon (TOC) removal and results in an increase in settled water turbidity.** Establishing these performance values at flows up to 30.4 MGD allows for very efficient expansion of the Oliver P. Roemer Water Filtration Facility.

Evaluate Multiple Expansion Alternatives based on Cost, Reliability, and meeting Regulatory Requirements

Conceptual designs for both the Trident process and Microfiltration/ Ultrafiltration (MF/UF) for a 16 MGD plant expansion are provided below and illustrated in the following graphic:

1. **Replacing existing Trojan UV reactors with new more efficient models.** The existing reactors represent first generation equipment with significant spare parts and efficiency issues. **In fact, the existing Trojan UV SWIFT 6L24 reactors can be replaced by the new 4L24 reactors that has the same physical dimensions and achieve the 30.4 MGD target treatment capacity.** This would be a very cost-effective approach for expanding the UV disinfection facility from both capital and O&M perspectives. Preliminary design drawings for the Trojan UV reactor replacements are attached at the end of this section for your reference.

We have confirmed this creative upgrade of the UV process with Trojan and received a conceptual bid for the new equipment.

2. **Operate the GAC filtration adsorbers in parallel mode.** Based on information provided by Plant Operations during the tour on December 11, 2019, the GAC replacement frequency is considerably low, which easily allows for a change from in series to in parallel mode operation without reducing process efficiency. This would double their capacity, without any additional capital investment.

We have discussed this option with DDW and they were receptive with that approach.

Base on equipment alone, using MF/UF instead of continuing with the Trident packaged system, would be almost 3 times the cost (\$10M versus \$3.5M).

Pilot and Demonstration Testing

Our team has significant pilot and demonstration testing experience in support of regulatory discussions with DDW to establishing process capacity as the case for the Preliminary Treatment process at the Oliver P. Roemer Water Filtration Facility. **Our team has also conducted many demonstration testing for DDW to allow higher filtration rates than the 6 gpm/sf granted for conventional filters.** This experience benefit the District in establishing the regulatory discussion early on with the DDW to focus the preliminary design activities based on an approved process testing protocol. **Further, looking specifically at the members of the Blue Ribbon Panel, no other team in southern California can come close to matching the pilot and demonstration testing experience that exists on this Panel.**

30 Percent Design Package

GHD proposes to employ a proven design development process with effective control methods that:

1. Leads to early Project clarity and definition of District’s critical needs while ensuring the right balance between CAPEX or OPEX (i.e., lowest life-cycle cost for the Project);
2. Does not shift additional risk to the District.

It is critical that these potential impacts are quantified and discussed during the design development process as opposed to during the detailed design.

The level of detail required for a 30% PDB Design package is not an industry standard.

Work Element	30 Percent Level
Design Information	
Equipment Sizing Calculations	For Major Equipment Only
Proposed Equipment Suppliers	For Major Equipment Only
Geotechnical Baseline Report	Complete
Potholing Results	Draft
Fire Protection Report	Illustrative
Asset List (Retired and New)	Complete
Shop Drawings Submittal List, for preselected equipment	Complete
Arc Flash	Draft
Facility O&M	
Operating Philosophies	Draft
O&M Staffing Requirements	Illustrative
SCADA Graphic Screens	Illustrative
Electrical	
Electrical System Analysis Report	Illustrative
Lighting Calculations	Illustrative
Cable Pulling Tension Calculation	Not Required
Duct bank cable derating and cable fill calculations	Not Required
Conduit Schedule	Not Required
Quantify and determine electrical area classification for the basis of design	Illustrative
Electrical Load Criticality Ranking Table	Illustrative
Load List	Illustrative
Electrical Master Plan Concept Report Update	Draft
Standby Generator Sizing Calculations	Complete

Existing WFF Redundancy and Reliability

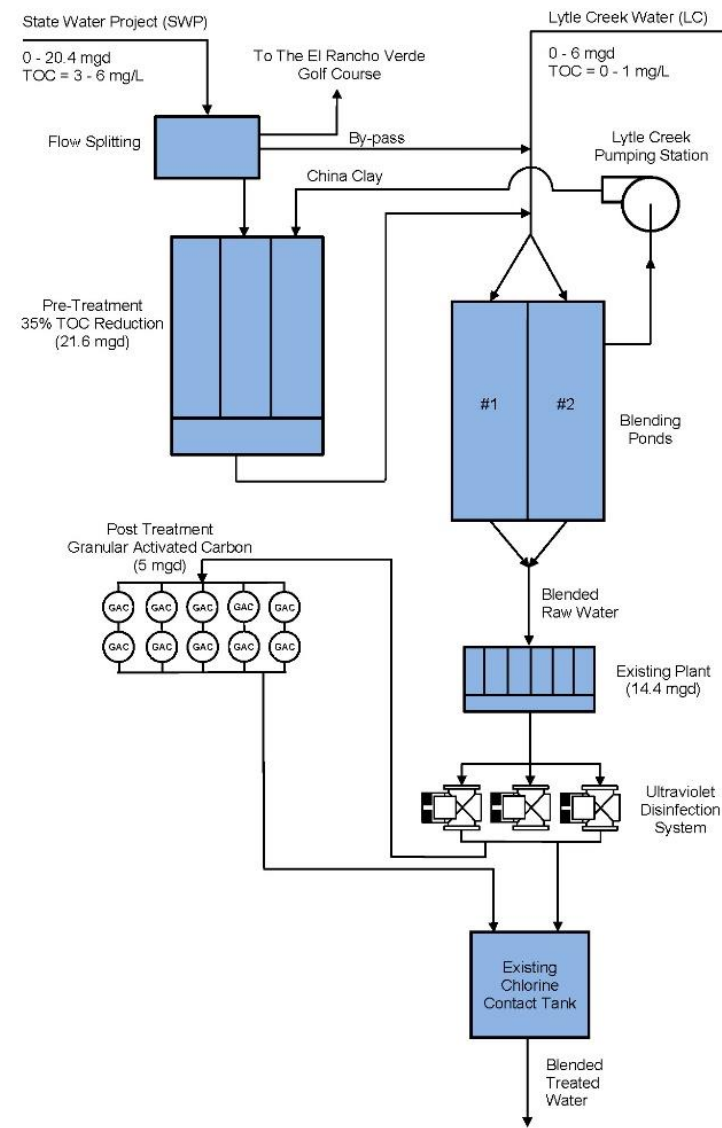

- Dual coagulation/flocculation/sedimentation for State Project Water
- Multi-barrier disinfection processes with UV (most effective for Cryptosporidium and Giardia) and chlorine (most effective for virus)
- GAC filtration in series of up to 1/3 of treated water for additional TOC removal
- Blending ponds of source waters to further optimize treatment
- Significant excess capacity of filter backwash recovery and solids handling
- Availability of significant areas within the fence for any expansions/modifications

Capacity Expansion with Trident System

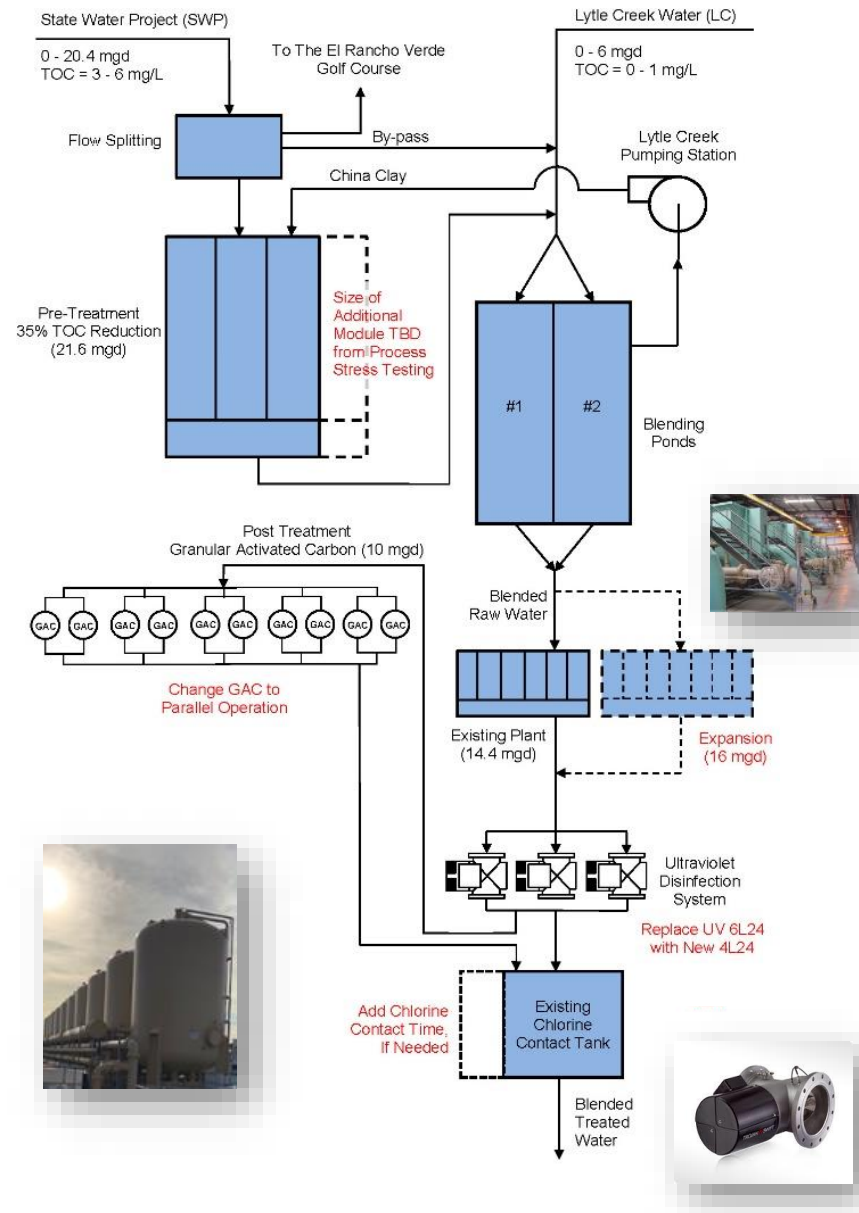

- Add 7 Trident Package Treatment Systems Replacing existing Trojan UV reactors with new more efficient models.
- Operate GAC Adsorbers in Parallel Mode
- Stress Test the Preliminary Treatment to establish Hydraulic and process capacities

Capacity Expansion with MF/UF Membranes

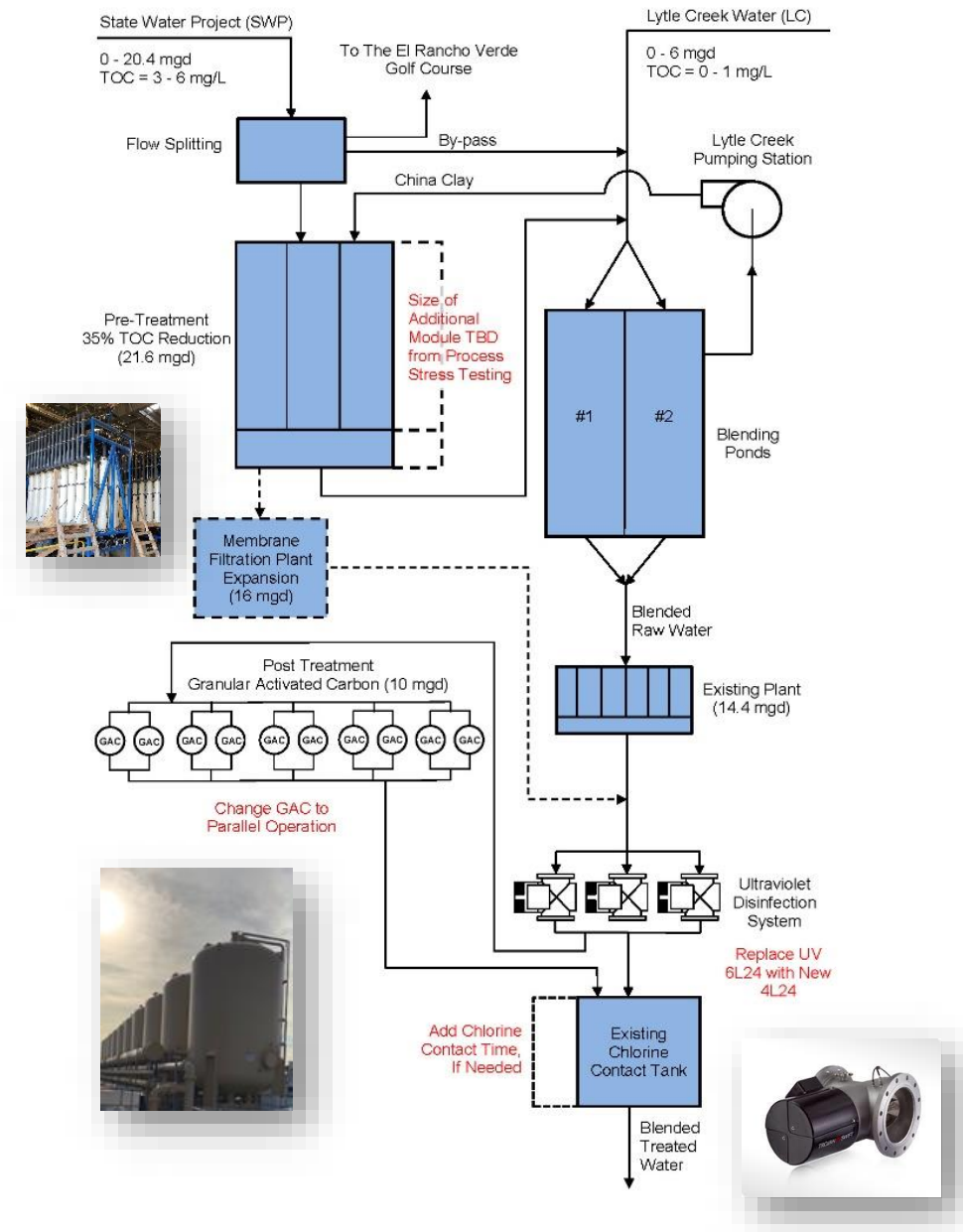

- Add 6 MGD of MF/UF treatment capacity
- Replace existing UV reactors with new more efficient models
- Operate GAC adsorbers in parallel mode
- Stress test the Preliminary Treatment to establish hydraulic and process capacities.

Too much detail may be overly prescriptive while not enough may not provide a clear understanding of the project goals and objectives. Our OE Project Manager, Jamal Awad, has managed several Design-Build projects and will develop specific project expectations leading to better definitions for deliverables, focused reviews, and successful projects. Jamal recently completed WRD's successful \$115M GRIP PDB project and will bring the same approach for the Oliver P. Roemer Water Filtration Facility expansion.

GHD has established, documented, implemented, and maintained a Quality System for its North American operations in accordance with ISO 9001:2015 under the ANAB accreditation system. As part of this, key documents that GHD maintains are the Quality System Overview, Quality System Procedures Manual and Quality Work Instructions.

DB Entity Selection and Contract Negotiation

GHD has prepared the contractual documents required for selecting the DB Entity. The following highlights examples of matters to consider during contract negotiation with the DB Entity.

Shared Savings clauses work extremely well. We have found that sharing cost savings, which may be available when final contract costs fall below the GMP, with the DB Entity is an outstanding motivator for most contractors to come up with smart ideas and deliver projects on time. As the OE, GHD will develop a shared savings program that sets up a "win-win" situation for both the District and the DBE.

The Southern California labor market is extremely tight. The availability of competent tradespeople is a major challenge in this robust construction market. A tight labor market is a risk that has potential negative impacts on costs, schedule, quality, and safety. In such markets, GHD has learned that constructability of the design and labor availability are the key elements in resolving this risk. A careful pre-qualification process will help identify those firms and their potential subcontractors who have sufficiently available tradespeople to meet the schedule KPIs for the project at reasonable cost.

GMP

Requiring a Guaranteed Maximum Price (GMP) in PDB projects brings inherent risks associated with design development and the unknowns. As the OE, GHD will provide its technical expertise and project management experience to minimize the differences in scope and price, and manage this risk so that District financial, schedule, and performance expectations are maintained.

DB Design Packages

The announced percentage of completion by the designer is generally less than actual. We have learned that when the DB Entity declares that a particular design has reached an overall percentage of completion, in most cases, the electrical and instrumentation and control design lags far behind the declared percentage completion of the overall design. As the OE, GHD will monitor design progress to ensure that all elements of the design are at their target completion to avoid expensive rework.

Constructability

Constructability reviews, if done at all, are completed too late in the design process. This often, neglected, or failed process is a missed opportunity and causes the loss of the substantial benefits derived from a rigorous constructability review process. As the OE, the GHD team will provide experienced construction managers to monitor the design process to synergize with the design development.

Contract language such as "reasonably inferred" to cover the inevitable gaps in the design that exists when asking for pricing before 100% design does not work. As OE, GHD's approach would be to identify significant design gaps and define them.

Operations Involvement

Plant operations input during design development is not as effective as it may appear. While these efforts are well-intentioned and begin with great gusto, most often the pressure of time on both the design and operations teams cause this process to break down, and momentum is lost and rarely regained. We have also found that many plant operators, while expert in the successful operation of their respective treatment facilities, have limited time and knowledge sometimes required to effectively and efficiently review engineering drawings, standards, and specifications. The use of advanced technology such as BIM can be useful to develop project drawings, and other graphics to ensure that the operator's input is based on more than just contract drawings. This process, further enhanced by facilitated workshops or review sessions led by the OE team's operations specialists using HAZOP approach has been proven to be an effective method of soliciting operator input.

"Ready to Move" means the GHD Team has commenced on some preliminary items to start work today

Our core team members have made a commitment to dedicate themselves to the Oliver P. Roemer Water Filtration Facility expansion.

Further, to enable our project team to meet the District's expectations with respect to staff skills, resources and schedule, a Rapid Start Binder will be delivered to the District 15 & 30 days after project award. This will include, as a minimum, the following:

- **Environmental Documentation and Permitting:** Reviews and next steps
- **DDW Engagement:** Development of Agenda and Project Initiation meeting
- **Existing Process Evaluation:** List of opportunities
- **Project Risk Register:** Detailed list of Preliminary Risks, Risk Factor, and Risk Allocation
- **Permit Matrix:** All-encompassing list for the entire project
- **GMP Development Work:** Schedule and Deliverables outline
- **Document Control:** Outline of Protocols and Filing Structure
- **Project Schedule:** Draft Schedule, incorporating Key Milestones from Contracts 1 & 2
- **DB Entity Evaluation:** Templates and Criteria related to the Selection Process
- **Monthly Report:** Template of outline and content

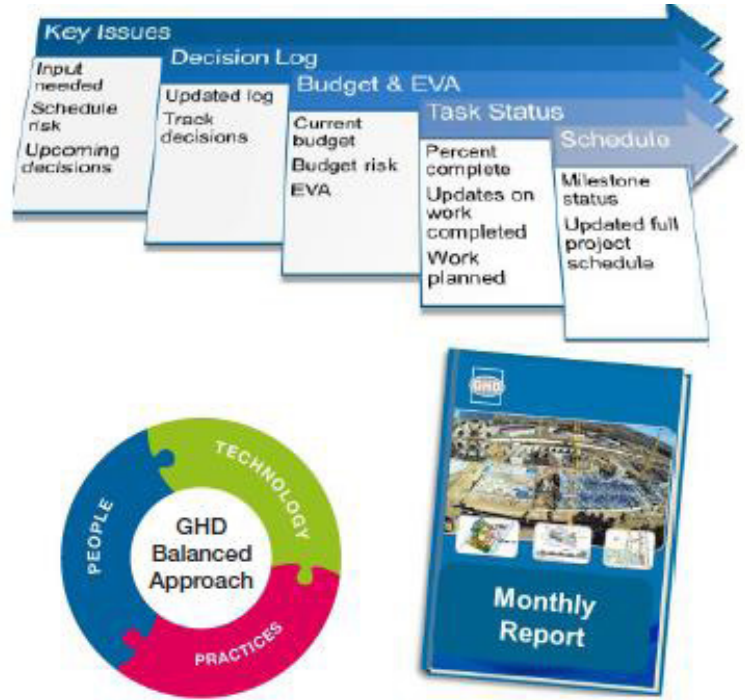

Rapid Start Schedule* – “The First 30 Days”

	Environmental Doc's & Permitting	DDW Work	Existing Process Evaluation	Risk Register	Permit Matrix	GMP Development Work	Document Control	Project Schedule	DB Entity Evaluation	Monthly Report
0 - 15 Days	Reviews and Next Steps	Develop Agenda for Project Meeting with DDW	Perform Baseline Capacity Evaluation	Detailed List of Preliminary Risks, Risk Factor, Risk Allocation	All Encompassing List for Entire Project	Schedule & Deliverables Outline	Outline of Protocols & Filing Structure	Draft Schedule incorporating Key Milestones from Contracts 1 & 2	Templates & Criteria Related to the Selection Process	Template of Outline and Content
15-30 Days	Kick-off Meeting with City's Environmental Consultant	Meet with DDW	Develop Physical Stress Testing Protocol for Specific Processes	Risk Workshop with City	Fully Loaded Document outlining Permit Req, Responsible Party, etc...	Project Specific Templates of Associated Deliverables	Implementation & Demonstration of Document Control Tools & Processes	Development of Other Schedule Tracking Tools Suitable for PDB Projects	Detailed Schedule of DB Entity Selection Period Process	Finalized Version Incorporating All of the City's Requirements

*Components of this will be incorporated into the Project Implementation Plan (PMP) with a Draft completed within 90 days after NTP

TROJAN UV SWIFT™

EQUIPMENT INTERCONNECTIONS

No.	DESCRIPTION	FROM	TO
1	CONTROL POWER PANEL (CPP) POWER SUPPLY 480VAC, 3 PHASE, 3 WIRE + GROUND (MUST BE FED FROM 3PH GROUNDED WYE SUPPLY OR TRANSFORMER) 42.5 KVA BALANCED LOAD MAX 53 AMPS PER PHASE	DISTRIBUTION PANEL (DP) (BY OTHERS) (NOT SHOWN)	CPP (TOP OR BOTTOM OF PANEL) MUST BE SPECIFIED BY CUSTOMER
2	UV CHAMBER POWER SUPPLY (HV CONDUIT) MINIMUM 12AWG, 10KV XLPE INSULATION (COLOR BLACK) (1 PER LAMP) MINIMUM 12AWG, 10KV XLPE INSULATION (COLOR WHITE) (1 PER LAMP) + GROUND (MINIMUM 8/19 AWG) (CABLING PROVIDED BY TROJAN)	CPP (BOTTOM OF PANEL ONLY)	UV CHAMBER JUNCTION BOX
3	UV CHAMBER CONTROLS (LV CONDUIT) UV SENSOR: 22AWG x 10 CORE + GROUND SHIELD CABLE WITH DRAIN WIPER MOTOR: 16AWG x 2 CORE + GROUND SHIELDED CABLE WITH DRAIN CONTROL SIGNALS: 16AWG x 11 WIRE + GROUND	CPP	UV CHAMBER JUNCTION BOX
4	DISCRETE UV SYSTEM STATUS INFORMATION SYSTEM ON/OFF STATUS - 2 CONDUCTORS SYSTEM READY STATUS - 2 CONDUCTORS COMMON CRITICAL ALARM - 2 CONDUCTORS COMMON MAJOR ALARM - 2 CONDUCTORS COMMON MINOR ALARM - 2 CONDUCTORS REMOTE ON/OFF CONTROL - 2 CONDUCTORS	CPP	PLANT PLC (BY OTHERS) (NOT SHOWN)
5	FLOW METER ANALOG INPUT (VIA ETHERNET) (BY OTHERS)	PLANT SCADA (BY OTHERS) (NOT SHOWN)	CPP
6	UV INTENSITY ANALOG OUTPUT (VIA ETHERNET)	CPP	PLANT SCADA (BY OTHERS) (NOT SHOWN)
7	ETHERNET/IP COMMUNICATION SHIELDED CAT5E CABLE CONNECTORS RJ45	CPP	PLANT SCADA (BY OTHERS) (NOT SHOWN)
8	DISCRETE INLET VALVE OPEN CONTROL OUTPUT - 2 CONDUCTORS DISCRETE INLET VALVE CLOSE CONTROL OUTPUT - 2 CONDUCTORS DISCRETE INLET VALVE OPEN STATUS INPUT - 2 CONDUCTORS DISCRETE INLET VALVE CLOSE STATUS INPUT - 2 CONDUCTORS DISCRETE INLET VALVE LOCAL/REMOTE MODE INPUT - 2 CONDUCTORS	CPP CPP CPP CPP CPP	INLET VALVE (BY OTHERS) INLET VALVE (BY OTHERS) CPP CPP CPP
9	DISCRETE OUTLET VALVE OPEN CONTROL OUTPUT - 2 CONDUCTORS DISCRETE OUTLET VALVE CLOSE CONTROL OUTPUT - 2 CONDUCTORS DISCRETE OUTLET VALVE OPEN STATUS INPUT - 2 CONDUCTORS DISCRETE OUTLET VALVE CLOSE STATUS INPUT - 2 CONDUCTORS DISCRETE OUTLET VALVE LOCAL/REMOTE MODE INPUT - 2 CONDUCTORS	CPP CPP CPP CPP CPP	OUTLET VALVE (BY OTHERS) OUTLET VALVE (BY OTHERS) CPP CPP CPP
10	OPTVIEW™ 4-20mA ANALOG INPUT	OPTVIEW™ (BY OTHERS) (NOT SHOWN)	CPP (TOP OF PANEL)
11	OPTVIEW™ POWER SUPPLY 120V, 1 PHASE, 2 WIRE+ GROUND, 0.1 kVA, 0.8 AMPS	DP (BY OTHERS) (NOT SHOWN)	OPTVIEW™ (BY OTHERS)
12	WATER SUPPLY TO OPTVIEW™ (INLET) (SEE SPECS ON UNIT FOR REQUIRED FLOW RATE AND LINE SIZE)	DP (BY OTHERS) (NOT SHOWN)	OPTVIEW™ INLET (BY OTHERS)
13	OPTVIEW™ TO DRAIN (OUTLET) (SEE SPECS ON UNIT FOR REQUIRED DRAIN SIZE)	OPTVIEW™ (BY OTHERS) (NOT SHOWN)	DP (BY OTHERS) (NOT SHOWN)
14	UV TRANSMITTANCE METER ALARM DISCRETE INPUT	OPTVIEW™ (BY OTHERS) (NOT SHOWN)	PLANT SCADA (BY OTHERS) (NOT SHOWN)

NOTES:

- : ANCHOR BOLTS ARE NOT SUPPLIED BY TROJAN TECHNOLOGIES.
- : SYSTEM CONDUIT, WIRING, DISTRIBUTION PANELS & INTERCONNECTIONS BY OTHERS.
- : ELECTRICAL REQUIREMENTS SHOWN ARE TO SUPPLY TROJAN UV EQUIPMENT ONLY. ELECTRICAL INRUSH FACTOR TO BE ADDED AS PER LOCAL CODE.
- : CONTRACTOR TO REVIEW ALL TROJAN TECHNOLOGIES INSTALLATION INSTRUCTIONS PRIOR TO EQUIPMENT INSTALLATION.

UV CHAMBER NOTES:

1. CHAMBER MATERIAL TO BE TYPE 316L STAINLESS STEEL.
2. MAXIMUM OPERATING PRESSURE TO BE 150 PSI.
3. TROJAN RECOMMENDS THAT VALVES ARE USED TO ISOLATE THE UV CHAMBER FROM PLANT FLOW FOR SERVICING. ALL VALVES ARE TO BE SUPPLIED BY OTHERS.
4. FLOW CONDITIONER MUST BE IN PLACE BEFORE INSTALLING UV CHAMBER INTO PIPE. SEE INSTALLATION INSTRUCTIONS FOR CORRECT ORIENTATION.
5. UV CHAMBER WEIGHT = DRY 1500lbs WET 2240lbs

CONTROL POWER PANEL (CPP) NOTES:

1. CONTROL POWER PANEL TO BE E-COAT POWDER COATED RAL7035 (LIGHT GREY) OR SIMILAR. MATERIAL IS TO BE MILD STEEL, NEMA 12, VENTILATED AND PANEL IS TO BE FLOOR MOUNTED
2. CONDUIT TO BE SUPPLIED BY OTHERS. ALL CONDUIT TO BE RIGID, METAL FLEX CONDUIT OR EQUIVALENT ACCORDING TO LOCAL CODE.
3. CABLING DISTANCE BETWEEN CONTROL POWER PANEL AND UV CHAMBER SHALL BE NO GREATER THAN 72'.
4. PANEL WEIGHT = 1353lbs

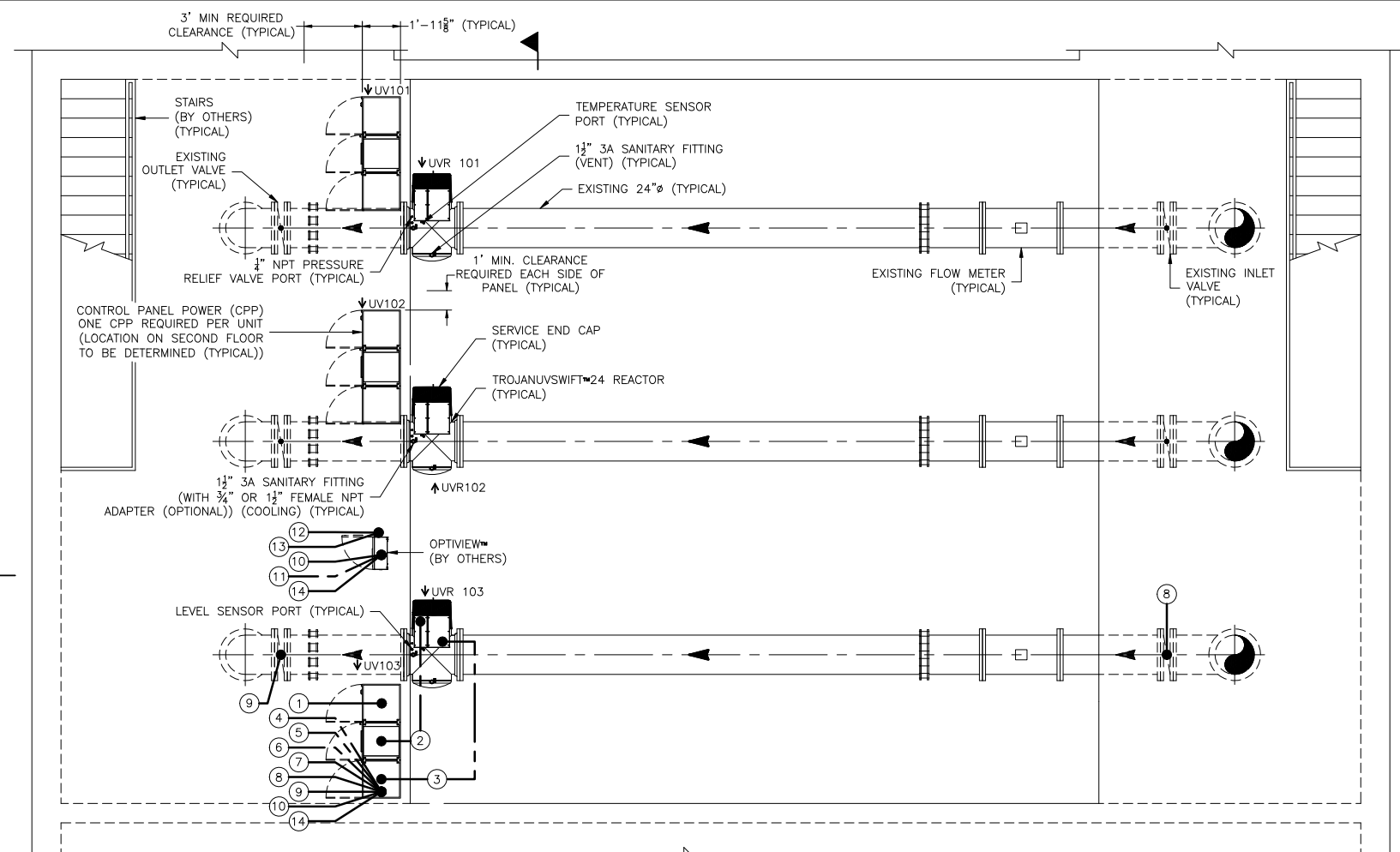

PLAN VIEW
SCALE: AS SHOWN
NOTE: INTERCONNECTS SHOWN FOR ONE (1) TRAIN ARE TYPICAL FOR ALL

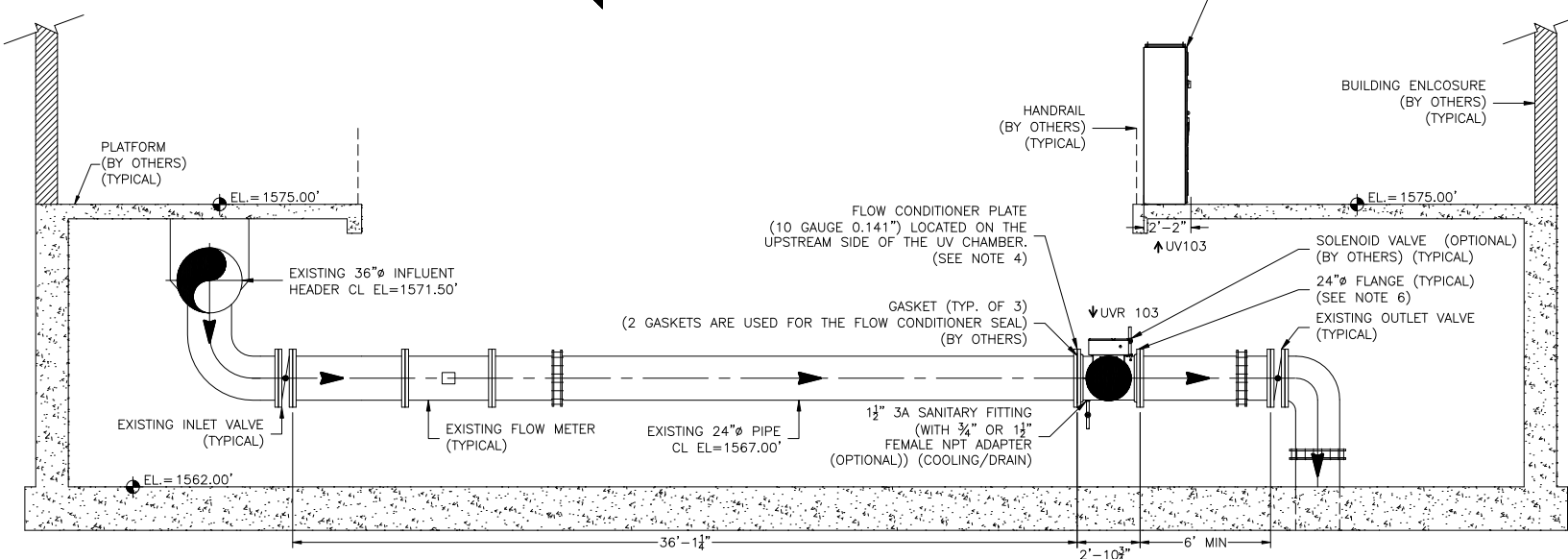

A SECTION
SCALE: AS SHOWN

PRELIMINARY, NOT FOR CONSTRUCTION
VERIFY DIMENSIONS BEFORE COMMENCING CIVIL OR DESIGN WORK

DESIGN CRITERIA	PEAK FLOW	30.40 MGD
TARGET CONTAMINANTS	3- LOG CRPTOSPORIDIUM	
HEADLOSS	3.5"	
U.V. TRANSMITTANCE	89%	

TROJAN UV
CONFIDENTIALITY NOTICE
Copyright © 2020 by Trojan Technologies. All rights reserved. No part of this document may be reproduced, stored in a retrieval system, or transmitted in any form, without the written permission of Trojan Technologies.

DESCRIPTION:		QUOTE NO.
LAYOUT, TROJANUVSWIFT WEST VALLEY WATER DISTRICT REPLACEMENT CA		222946
DRAWN BY : MJU	DATE : 20JA15	PROJECT NO. N/A
CHECKED BY : MC	DATE : 20JA20	DWG NO. S01
APPROVED BY : NDB	DATE : 20JA20	REV. A
SCALE (11x17) : 1/8"=1'-0"		LOG NUMBER : N/A

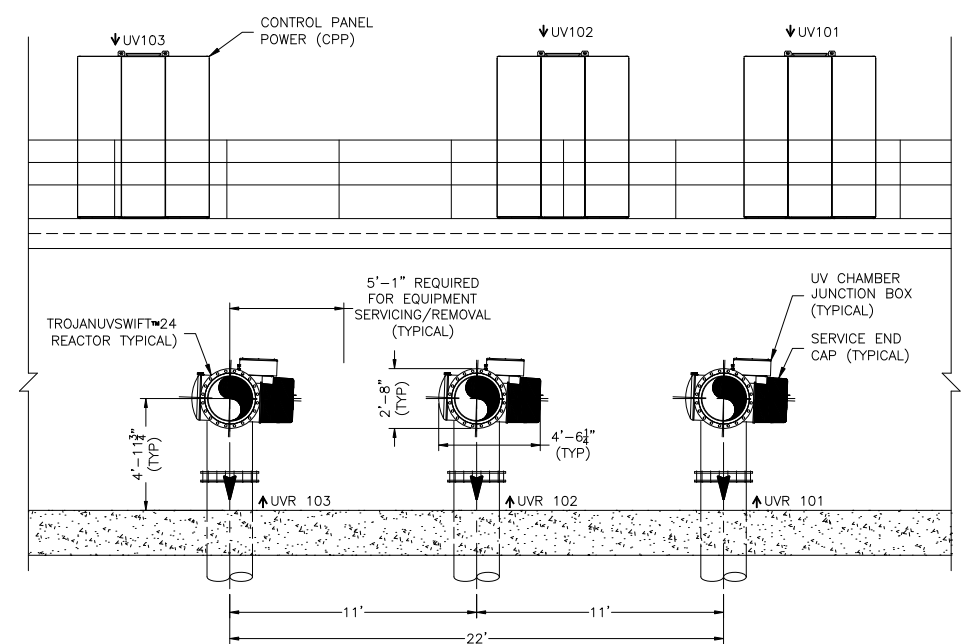

B SECTION
 SQ1/S02 AS SHOWN
 NOTE: STAIRS NOT SHOWN FOR CLARITY.

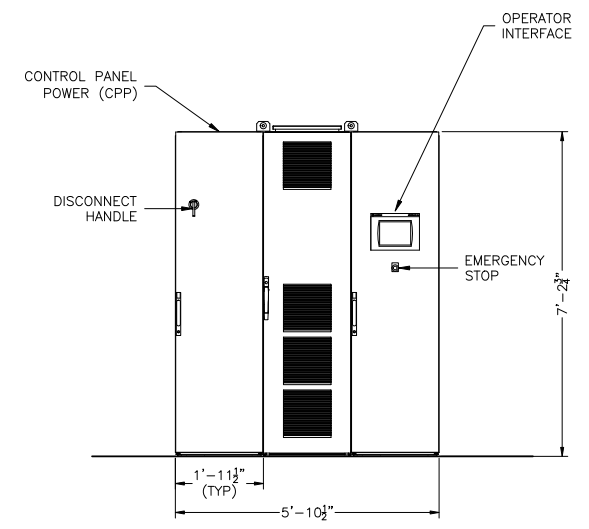

FRONT VIEW OF CPP
 SCALE: NOT TO SCALE

CONTROL POWER PANEL (CPP) NOTES:

1. CONTROL POWER PANEL TO BE E-COAT POWDER COATED RAL7035 (LIGHT GREY) OR SIMILAR. MATERIAL IS TO BE MILD STEEL, NEMA 12, VENTILATED AND PANEL IS TO BE FLOOR MOUNTED
2. CONDUIT TO BE SUPPLIED BY OTHERS. ALL CONDUIT TO BE RIGID, METAL FLEX CONDUIT OR EQUIVALENT ACCORDING TO LOCAL CODE.
3. CABLING DISTANCE BETWEEN CONTROL POWER PANEL AND UV CHAMBER SHALL BE NO GREATER THAN 72'.
4. PANEL WEIGHT = 1353lbs

UV CHAMBER NOTES:

1. CHAMBER MATERIAL TO BE TYPE 316L STAINLESS STEEL.
2. MAXIMUM OPERATING PRESSURE TO BE 150 PSI.
3. TROJAN RECOMMENDS THAT VALVES ARE USED TO ISOLATE THE UV CHAMBER FROM PLANT FLOW FOR SERVICING. ALL VALVES ARE TO BE SUPPLIED BY OTHERS.
4. FLOW CONDITIONER MUST BE IN PLACE BEFORE INSTALLING UV CHAMBER INTO PIPE. SEE INSTALLATION INSTRUCTIONS FOR CORRECT ORIENTATION.
5. UV CHAMBER WEIGHT = DRY 1500lbs WET 2240lbs

NOTES:

- : ANCHOR BOLTS ARE NOT SUPPLIED BY TROJAN TECHNOLOGIES.
- : SYSTEM CONDUIT, WIRING, DISTRIBUTION PANELS & INTERCONNECTIONS BY OTHERS.
- : ELECTRICAL REQUIREMENTS SHOWN ARE TO SUPPLY TROJAN UV EQUIPMENT ONLY. ELECTRICAL INRUSH FACTOR TO BE ADDED AS PER LOCAL CODE.
- : CONTRACTOR TO REVIEW ALL TROJAN TECHNOLOGIES INSTALLATION INSTRUCTIONS PRIOR TO EQUIPMENT INSTALLATION.

 CONFIDENTIALITY NOTICE Copyright © 2020 by Trojan Technologies. All rights reserved. No part of this document may be reproduced, stored in a retrieval system, or transmitted in any form, without the written permission of Trojan Technologies.	DESCRIPTION: LAYOUT, TROJANUVSWIFT WEST VALLEY WATER DISTRICT REPLACEMENT CA		QUOTE NO. 222946
	DRAWN BY : MJU	DATE : 20JA15	PROJECT NO. N/A
	CHECKED BY : MC	DATE : 20JA20	DWG NO. S02
	APPROVED BY : NDB	DATE : 20JA20	REV. A
	SCALE (11x17) : 1/8"=1'-0"	LOG NUMBER : N/A	



TABS G, H, & I
TAB G | CONFLICT OF INTEREST
TAB H | OTHER INFORMATION
TAB I | WWD STANDARD AGREEMENT
FOR PROFESSIONAL SERVICES

G Conflict of Interest

We hereby acknowledge that GHD, individuals employed by the GHD, or firms employed by or associated with GHD, including subconsultants/subcontractors, do not have a conflict of interest with the WFF Expansion Project.

H Other Information

Insurance Requirements

GHD acknowledges that we will meet the insurance requirements per Section 14 of the District's standard Agreement for Professional Services (PSA).

Litigation

GHD trusts the District will appreciate that due to the commercial sensitivity and confidentiality of any litigation in which GHD may be presently involved, GHD is not at liberty to disclose the information sought. However, we point out that as a component of its prudent risk management practices, GHD obtains high quality professional liability insurance in the world market, and domestically in the U.S., to provide cover in the industries in which it operates. As a consequence of engaging in business, there are sometimes claims asserted which may or may not give rise to litigation. The details and progress of any such claims are by necessity commercially sensitive and remain in confidence. We are able to inform you that there have been claims notified in the normal course of business, none of which we believe are material to the services which are the subject the WFF Expansion Project. There are however presently no significant ongoing contract failures, no criminal matters, and there have been no judgments against GHD Inc. within the last 5 years.

Contract Default

GHD has not defaulted on any professional contract.

Q&A's and Addenda

GHD hereby acknowledges the Questions & Answers posted to the PlanteBid site. We also acknowledge that no Addenda were released as part of this procurement.

I Standard Agreement for Professional Services

GHD hereby accepts all the terms and conditions specified in the standard PSA.

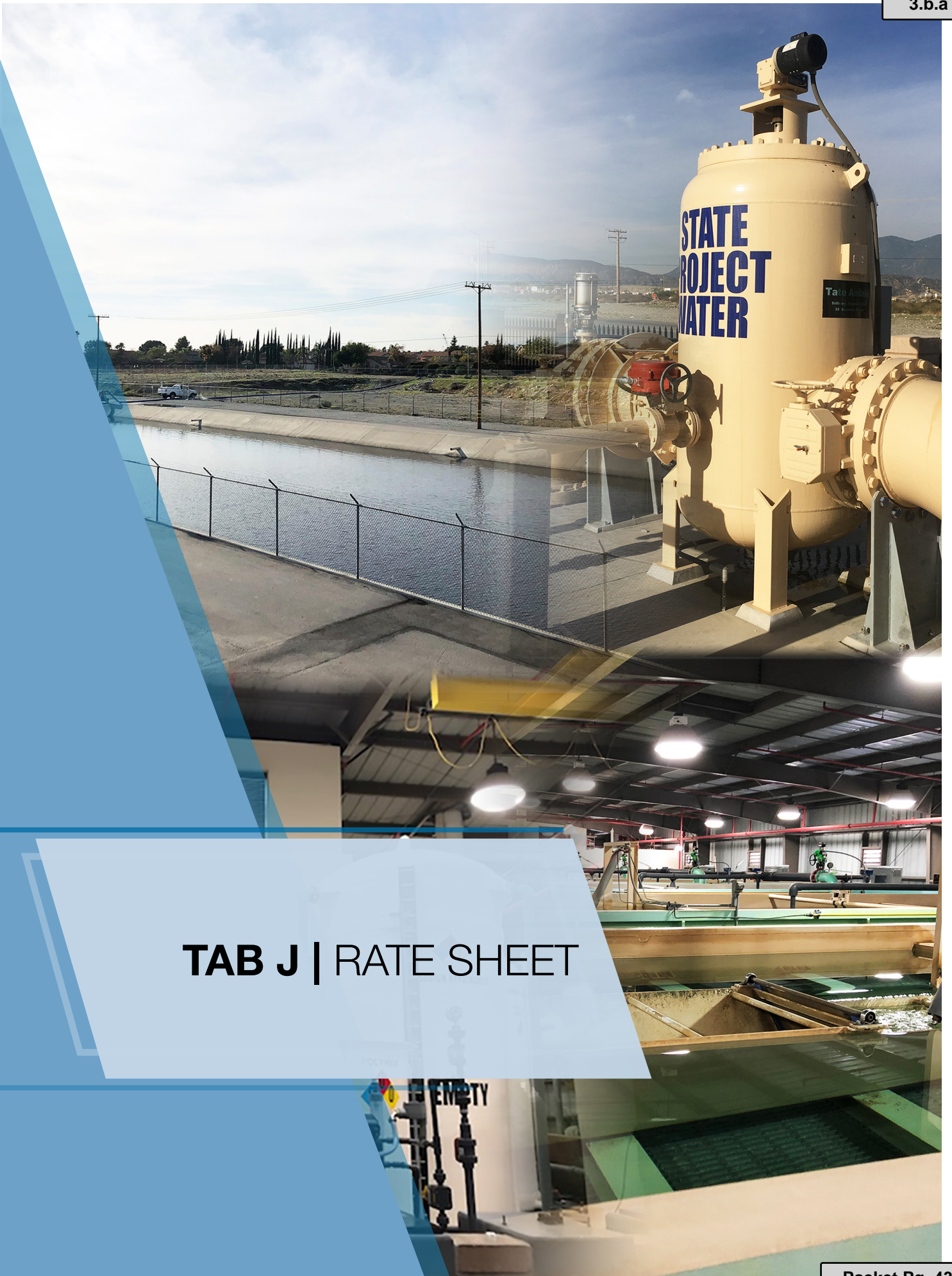

TAB J | RATE SHEET

HOURLY RATE SCHEDULE

Effective through June 30, 2023

GHD PERSONNEL	\$/Hour
Duncan Findlay, JD - Legal	\$290.00
Chris Hertle, MPhil - Blue Ribbon Panel Chair	\$280.00
Matt Winkelman, PE - Digital.....	\$280.00
Paul Hermann, CPEng - Design-Build Services Lead	\$280.00
Roop Lutchman, PEng, PMP - Asset Management	\$280.00
Hector Ruiz, PE - Project Advisor	\$270.00
Homayoun (Omar) Moghaddam, PE, CPP - Permitting/Regulatory Compliance.....	\$270.00
Jamal Awad, PhD, PE - Project Manager	\$270.00
Mike Chapman - Blue Ribbon Panel/Conventional Treatment.....	\$270.00
Sridhar (Sri) Sadasivan, PE, SE - Design-Build Contract Documents.....	\$270.00
Erel Betser, PE - Fire Protection	\$250.00
Andrew Peek - Durability/Corrosion	\$250.00
Jeff Knauer, PE, ME, NACE CP Specialist - Corrosion/Material	\$250.00
John McLaughlin, PE - Security	\$250.00
Kevin Tirado, PE - Constructability Review.....	\$250.00
Mark Donovan, PE - Treatment Evaluation & 30% Design Documentation Process Lead	\$250.00
Ulysses Fandino, PE - Plant Piping	\$250.00
Larry Tortuya, PE - Stormwater.....	\$230.00
Mark Waer, PhD - Treatment Evaluation Process & GAC/Construction Observation Process Support	\$230.00
Casey Raines, PE - Pipeline/Infrastructure	\$220.00
Francisco Andrade, PE - Structural.....	\$220.00
Mehdi Mardi, PE - Electrical and I&C.....	\$220.00
Chris Richards, PE - Telemetry.....	\$210.00
James Taylor - Safety/HIS.....	\$190.00
Mike Fried - Cost Estimating.....	\$190.00
Nathan Towleron, PE, QSD/QSP - WQ Management Plan	\$190.00
Nick Alvaro - Drone Survey	\$180.00
Jonathan Linkus, AICP, LEED AP - LEED.....	\$170.00
Ryan Kristensen - Resident Engineer Mechanical.....	\$170.00
Leila Munla, PhD - Membranes/Pilot Testing	\$165.00
Devin Brady - CAD/BIMM.....	\$145.00

SUBCONSULTANTS

R. Rhodes Trussell (Trussell Technologies, Inc.) - Blue Ribbon Panel	\$345.00
James Borchardt (Stantec) - Blue Ribbon Panel	\$325.00
Bill Bellamy (Bellamy and Sons, LLC) - Blue Ribbon Panel	\$250.00
Charles Cruz, PE (SPI) - Membranes	\$260.00
Jim Vickers, PE (SPI) - Blue Ribbon Panel	\$260.00
Emily Owens-Bennett, PE, BCEE - Permitting/Regulatory Compliance - DDW Coordination	\$230.00
John Kennedy, PE - Process Capacity Demonstration Testing/Pilot Testing.....	\$230.00
Hashmi Quazi, PhD, GE (Converse Consultants) - Geotechnical	\$220.00
Jason Mate (MNS) – Resident Engineer.....	\$200.00
Samir Hijazi (ARCHISSANCE) – Architectural	\$185.00
Kirill Dolinskiy, PMP (KRD Management Consulting, LLC).....	\$182.00
Ed Macias (MNS) – Electrical and I&C	\$165.00
John Robinson (John Robinson, LLC) - Permitting/Regulatory Compliance Lead.....	\$160.00
Sun Liang, PhD, PE (The Metropolitan Water District of Southern California) - MWD Water Purification Engineer	Non-Chargeable

Employee time will be billed in accordance with the rate schedule listed above. These rates are effective through June 30, 2023. Expenses and subconsultants and other similar project related costs are billed out at cost plus 12%. Our rates are \$6.00/hr for office consumables.

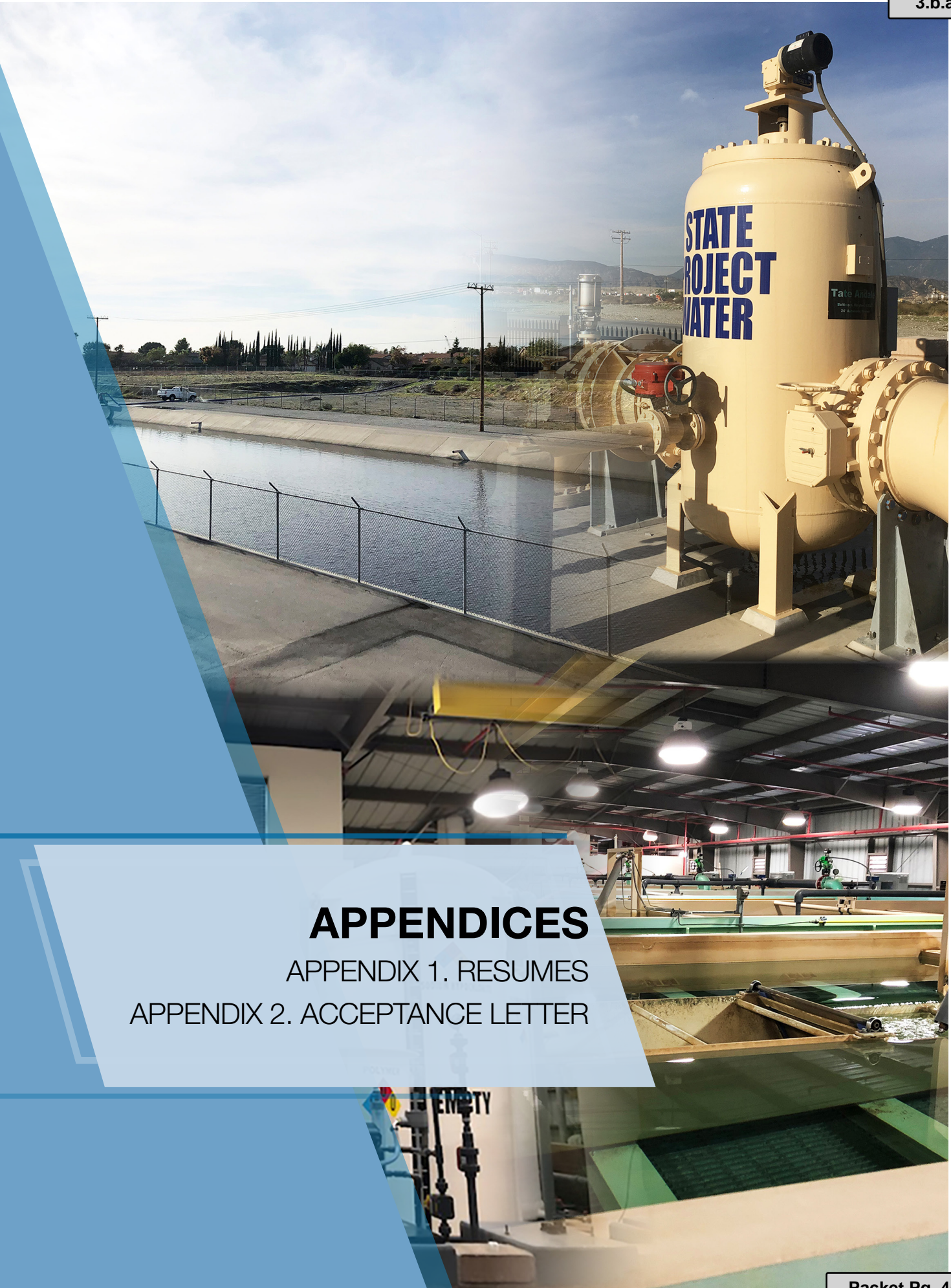

APPENDICES

APPENDIX 1. RESUMES

APPENDIX 2. ACCEPTANCE LETTER



Jamal Awad, PhD, PE

Project Manager



Education: PhD, Environmental Engineering, Marquette University; MS, Civil and Environmental Eng., UW-Madison; BS, Civil Engineering, Louisiana Tech University.

Professional Registration: Professional Engineer: California, Wisconsin, Illinois, Texas, Arizona

Connected: American Water Works Association; International UV Association-Americas Regional Vice President.

PE Civil CA (Issued: July 16, 1993; Expiration Date: September 30, 2021)

PE Civil TX (Issued April 23, 2012; Expiration Date: March 31, 2020)

Years with GHD: 6 | Home Office Location: Irvine

Professional Qualifications: Dr. Awad has over 25 years of experience with extensive experience in water quality, water treatment planning and engineering. Jamal is sought after nationally to support creative implementation of engineering solutions and innovative

technologies assessments. An example of Jamal's leadership and is his work for the Blue Ribbon Panel that assisted the California DDW in the development of guidelines for Title 22 UV disinfection.

Distinguished Qualifications

- International UV Association-**Founding Member**, former **Regional Vice President**-Americas, and current **Board Director**
- Member of the **Blue Ribbon Panel** that assisted the California Department of Public Health in the development of guidelines for **Title 22 UV disinfection**
- Past **Chair of the Water Quality Division, AWWA California-Nevada Section**
- Technical Consultant for **AWWARF Research Advisory Council** on 2003 Project Funding
- Water Quality Manager for the Long Beach Water Department (**34th largest City in the US**).

Awards

- AWWA CA-NV Section; 1998 Chair's **Award for dedication and leadership** in providing ongoing training to Section members.
- AWWA CA-NV Section; 2002 **Section's Service Award** for service as Water Quality Chair.

Feature Projects

Deputy Project Manager/Technical Lead, Owner Engineer for GRIP AWTF, Water Replenishment District of Southern California | Lakewood, CA

Technical Services Lead as the Owner Engineer for the Water Replenishment District of Southern California's (WRD's) GRIP Advanced Water Treatment Facility (AWTF). The AWTF, with an initial capacity of 15 mgd and a maximum capacity of approximately 30 mgd, will treat tertiary effluent from the LACSD using microfiltration (MF)

and reverse osmosis (RO) followed by ultraviolet advanced oxidation (UVAOP) using chlorine as an oxidant. Effluent from the AWTF will be used for groundwater recharge. The initial phase is under startup, and it will achieve a significant milestone for WRD's water independence from imported water. Alternative Project Delivery is being used to implement the AWTF with an estimated construction value of \$115 millions.

As the Owner Engineer for the project, GHD prepared all contractual and engineering documents for the selection of the Design-Build (DB) Entity. The engineering documents establish the technical and design requirements with enough details for the DB Entity to develop a guaranteed maximum price (GMP) for the proposed project. The design requirements cover both the design/construction and the 4-year Transition Operation Period to be performed by the DB Entity.

Technical Consultant and Task Lead, Groundwater Recovery Enhancement and Treatment (GREAT) Program's APWF Project, City of Oxnard | Oxnard, CA

Dr. Awad served as technical consultant for this project, the focus of which is to use existing water resources more efficiently. A major component of the GREAT program is the use of recycled water for multiple beneficial uses including irrigation of edible food crops, landscape irrigation, injection into the groundwater basin that forms a barrier to seawater intrusion, and other possible industrial uses. The recycled water for reuse will be generated by the new AWPf. The AWPf will treat the secondary water using a multiple-barrier treatment train consisting of microfiltration/ultrafiltration, reverse osmosis, and **UVAOP processes using peroxide as the oxidant**. In addition to the key objective of producing purified water, the AWPf



will be open to the public and have educational, visitor, and research functions.

Jamal performed detailed evaluations of current UV photolysis equipment and recommended the selected equipment for the project. He also established the regulatory requirement with the CDPH regarding the advanced oxidation facilities.

Other Selected UV Projects

- **Technical Consultant and Design Lead** for the Cedar Rapids' J-Avenue (42 mgd) and Northwest (40 mgd) WTPs UV disinfection facilities. The UV reactors (**Trojan 30" Diameter**) are **first** to be designed for **virus inactivation** under EPA UVDGM requirements.
- Reviewer of **UV Photolysis** and **UV/peroxide Advanced Oxidation** for **Aurora's** 50-mgd purification to provide **South Platte River Supply** multiple treatment barriers. UV advanced oxidation selected to provide *Cryptosporidium* inactivation, micro-pollutant control, and destruction of taste and odor causing compounds and NDMA.
- Technical Consultant for the **Gibson Island UV Photolysis** and **UV/peroxide Advanced Oxidation**. The UV process was designed for the removal of **NDMA** (1-log) and **1,4-dioxane** (0.5-log). The initial capacity is 50 Ml/day and the ultimate capacity is 100 Ml/day. Trojan UVPhox™ LPHO was selected for the UV process.
- **Technical Consultant, AWT Demonstration Plant**, Water Repurification Project and Indirect Potable Reuse/Reservoir Augmentation Demonstration Project, City of San Diego, CA for the Advanced Oxidation aspects of the project. Based on the results from the AWT Plant pilot testing program, the City proceeded with the next phase of the program – design and construction of 1-mgd demonstration project. In particular, provided assistance in the development of the Testing and Monitoring Plan and with regulatory permitting.
- **Technical Director and Design Lead** for the Elsinore Valley MWD 9-mgd Canyon Lake WTP UV facilities (**Calgon 24" Reactor**) to meet the disinfection requirements of Long Term 2 Enhanced Surface Water Treatment Rule (LT2ESWTR) and the disinfection byproducts requirements of the Stage 2 Disinfectants and Disinfection Byproduct Rule (Stage 2 DBP Rule). The **Provided complete functional controls of the new disinfection system to the SCADA integrator**.
- **Technical Consultant** and Process Lead for the San Francisco Public Utilities Commission (SFPUC) 315-mgd **UV disinfection for its unfiltered Hetch Hetchy Aqueduct (HHA) supply** in compliance with the Long Term 2 Enhanced Surface Water Treatment Rule (LT2ESWTR). The **Calgon's 12-Chevron reactors** are grouped into two independent 160-mgd treatment trains, to optimize system hydraulics and facility maintenance.
- Project Manager of the Alternative Analysis and Conceptual Design for the expansion of the **SFPUC's SVWTP from 120 to 160 mgd** sustained capacity. Project Manager for the Conceptual Design of the effluent Chlorine Contact Basin, future UV facility, and Storage reservoir. Assisted the **Value Engineering** team based on the preliminary design of the proposed facilities.
- **Technical Lead for Validation and Acceptance Testing, Winnipeg WTP, Canada**. Conducted on-site validation and acceptance testing for the 132-192-mgd UV disinfection facility. The UV facility was designed to meet current and future water quality and flowrates, initially for an **unfiltered supply** (UVT of 75 percent), then for a filtered supply after the WTP is constructed (UVT of 90 percent). The **UV system, supplied by Calgon, consists of six Sentinel 48 inch UV reactors**. The design flexibility allowed the City to implement the UV Disinfection Facility ahead of the WTP construction. The onsite validation testing included a total of 38 system runs involving multiple flowrates, UVT levels, lamp power settings and number of lamps plus blanks and other QC samples. The selected UV reactor was operated with either 2 or 3 lamp banks. The resulting RED varied from 12 to 54 mJ/cm².
- Task Lead for process design, preliminary design, equipment selection, final design, and regulatory approval for Eastern Municipal Water District's 50-mgd UV disinfection facility (**Trojan 24" Reactor**) and North Shore Water Commission's 18-mgd UV disinfection facility (**Trojan 24" Reactor**). The facilities are first to be approved for primary disinfection with *Cryptosporidium* and *Giardia* credits in California and Wisconsin
- **Preliminary Designs Lead and Senior Consultant** for the Clayton County Water Authority (CCWA)-three surface WTPs (**Wedeco K-143 Reactor**)– Hooper (20 mgd), Smith (12 mgd) and Freeman (10 mgd).
- **Technical Consultant** for the LADWP 600 mgd LAAFP UV Disinfection project. The UV disinfection facility would bring the LAAFP into compliance with the LT2 requirements for unfiltered water supplies.
- **Technical Consultant** for the Long Beach Water Department (LBWD) Demonstration Testing of UV and Chlorine Dioxide for Biogrowth Control and Pathogen Inactivation Systems as Pretreatments for **Seawater Desalination NF/NF Prototype**.



Hector Ruiz, PE

Project Advisor



Education: Master of Science, Civil and Environmental Engineering and Science, Stanford University; Bachelor of Science, Civil Engineering, California State Polytechnic University, Pomona

Memberships/Affiliations: American Water Works Association; California Water Environment Association

PE Civil CA (Issued: February 9, 1996; Expiration Date: June 30, 2020)

Years with GHD: 1 | Home Office Location: Irvine

Professional Qualifications: Hector has more than 25 years' experience in water and wastewater engineering and management, including design, construction, and operation of improvement and upgrades to water booster pump stations, lift stations, pressure reducing stations, water distribution and transmission mains, gravity sewer mains, and sewage force mains. Hector's experience with water and wastewater systems includes working side-by-side with maintenance and operations personnel on the upgrade, retrofit, condition assessment, and replacement of an agency's vertical and horizontal assets. Hector's experience in the public sector includes the oversight and management of water and wastewater treatment personnel and facilities for a public agency in South Orange County. As a former head of engineering and as a general manager of a public agency, Hector brings the experience of having worked for many years with water and wastewater operators and maintenance technicians in effectively planning and managing the rehabilitation, upgrade, and replacement of an agency's assets, and as such, understands the value of asset management from an owner's perspective.

Asset Management, Engineering, and Operations – Public System General

Hector Ruiz managed the Trabuco Canyon Water District, a California public water utility with a five-member Board of Directors providing retail water, wastewater, and recycled water services. Hector was responsible for the overall management of assets for the agency's water/wastewater/recycled water facilities and infrastructure including a wastewater treatment and recycling plant, a surface water treatment plant, a groundwater treatment plant, several miles of water transmission and distribution mains, several miles of gravity and force mains, water and sewerage pump stations, water storage reservoirs, and various pressure reducing stations and two open reservoirs with earthen dams.

Annually and as required throughout the fiscal year, Hector worked with staff and consultants in the preparation of the agency's budget, capital improvement program (CIP), rates, and reserves. Specifically, Hector's water supply, treatment, and conveyance experience includes:

- Managed water operations and distribution staff responsible for seven above grade reservoirs, eight water booster pump stations and multiple pressure zones serving elevations from 1,000 to 1,600 feet.
- Daily management and oversight of operations/maintenance staff responsible for:
 - The Dimension Water Treatment Plant a surface water treatment facility, supplied with untreated/imported water from the Colorado River.
 - Groundwater treatment facility supplied with seasonal untreated water under the influence of surface water.
 - Recycled water treatment facilities producing and distributing recycled water.
 - Urban runoff/capture/reuse systems for supplementing the recycled water system.
 - Worked with the maintenance department in replacing a legacy CMMS system.
- Worked closely with engineering, operations and maintenance departments in effectively troubleshooting various issues/problems/ and inefficiencies related to:
 - Potable water treatment, storage, and distribution system; including pressure reducing station and booster pump station failures and water main breaks.
 - Wastewater collection and pumping system, including pump station failures, sewer overflows and spills, and force main breaks.
 - Recycled water production, pumping, and distribution system operation and maintenance.
 - Management of a legacy Supervisory Control and Data Acquisition (SCADA) system that interfaced with multiple communication technologies (internet, low frequency radio, and broadband radio).
- Worked closely with engineering to design and construct various projects utilizing in-house resources. Projects included CEQA, FEMA grant funds, Prop 84 funds, and SRF funds.



- Successfully led the procurement of FEMA funds for projects totaling over \$3M. The projects involved complex environmental constraints and construction within creeks, streambeds, and public and private properties. Negotiated the procurement of 3 public and three private easements for the FEMA funded sections.

Project Management and Engineering Experience

Over the span of approximately 18 years, Hector has managed several water and wastewater projects, and led project teams with staff ranging from 2 to up to 50+ people and projects that ranged from \$25,000 to over \$1 million in consulting fees. Hector's Project Management and engineering experience includes:

- **Design/Build Experience.** Lead project and process engineer for \$10 million Design Build improvements to various wastewater and recycled water facilities. As the prime contractor, worked directly with the mechanical, electrical, and controls subcontractors, and vendors in construction of the various plant upgrades and improvements.
- **Water Treatment Projects.** Design Engineering and Operations of a groundwater treatment facility including pilot and full-scale operation, testing, and maintenance of various unit treatment process including ozone, conventional treatment technologies, dissolved air flotation, GAC, and membranes.
- **Recycled Water Treatment Projects.** Master planning and evaluation for the expansion of water reclamation facilities, including facilities with reverse osmosis, lime saturation for pH control, concentrate disposal, and micro-filtration of secondary effluent.
- **Wastewater Treatment Projects.** Project management and engineering for the design, and construction of water treatment, wastewater treatment, and water recycling facilities ranging up to 15 MGD. Performed various design/construction management services for upgrades, expansions, and rehabilitation projects to wastewater facilities in Southern California and Arizona. Projects included rehabilitation and expansion of unit treatment facilities and pump stations. Various plant improvements included conversion of reactors to flow through activated sludge systems with nitrogen removal, and increasing treatment and hydraulic capacity.
- **Sewer System Projects.** Project management and engineering for the design and rehabilitation of major sewer gravity trunk lines and force mains, including use of HDPE pipe. Trunk line sizes ranged from 16-inch to 27-inch diameter. Rehabilitation projects for gravity sewer mains ranging from 14-inch through 22-inches and force mains of up to 12-inches. Rehabilitation technology included HDPE force main

designs, bridge crossings, and creek crossings requiring significant permitting and approval by various local, state, and federal agencies.

Operations Management Experience

Over the span of approximately 18 years, Hector has worked on projects that involved hands on operation of facilities at a pilot scale and full scale level. Hector's operation's experience includes:

Operations Engineer – Groundwater Treatment Facility, Orange County, CA

Design Engineer and Operations lead for year-long operation of groundwater treatment facility that evaluated pilot and full-scale operation, testing, and maintenance of various unit treatment process including ozone, conventional treatment technologies, dissolved air flotation, GAC, and membranes, and ion-exchange resins.

Results from the project were used to construct a full-scale groundwater treatment facility utilizing nano-filtration membranes.

Project Manager and Operations Engineer – Groundwater Treatment Facility, Orange County, CA

Prepared design criteria for increasing the operational efficiency of groundwater treatment facility. Scope of service included the collection and treatment of concentrate produced and being disposed with membranes. The treated concentrate was blended with the main facility's product water and the "new" brine was disposed of to the sewer. The project increased well production while decreasing discharge of flows to the sewer resulting in significant costs savings.

Prepared test protocols and trained agency water treatment plant operators in the proper evaluation, cleaning, loading and unloading of ultra-filtration membranes at a full-scale treatment facility. Evaluation included development of standard operating procedures (SOP) and training video for use by the agency's operators.

Project Engineer - Advanced Water Recycling Treatment Plant Upgrades and Improvements, El Segundo, CA.

Master planning and evaluation for the expansion of water reclamation facilities, including facilities with reverse osmosis, lime saturation for pH control, concentrate disposal, and micro-filtration of secondary effluent.

Completed design, construction management, and startup of lime saturation for control of hardness and calcium carbonate buildup at injection wells.



Chris Hertle

Blue Ribbon Panel Chair



Qualified: Bachelor of Engineering, Chemical (Hons), Master of Philosophy, Environmental and Biological Sciences, Adjunct Professor – Advanced Water Management Centre - University of Queensland

Connected: Fellow, International Water Association; Fellow, Engineers Australia; Member of Research Advisory Committee –Australian Water recycling Centre of excellence; Member American Water work Association; Member WateReuse; Member, Australian Water Association; Member, Water Environment Federation, Member, International Desalination Association.

Registrations: CA#CH6292 Issued September 2007, Expires December 2019

Years with GHD: 26 | Home Office Location: Irvine, CA

Professional Summary: Chris is a Chemical Engineer with over 35 years' experience in municipal and industrial water, wastewater and solid waste management, particularly with innovative solutions for resource recovery schemes that recovery water, carbon and nutrients. This has including media and membrane filtration, ion exchange and advanced oxidation systems This has covered investigations, pilot plants, design, specification, tendering, installation, commissioning and operations. Chris has been involved in numerous water reuse schemes and projects including the Western Corridor Recycled Water Scheme, the first membrane bioreactor in Australia and the world's first water recycling facility in a brewery at Fosters. Chris has a passion for challenging designs and coming up with alternative approaches that are cost effective. Chris has written more than 40 technical publications in the water and wastewater field.

Project manager | Mt Crosby and North Pine WTPs Alum Sludge management strategy | Brisbane, Australia

Study manager for alum sludge residue management at the 3 largest water treatment plants in Brisbane.

Process engineer | Glenmore WTP | Rockhampton, Australia

Study manager for Glenmore WTP capacity and quality assessment. Recommendations included on-line monitoring of raw water to control coagulant dosage automatically, replacement of the lime slaking system, implementation of a filter to waste and clean out of the sludge lagoons.

Process engineer | Glenmore WTP | Rockhampton, Australia

Study manager filter to waste study. Utilised particle counting technology to implement a filter to waste strategy for the dual media after backwash. The outcome was more reliable turbidity for filtered water through the whole filtration cycle.

Process engineer | Molendinar WTP | Gold Coast, Australia

Study manager for Molendinar WTP chlorine disinfection assessment. Comparison of alternative chlorination options. Compared existing chlorine gas dosing to sodium hypochlorite and onsite hypo production. The preferred alternative was to change to NaOCl dosing using delivered product.

Process engineer | Molendinar WTP | Gold Coast, Australia

Study manager filter to waste study. Utilised particle counting technology to implement a filter to waste strategy for the dual media after backwash. The outcome was more reliable turbidity for filtered water through the whole filtration cycle.

Process Design | Western Corridor Recycled Water Scheme | Brisbane, Australia

Process team lead for GHD in developing the concept for the WCRWS. This lead to the construction of a \$2.4 billion scheme providing 60mgd of purified recycled water from 3 AWWFs to South East Queensland power stations, industry, agriculture, and Wivenhoe dam system.

Project Director, The Smiths Snack Food Company | Brisbane, Australia

Concept Design and Tender Phase Services, Treated Wastewater. Concept design and tender phase services of water management plant for The Smiths Snackfood Company. Allows recycle of treated wastewater for non-product contact uses (anaerobic, aerobic treatment followed by membrane filtration and reverse osmosis).

Design Manager, Lion Nathan XXXX Milton Brewery | Brisbane, Australia

Concept design and project management of the design and construct of water management plant for Lion Nathan XXXX Milton brewery. Allows recycle of treated wastewater for non-product contact uses (anaerobic, aerobic treatment followed by membrane filtration, reverse osmosis, UV and chlorine dioxide disinfection).



Process Design Carlton & United Breweries | Yatala, Australia

Concept design of water management plant for Carlton & United Breweries Yatala brewery. Allows recycle of treated wastewater for non- product contact uses (anaerobic, aerobic treatment followed by DAF, membrane filtration, reverse osmosis and chlorine disinfection).

Project director, peer review, Pacific Beverages | Warnervale, Australia

Concept Design and Tender Phase Services. Concept design and tender phase services of water management plant for Pacific Beverages (CCA, SABMiller) Warnervale brewery. Allows recycle of treated wastewater for non- product contact uses (anaerobic, aerobic treatment followed by MBR and reverse osmosis).

Project Director, Australian Country Choice | Brisbane, Australia

Abattoir recycled water assessment –Assessed options for treatment and recycle of treated effluent for reuse on site in excluding processing area.

Process engineer, JBS Swift | Brisbane

Assessed option and prepared concept design for treating wastewater at abattoir to allow total recycle into the works at large beef abattoir in SE Queensland. Including HACCAP & risk assessment.

Lead Process design, Confidential | China

Conducted options study, concept design and specification of preferred option to treat wastewater from large barn style dairies in China. The plant has to achieve very low levels of COD and nutrients. Plant includes sand removal, fine screening, high rate anaerobic treatment Anaerobic flotation reactor, activated sludge. Anammox and Fenton's reagent.

Coal Seam Gas Water management Training

Prepared and delivered over 10 papers and technical training courses in Australia and overseas on water and salt management in the coal seam gas sector.

Coal Seam Gas Salt Management

Conducted extensive review of options for salt management in the coal seam gas sector including brine concentration, crystallisation and selective salt recovery.

Options Assessment Brine management, Coal Seam Gas QLD Australia

Review of options for management of brine from coal seam gas .associated water reverse osmosis plant. Options included enhanced wind evaporation, batch operated RO to increase recovery, thermal systems (brine evaporators and crystallisers), recovery of commodity chemicals (soda ash, hydrochloric acid).

Wastewater Treatment and Disposal Options, Paper Plant Swanbank, Australia

Process review of treatment and disposal options for wastewater from the proposed Swanbank Paper plant. Options involved the reuse of water from the Bundamba Sewage Treatment Plant and development of a Zero Liquid Discharge option.

Study of Water Use and Wastewater Production, CSBP Wesfarmers, WA Australia

Detailed study of water use and wastewater production from a fully integrated chemical and fertiliser manufacturing facility. Design of reuse and treatment options to aim for zero discharge of heavy metals and nutrients.



Mark Donovan, PE

Treatment Evaluations & 30% Design Documentation Process Lead



Qualified: MS, Engineering (Chemical), California State University, Long Beach, California, BS, Chemical Engineering, University of New Hampshire, Durham, New Hampshire

Connected: Member – American Institute of Chemical Engineers, American Membrane Technology Association, WaterReuse Association

PE Chemical CA (Issued: September 21, 2007; Expiration Date: December 31, 2021)

PE Civil HI (Issued: December 10, 2013; Expiration Date: April 30, 2020)

Years with GHD: 7 | Home Office Location: Irvine

Professional Summary: Mark is a Senior Process Engineer with over 20 years of experience in membrane-based water treatment system process design. Mark has provided full scale system design, operations support, and treatment process improvement/optimization

services to municipal and industrial water treatment facilities worldwide. Furthermore, Mark is very well versed in the Owner Engineer role for collaborative, Alternative Delivery water projects, serving this role in several prominent projects in Southern California. Mark's unique blend of detailed design and Owner's Engineer experience makes him ideal for this role.

Senior Process Engineer - Owner Engineer for GRIP AWTF Water Replenishment District of Southern California, Lakewood, CA

Senior Process/Membrane Engineer on **Owner's Engineer** team for the Water Replenishment District of Southern California's (WRD's) GRIP Advanced Water Treatment Facility (AWTF), delivered under a **Progressive Design Build contract**. The AWTF, with an initial capacity of 12 mgd and a maximum capacity of approximately 25 mgd, will treat tertiary effluent from the LACSD using ultrafiltration (UF) and reverse osmosis (RO) followed by ultraviolet advanced oxidation (UVAOP). As the Owner Engineer for the project, GHD prepared all contract and engineering documents for the selection of the Design-Build (DB) Entity, performed design review, and is currently overseeing the commissioning process.

Program Manager – Senior Process Engineer Doheny Desalination Project, South Coast Water District | Dana Point, CA

GHD is currently the Program Manager/**Owner's Engineer** for South Coast Water District for this 5 -15 mgd ocean desalination project. GHD's role for the current planning stages of the project includes preparation of the Preliminary Design, managing and preparing the Environmental Impact Report and numerous supporting technical studies, managing the Permitting process, evaluation of Project Delivery Methods including development of the financial model and Value for Money Analysis, and managing the Public Outreach process. Once the project moves into the **Design Build Operate Maintain** execution phase, GHD will prepare bid documents, and perform CM and OE duties on behalf of the District.

Senior Process Engineer Seawater Desalination Plant, Poseidon Resources | Carlsbad, CA

GHD performed the **Owner's Engineer** role for the 50 million gallons per day seawater reverse osmosis desalination facility delivered under an EPC/**Alternative Delivery** contract. Provided technical review of all aspects of the seawater desalination plant process design. Coordinated and provided technical support for obtaining the DDW Drinking Water Permit, which is a first in California for a seawater desalination plant of this magnitude.

Senior Process Engineer Seawater Desalination Plant, Poseidon Resources | Huntington Beach, CA

Currently performing the **Owner's Engineer** role for the 50 MGD seawater desalination project, which will be delivered under an EPC/**Alternative Delivery** contract . Recent work included collaborative process design reviews, and detailed review of bids and assessment of the contractors Guaranteed Maximum Price.

Senior Process Engineer - Owner Engineer Seawater Desalination Plant, Confidential Client, Texas

Currently performing the **Owner's Engineer** role for a 25 MGD seawater desalination project, which will be delivered under an EPC/**Alternative Delivery** contract . Mark's role includes process design criteria review for the contract documents and collaboration with the Design team on value engineering.

Senior Process Engineer / Project Manager City of Beverly Hills, RO Water Treatment Plant Rehabilitation | Beverly Hills, CA

The City of Beverly Hills engaged GHD for the detailed design of their RO Water Treatment Plant Rehabilitation Project. The 3 MGD RO plant, which was delivered under



a **Design-Build-Operate-Finance** agreement in 2003 and taken over by the City in 2008, was in need of various repairs and improvements.

Mark lead the design team through many upgrades and improvements to the plant focused on addressing corrosion, various treatment process improvements, enhancing operator safety and control, enhancing plant reliability, evaluation of possible plant expansion, and ensuring suitable finished water quality. Coordination with DDW and other permitting agencies was also required as part of the plant improvements.

**Senior Project Engineer
Lenain WTP Facility Master Plan, Utilities
Department | Anaheim, CA**

GHD developed a comprehensive Facility Master Plan including cost and schedule for the replacement and rehabilitation (R & R) of facilities as well as expansion of the LWTP from 15 to 20-22 mgd. This work included performing significant treatment optimization studies including Jar testing of various coagulants and hydraulic assessments of plant and distribution system. Also established the Asset Management framework for the City and implementing the framework at the LWTP. Also performing detailed facility condition assessments at the plant.

**Senior Process Engineer / Project Manager
City of San Diego, Otay Water Treatment Plant
Chlorine Conversion | San Diego, CA**

The Otay Water Treatment Plant is a surface water treatment plant located adjacent to the Lower Otay Reservoir, and has a capacity of 34 mgd. The treatment process includes a chlorine dioxide contact chamber, flocculation and sedimentation, and media filtration, followed by chloramination. GHD recently completed a Design/Build project for the conversion from chlorine gas to Onsite Sodium Hypochlorite, including upgrades to the chlorine dioxide generators.

Mark lead an interdisciplinary team of engineers to complete the process, mechanical, electrical, I&C, and civil/structural design modifications required for the conversion. Additionally, Mark has coordinated with Operations Staff and the Contractors to keep the plant operational during all construction activities.

**Project Engineer
West Basin Municipal Water District | CA, USA**

Provided operations support and performance assessment of three separate advanced water treatment facilities utilizing MF, RO and Advanced Oxidation to produce four different grades of recycled water totaling over 25 MGD. Conducted R&D studies to improve plant performance, and provided management and operations staff recommendations regarding system operating conditions, membrane cleaning, troubleshooting, maintenance, and process optimization.

**Project Engineer
BP-Carson Refinery | CA, USA**

Assessed and optimized performance of industrial RO system treating water from nearby AWTF for use in the oil refinery. Designed RO system upgrades to increase RO system capacity. Provided RO system monitoring reports and recommendations regarding operating conditions and system optimization.

**Senior Process Engineer
City of Palo Alto, AWTF Feasibility Study and
Preliminary Design | Palo Alto, CA**

Mark was Senior Process Engineer for the City of Palo Alto's Feasibility Study and subsequent Preliminary Design for an Advance Water Treatment Facility utilizing MF and RO to improve the quality of recycled water for the local area. Mark lead the development of various plant layouts, brine disposal options, and cost estimates.

**Membrane/Membrane System Manufacturing
Sector**

With 10 years of experience in the membrane and membrane system manufacturing sector, Mark designed and manufactured dozens of large scale membrane systems treating various water sources for municipalities and various industrial markets. Mark also performed on-site system start-up and troubleshooting services, and pilot testing in a variety of applications.



Paul Hermann, CPEng

Design-Build Services Lead



Qualified: Bachelor of Engineering – Civil, Environmental, Queensland University of Technology, Australia

Connected: Institution of Engineers, Australia

Years with GHD: 19 | Home Office Location: Irvine

Professional Summary: Paul is a lead water/wastewater engineer and GHD's Water Market for the west region. He has extensive design experience in water and wastewater infrastructure, including large conveyance pipelines, pumping stations, and treatment facilities. Paul was the Owner's Engineer/Project Manager for the \$115M WRD Albert Robles Center (ARC) Advanced Water Treatment Facility (AWTF) Progressive Design Build project, and he played a key role in the successful delivery of the Carlsbad SWRO Desalination Plant Pipeline and Western Corridor Recycled Water Project.

Owner Engineer/Project Manager Albert Robles Center Advanced Water Treatment Facility | WRD | Lakewood, CA

Owner's Engineer and Project Manager for the Water Replenishment District of Southern California's (WRD) Albert Robles Center \$115 million advanced water treatment facility. The Progressive Design-Build (DB) delivery of the project has very unique aspects including a collaborative process to select the DB Entity and establish a Guaranteed Maximum Price (GMP). Paul led the development of the project design criteria which communicated all technical requirements to the DB Entities in a creative format to facilitate submittals of proposals, the collaborative discussions, and the evaluations of the proposals. During project execution, Paul led the integration of the DBE with the multidisciplinary teaming partners and subcontractors to deliver an award-winning, innovative treatment plant and injection well system.

Project Director Carlsbad SWRO Desalination Plant Pipeline | Poseidon Water/San Diego County Water Authority | Carlsbad, CA

Performed in the role as the Owner's Engineer for the project, which comprised the engineering, procurement, and construction of both the 50 MGD seawater reverse osmosis desalination facility, in addition to approximately 10 miles of new 54-inch steel conveyance pipeline. He was the primary contact for the owner's team with respect to technical services and provided general oversight and independent assessment of various aspects of the project. Key tasks completed include project and site coordination activities, scope book and specification reviews, drawing and design reviews, materials/durability/ asset life reviews, consultation with local authorities and utilities, and providing general project management and technical assistance to the client. Works also included the coordination and development of compliance documentation with the California Department of Public

Health, and Pilot Plant development, compliance and oversight.

Post Plant Operation: While the Desalination Plant has been operational for a few years now, Paul still maintains involvement through the Owner's obligation to make project modifications to accommodate changes in legislation and/or permitting requirements. At present, Paul manages for Poseidon the upcoming wetlands restoration, new Plant intake structure and discharge modifications, and the detailed design of a new pilot system required to replicate the operation of the proposed new intake structures.

Technical Services Lead Doheny Desalination Project | South Coast Water District | Dana Point, CA

GHD is currently the Program Manager/Owner's Engineer (OE) for South Coast Water District for this 5 -15 mgd ocean desalination project. GHD's role for the current planning stages of the project includes the completion of the Preliminary Design, development and completion of the Environmental Impact Report and numerous supporting technical studies, managing the Permitting process, evaluation of Project Delivery Methods including development of the financial model and Value for Money Analysis, and managing the Public Outreach process. Once the project moves into the execution phase, GHD will prepare bid documents, and perform CM and OE duties on behalf of the District.

Project Manager Seawater Desalination Plant, Confidential Client | USA

Currently performing the Owner's Engineer role for a 25 MGD seawater desalination project, which will be delivered under an EPC/ Alternative Delivery contract. Paul is currently managing the development of contract documents, preliminary cost estimating, and project scheduling while completing the preliminary design - as required to satisfy both permitting and financial/funding



requirements. Further, GHD is responsible for all environmental permitting for the project.

**Project Director
Western Corridor Recycled Water Project |
Department of Infrastructure, Queensland
Government | Queensland, Australia**

Performed the role of owner's engineer for both the Eastern Pipeline Alliance and Western Pipeline Alliance. The system, at a cost of ~AU\$2.4B, involved the construction of three advanced water treatment plants (AWTP) (Bundamba, Luggage Point, and Gibson Island), which provide purified recycled water to Swanbank and Tarong Power Stations whilst enabling excess to be discharged to Wivenhoe Dam. The combined conveyance system was approximately 125 miles of up to 60-inch diameter pipeline and 9 pumping stations with capacities ranging between 1.85 to 45 MGD. The primary role was to ensure that the owner/client had involvement in the design process; ensuring compliance occurs with the scope of work and technical criteria and that best engineering and construction practice was implemented and maintained. Another significant role was to ensure that the interfaces between all five Alliances occurred fluently as both of the pipeline Alliances had significant interfaces with all three AWTPs. Eastern Pipeline Alliance provide the pump stations and transfer pipe work between the AWTPs whilst Western Pipeline Alliance has interfaces with all five Alliances as it is responsible for the communications network in addition to providing pump stations and transfer pipe work.

**Principal-in-Charge
Strategic Infrastructure Management | Port of
San Diego**

Principal overseeing the complete targeted data collection (new field data and currently held as-builts and condition survey reports), asset register development, risk-based preventative maintenance and renewals plan, long-term financial forecast and budget optimization strategy for all Port owned and maintained waterfront, parks, roads and building assets.

**Owner Engineer/Project Manager
GRIP AWTF WRD | Lakewood, CA**

OE and Project Manager for WRD's Groundwater Reliability Improvement Program (GRIP) \$100-million advanced water treatment facility (AWTF). The Progressive DB delivery of the project has very unique aspects including a collaborative process to select the DB Entity and establish a Guaranteed Maximum Price (GMP). Lead the development of the project design criteria which communicated all technical requirements to the DB Entities in a creative format to facilitate submittals of proposals, the collaborative discussions, and the evaluations of the proposals. The selection of the DB Entity with a single GMP was completed in April 2016,

and final contract is currently being prepared. The project is scheduled to be completed mid-2018.

Another unique aspect of the project is the co-location of GHD key technical staff with WRD staff. The key DB Entity staff will also join the team enhance the delivery of the project. The OE services will include CM services, startup and commissioning, and supervision of the transitional operation of the facility.

**Project Manager
Private Client | Seawater Reverse Osmosis
Desalination Plant in the Lana'i, Hawaii.**

Currently performing the role of Project Manager for GHD on this project. The private client has engaged GHD as part of the project team for the design and construction of a seawater reverse osmosis desalination facility with the plant to be developed in 2.5 MGD stages, to an ultimate capacity of 10 MGD.

- GHD's current role includes key components of the desalination project, including the following:
- Pilot Plant design and construction guidance, and analysis;
- Analysis of numerous contract vehicles, and the determination of the optimal option noting the key criteria of location, plant size, seasonal demand requirements and constraints, development / retail sale opportunities, etc.
- Design of the treatment process, including the coordination with the Department of Health, and chemical usage considerations.
- Cost benefit analysis of different processes, in terms of both upfront capital and ongoing long term operation & maintenance expenditure.
- Power supply requirements,
- GHD is the Designer of Record for the seawater reverse osmosis treatment process.

**Project Director
100 MGD Seawater Reserve Osmosis
Desalination Plant, Private Client | Northern
America**

Currently part of the team supporting our client with project planning, project strategy, and procurement advice, and with the concept development and concept design for a Seawater Reverse Osmosis Desalination Plant with an ultimate capacity of 100 MGD. This includes associated infrastructure including the intake and outfall, power supply, etc. The end intent is the production of a documentation package suitable for financing, signing and executing an Engineering, Procurement and Construction (EPC) Project.



Sridhar Sadasivan, PE, SE

Design-Build Services – Contract Documents



Qualified: B.S. Civil/Environmental Engineering, University of Bombay, India, 2002; M.S. Structural Engineering, University of Cincinnati, 2004; Professional Civil Engineer: CA; Professional Structural Engineer: CA

PE Civil CA (Issued July 31, 2008; Expiration Date: December 31, 2020)

PE Structural CA (Issued December 18, 2013; Expiration Date: December 31, 2021)

Years with GHD: 0.5 | Home Office Location: San Diego

Professional Summary: Backed by over 15 years of hands-on experience in design and construction of facilities for environmental projects, Sridhar has been involved in planning, design, and construction of more than ten treatment plants, 50 reservoirs, ten pipelines, 15 pumping stations, and eight chemical facilities, as well as in the siting/design of four administration buildings. This work typically involves design-bid-build and alternate delivery processes, serving in such roles as Project Manager, Design Manager, Lead Civil Engineer, and Lead Structural Engineer. Additionally, he is an asset in the field, having provided

construction support and inspection services for several infrastructure projects, including resident engineering services at a wastewater treatment plant and at several sewer pipeline construction sites.

Project Engineer / Lead Structural Engineer Longfellow Recycled Water Tank and Pipeline | Eastern Municipal Water District | Winchester, CA

Sridhar served as the project engineer, lead structural design engineer, and lead civil engineer during the design and construction of a 5-million-gallon (MG) welded steel tank, 4,000 linear feet (LF) of 36-inch diameter steel pipeline, and 25,000 cubic yards (CY) of excavation, as well as for miscellaneous sitework.

Project Manager Daily II Reservoir and Pipeline Design | Eastern Municipal Water District | Menifee, CA

Sridhar served as the project manager, lead structural design engineer, and lead civil engineer during the preliminary and final design of a 2 MG welded steel tank, 2,000 LF of 12-inch PVC pipeline, and 18,000 CY of excavation, as well as for miscellaneous sitework. Preliminary design involved a siting study for a 2 MG welded steel reservoir with evaluation of potential sites primarily based on operations and geotechnical considerations.

Project Engineer Benton Recycled Water Storage Tank and Pipeline | Eastern Municipal Water District | Perris, CA

Sridhar served as the project engineer and lead structural design engineer during the design and construction of a 2 MG welded steel tank, 9,000 LF of 24-inch steel pipeline, and 65,000 CY of excavation, as well as for miscellaneous sitework.

Project Manager Seismic Study of Reservoirs | Fallbrook Public Utility District | Fallbrook, CA

Sridhar served as the project manager and lead structural design engineer for this seismic evaluation of eight (8) welded steel reservoirs (0.5MG to 8MG) in accordance with AWWA D-100, as well as for preliminary geotechnical investigations.

Structural Engineer Tank Seismic Improvements | City of Burbank Water and Power, CA

Sridhar served as structural engineer for a comprehensive seismic, structural, corrosion, and safety assessment of 22 flat bottom steel tanks (18 potable water and four recycled water), ranging from 0.2 MG to 10 MG, performed on 14 different sites. The assessment included observation and inspection to record damage and document deficiencies, and then the development of recommendations for the seismic rehabilitation of the tanks. The City is in the process of implementing the recommendations of the corrosion study. Seismic deficiencies in 12 tanks were identified. Engineering services entailed cost evaluation for retrofit alternatives for the tanks, design of the retrofit, and construction administration support.

Project Manager Garfield Reservoir and Pump Station Replacement Project | City of South Pasadena, CA

Sridhar managed the preliminary design, final design, and engineering services during construction for replacement of the Garfield Reservoir and Pump Station and Administration Building. The site is in a residential neighborhood and the design required landscaping and noise analysis. The project also included a 6,000 SF



administration building and permanent treatment of site stormwater run-off prior to discharging to a flood control channel. Project features involve:

- Site specific ground motion analysis (site 100-feet away from active Raymond Fault Line)
- 2-3.5 MG partially buried cast-in-place concrete reservoirs
- 2,500-gallons-per-minute (GPM) booster station with two (2) 100-HP and one (1) 50-HP vertical turbine pumps with an on-site chlorination system including three chlorine metering pumps and multiple chlorine residual analyzers
- 6,000 SF two-story administration building with offices, shower/lockers, garage, conference room, and multi-purpose room

Project Engineer

Chevy Chase 968 Reservoir and Booster Pump Station | City of Glendale, CA

Sridhar served as the project engineer and structural design engineer during final design and construction of a 15 MG buried cast-in-place concrete reservoir underneath a golf course and a 2,400 GPM tri-level booster pump station in a residential neighborhood. During construction, Sridhar managed the office services provided, including attending weekly progress meetings and structural observation.

Design Manager

North Interceptor Sewer Project | City of Bend, OR

The North Interceptor Sewer Project (NISP) consists of the design and construction of a sewer transmission pipeline to accommodate the City's growth plans and policies, incorporate redundancy into the system, and replace aging infrastructure. Project features include:

- System Alternative Analysis: evaluating pump station wet well configuration, pump configurations, pipeline hydraulics and material, operational and maintenance considerations, and capital and life cycle costs
- 37 MGD (expandable to 74 MGD) pump station at WRF
- Six (6) major utility crossings. including open trench crossing across the North Unit Irrigation District (NUID) canal under Bureau of Reclamation jurisdiction, and trenchless crossings under Central Oregon Irrigation District pipeline, Swalley Irrigation District Pipeline, BNSF Railroad, Hwy 97 (ODOT), and Hwy 20 (ODOT)
- 10,500 LF of 54-inch pipeline, 17,000 LF of 30-inch pipeline, and 9,500 LF of 12-inch to 24-inch pipelines
- Vortex drop structure
- Easement acquisitions

Project Manager

Lift Station 1 and Emergency Storage

Reservoirs | Rainbow Municipal Water District | Rainbow, CA

Sridhar managed the planning and design of two lift stations (3,000 GPM and 700 GPM), one mile of 14-inch diameter force main, and two miles of 24-inch diameter gravity transmission main. The project also included two below grade, cast-in-place concrete emergency storage reservoirs (0.5 MG and 0.25 MG).

Project Manager

Morro Tank Retrofit | Rainbow Municipal Water District | Rainbow, CA

The Morro Tank is the lone source of storage in one of Rainbow Municipal Water District's (RMWD) water distribution system pressure zones. A structural and geotechnical analysis of the tank discovered the tank sits on unstable soil, which would require significant investment to rectify. Sridhar managed a hydraulic analysis to determine alternative means of providing storage and pumping facilities for the pressure zone.

Structural Engineer

Water Supply Stabilization Program | Antelope Valley-East kern Water Agency | Palmdale, OR

The WSSP2 is a groundwater basin banking project that will increase the reliability of the Antelope Valley Region's water supplies through construction of the necessary infrastructure to store excess water available from the State Water Project (SWP) during wet periods and recover and serve it to customers during dry and high demand periods or during a disruption in deliveries from the SWP. Sridhar was responsible for the structural design of the two 4 MG welded steel reservoirs and a single story masonry operations building.



Kevin Tirado, PE

Design-Build & Construction Observation Services



Qualified: BSCE - University of California, Davis

Connected: State of California Registered Professional Civil Engineer No. C72958 (Issued: July 2008, Expires December 2020); California State Water Resources Control Board T2 Water Treatment Operator No. 32230; California State Water Resources Control Board Grade D2 Water Distribution Operator No. 38693; American Water Works Association; WaterReuse Association; Southwest Membrane Operator Association

Years with GHD: < 1 yr | **Home Office Location:** Long Beach, CA

Professional Summary: Kevin is committed to streamlining processes and procedures to ensure maximum cost-effectiveness and efficiency. Dedicated professional who builds lasting, productive relationships with leaders of public organizations, private entities, and stakeholders. Technically skilled leader who brings a depth of engineering knowledge to complex business challenges and communicates effectively with "white collar" leadership and "blue collar" teams. Motivational coach and mentor who empowers employees to outperform expectations.

Project Manager

Black & Veatch | Los Angeles, CA | 2019-2020

Led business development initiatives in Los Angeles and surrounding areas. Led proposal teams pursuing regional water, wastewater, recycled water treatment plant upgrade projects. Collaborated with project team and disciplines to develop project approach, proposed scope of services, engineering cost estimates, and understanding of projects for regional project proposals.

Project Manager

Black & Veatch | Asset Inventory Project | Coachella Valley Water District | Coachella, CA | 2019-2020

Ensured scope, schedule, and budget are maintained for \$4M project budget for CVWD's asset inventory project. Regularly monitored project progress and budget. Coordinated with finance to department for timely submission of monthly project invoices.

Engineering Manager

SUEZ – North America | West Basin Municipal Water District | El Segundo, CA | 2015-2019

Lead engineering resource that provided technical support and services for the 40 MGD+ Edward C. Little Water Recycling Facility, 1 pump station, and 3 satellite treatment plants. Directed Engineering/Process Optimization team to perform process engineering work and provided process control expertise supporting plant operation. Focused on optimum plant performance of ozone, MF, RO, UV, clarifiers, filters, and solids handling systems by continuous review and assessment of plant operating data from field data collection reports, SCADA, and process control data management systems to ensure compliance with water quality objectives. Coordinated management of the District's CIP program, internal small-scale capital improvements, research and development studies, red-lining, asset management program assistance, and EH&S engineering support. Assisted

District personnel with project scoping documentation, RFPs, consultant panel interviews, review of design plans and specifications, construction meetings, and operational coordination during construction activities. Developed and reviewed monthly sales reports, energy usage, billing reports and strategized with District management to review project financial and water quality reporting to identify cost savings measures.

Facility Supervisor

Ocean Water Desalination Demonstration | West Basin Municipal Water District | Redondo Beach, CA | 2012-2014

Directed all operational and maintenance activities at the 0.5 MGD Ocean Water Desalination Demonstration Facility. Collaborated with District, engineering consultant, laboratory, contractor, vendor, and regulatory personnel to ensure the completion of research and data acquisition needed for the permitting, design, construction, and operation of a full-scale treatment facility. Responsible for the successful 24/7 continuous operation of the facility through consistent monitoring, assessment, and evaluation of plant performance while ensuring water quality compliance. Completed operational activities such as UF and RO cleanings, equipment troubleshooting, and implemented intensive data collection/analysis, equipment inspections, and water quality compliance sampling activities to evaluate pretreatment disc filtration, UF, and RO equipment.

Project Engineer/O&M Specialist

SUEZ – North America | West Basin Municipal Water District | El Segundo, CA | 2003-2012

Worked closely with District teams, engineering consultants, contractors, vendors, manufacturers, refinery, and regulatory agency staff to address, improve, and resolve plant process issues. Provided guidance to O&M teams and revised process control SOPs to address changing water quality and plant conditions. As the capital



Kevin Tirado, PE

improvement projects engineering liaison, collaborated with District, engineering consultant, contractor, and vendors for the design, construction and completion of capital improvement projects ranging from \$500K - \$20M including new chlorination system, membrane cleaning system modifications, water storage tank rehabilitation, dechlorination systems, pump station expansion, plant expansions, and biological aeration filter rehabilitation projects. Directed numerous MF and RO pilot studies and contributed to seawater desalination, media filter, and membrane qualification pilot studies including startup commissioning, system equipment operation and maintenance, water quality sampling, demonstration testing, and decommissioning activities. Spearheaded MF and RO membrane management program to track prolonged useful life and necessary warranty replacements for 15,000+ membranes. Utilized and evaluated manufacturer test data, load/unload, membrane repair, membrane backwash, cleaning data logs, and raw and normalized data to establish operational baseline and performance metrics. Contributing member of Asset Management program initiative group, corporate Front Line Leadership group, and served as project Health & Safety Committee Chair.

Design Engineer

CDM Smith | Aquifer Storage and Recovery Project | Calleguas Municipal Water District | Thousand Oaks, CA | 2002 - 2003

Lead design resource responsible for the design and construction oversight of the Las Posas Feeder Unit 3, a 3.5 mile long, 72-inch diameter bi-directional water pipeline. Completed design/hydraulic calculations, located utility conflicts, established pipeline alignments and profiles, located and sized system appurtenances, assisted with permit completion, developed engineering cost estimate, and reviewed contractor submittals and shop drawings during construction phase.

Environmental Project Manager

CDM Smith | New School and Modular Addition Environmental Site Assessment | Los Angeles Unified School District | Los Angeles, CA | 2001 - 2002

As part of the District's Environmental Management Program, coordinated with District staff, environmental consultants, regulatory agencies, and stakeholders to address environmental issues for proposed new school and modular additions. Managed multiple Phase 1 environmental site assessment and preliminary endangerment assessments for proposed construction projects. Developed and tracked project schedules, monitored project budgets, facilitated public hearings, and coordinated with environmental teams to ensure CEQA compliance.

Field Coordinator

CDM Smith | Cerro Grande Fire Cleanup | County of Los Alamos | Los Alamos, NM | 2001 - 2001

Post-disaster recovery debris removal joint effort with Los Alamos County and FEMA. Coordinated staff scheduling for monitoring stations for contractor debris removal oversight. Conducted post-debris removal site walks and interviews with property owners.

Project Engineer

CDM Smith | Carlsbad, CA | 1996 - 2000

Contributed to multiple projects including but not limited to projects for Calleguas Municipal Water District, Los Angeles Unified School District, Orange County Sanitation District, California Department of Transportation, City of San Juan Capistrano, City of San Diego, Los Alamos County (New Mexico), US Navy (San Diego), US Marines (Oceanside), and Los Angeles World Airports.



Nick M. Alvaro

Drone Survey

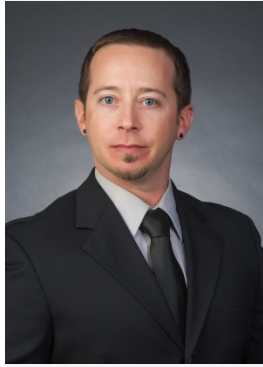

Qualified: B.S., Environmental Science, 2003

Connected: Industrial Environmental Association (IEA); San Diego Environmental Professionals (SDEP)

Years with GHD: 7 | Home Office Location: Irvine

Professional Summary: Nick has over thirteen years of professional experience working within the environmental industry with a primary focus on investigation and assessment, health & safety, compliance, and case management. His project experience includes Phase I and II site assessments, environmental compliance reviews, permitting, contractor oversight, site conceptual modeling, agency coordination, field project planning and execution, health & safety audits, and full cycle project management. He has worked at a variety of facilities and completed various projects impacted by a multiple contaminants including petroleum hydrocarbons, chlorinated solvents, pesticides, and heavy metals.

Field Geologist Reclaimed Water Conveyance United States Marine Corps | Camp Pendleton Oceanside, California | 2017

Performed soil logging and installation of multiple groundwater monitoring wells to a depth of 200 feet below ground surface per San Diego County Department of Environmental Health, Land and Water Quality Division, and Monitoring Well Program specifications and permit. Work included coordination with base officials and monitors for biological and cultural concerns.

Phase I ESA Assessor Various Clients | Southern California | 2010 - Current

Responsible for conducting site inspections per ASTM regulatory standards in order to complete Phase I environmental site assessments and transaction screens for a variety of clients. Extensive experience in completing historical desktop research, database reviews, and final report preparation. Over 50 assessments completed at facilities that include:

- Carpet manufacturing facilities in Southern California
- Auto dealership facilities in Southern California
- Aerospace supply distribution center in Torrance, CA
- Steel manufacturing plant in Adelanto, CA
- Warehouse facility in Redlands, CA
- Nursing home facilities in Orange County, CA
- Farm equipment manufacturing in Holtville, CA
- Soil hauling facilities in Southern California
- Electric motor repair facility in Colton, CA

CA Prop 65 Review and Guidance Gibraltar Industries, Inc. | Buffalo, NY | 2018

Assisted with CA Proposition 65 compliance evaluations for client's full product inventory. Responsibilities included

chemical classification, analytical testing, and label identification to meet state requirements.

Stormwater Pollution Prevention Plan (SWPPP) Barnes & Thornburg LLP | Southern California 2018

Prepared site-specific SWPPPs for multiple automotive customization facilities. Responsibilities included site inspections, document and compliance reviews, recommendations of best management practices (BMPs) and/or protocol improvements to meet No Exposure Certification (NEC), and full SWPPP document preparation.

Stormwater Pollution Prevention Plan (SWPPP) Water Replenishment District of Southern California | Pico Rivera | 2018

Assisted with third-party review of the site's draft SWPPP. Provided recommendations and updates to document in order to meet state requirements and ensure facility compliance.

Spill Prevention, Control, and Countermeasure (SPCC) Plans | Shell Oil | Southern California | 2017

Assisted with the preparation of SPCCs at multiple oil refineries and bulk distribution facilities. Responsible for secondary containment calculations, inventory reviews, and full document preparations.

EHS Support | Saint Gobain | Southern California | 2018

Conducted in-facility EHS support for two window film manufacturing facilities. Responsibilities included conducting routine compliance inspections for hazardous waste and permitting requirements, lead safety briefings, observed facility personnel and identify unsafe behavior trends/procedures, support incident and near miss investigations, and provide employee mentoring.



Noise Assessment | Inland Empire Utility Agency | Ontario | 2018

Completed site evaluation of various facility operations that require ear protection during use. Targeted areas were monitored and modeled to provide recommendations to client on proper health & safety requirements and procedures.

Environmental Scientist

Various Projects | Shell Oil US and Exxon Mobil Southern California | 2005 – 2016

Completed over 50 investigation and assessment projects at various retail gasoline service stations. Projects include soil boring drilling and sampling, groundwater well installation and destruction, groundwater monitoring, soil vapor probe installation and sampling, and remedial feasibility testing/extraction events. Responsibilities included the oversight of multiple subcontractors, vendors, and field staff simultaneously while keeping project goals on track and within budget. Continual focus on identifying unsafe trends and provided positive correction actions that lead to safe behavior and injury free work environments.

Project Coordinator

Soil and Groundwater Investigation | Ashford, Inc | Costa Mesa, California | 2016 - ongoing

Assisted with site strategy development in order to assess historical impacts to soil and groundwater from previous retail service station. Project activities to date include an extensive land and geophysical survey due to complex site features to adequately assess former UST features, Phase II ESA, groundwater monitoring well installation, and routine groundwater sampling. Additional responsibilities have included municipal file reviews, site characterization, coordination of fieldwork, and preparation of technical documents.

Project Coordinator

Phase II ESA | Brithinee Electric | Colton, California | 2018

Developed and completed Phase II ESA to adequately assess potential impacts from current and former site operations, as identified through a Phase I ESA. Project activities included a geophysical survey to identify a former UST cavity, and the drilling and sampling of ten soil borings.

Environmental Technician

Groundwater Assessment | Daytom Enterprises Santa Ana, California | 2016 -2017

Performed groundwater monitoring activities and oversight of subcontractors for volatile organic compound (VOC) impacted site. Assisted with pre-drilling activities for additional phases of soil/groundwater assessment and remedial feasibility testing.

GC/MS Technician

Laboratory Analysis | Irvine, California | November 2004 – August 2005

Prepared and analyzed soil, groundwater, and air environmental samples. Responsible for evaluating analytical data and quality control parameters.

UAV Data Collection

FAA-certified unmanned aerial vehicle (UAV) pilot for commercial applications. Responsible for conducting all aspects of commercial UAV operations, including pre-flight evaluation, safety review, piloting various UAV aircraft, and post-flight data evaluations. UAV services offered include videography, photography, topographic mapping, orthomosaic imagery, and emergency response. Recently completed projects include:

- Communications tower in San Bernardino, CA
- Street restoration projects in Southern California
- Stormwater retention basin in Pico Rivera, CA
- Water treatment facility in Anaheim, CA
- Active mining facility in Corona, CA

Other related areas of interest

Recognized (Certifications/Trainings)

- OSHA 40-hour Hazardous Waste Operations and Emergency Response (HAZWOPER)
- RCRA Hazardous Management / DOT Hazardous Materials Shipping
- Transportation Work Identification Credential (TWIC)
- eRailSafe System Badge
- American Heart Association First Aid CPR AED
- Federal Aviation Administration (FAA) Part 107 Certification (small UAS)



Francisco Andrade, SE, PE

Structural Engineer



Qualified: Bachelor of Science, Civil Engineering (BSc/2007); Master of Science, Structural Engineering (MEngSc/2013); Structural Engineer: CA #6345; Civil Engineer: CA #76742

Connected: Member of American Society of Civil Engineers, Structural Engineers Association of Southern California, American Concrete Institute, American Institute of Steel Construction

PE Civil CA (Issued: July 16, 2010; Expiration Date: December 31, 2020)

PE Structural CA (Issued: June 14, 2016; Expiration Date: December 31, 2020)

Years with GHD: 1 | Home Office Location: Irvine

Professional Summary: Francisco has over 10 years of experience in civil and structural design, engineering, and project management for numerous complex projects and the ability to professionally and effectively interact with clients, contractors and other professionals.

Knowledgeable in planning, code design standards, and construction inspection. Responsible

for supervising, overseeing and coordinating lead project engineers and designers. Engineer of record and engineer in charge for multiple national and international projects.

Lead Engineer

Pier A West | Tidelands | Port of LA, CA

Lead engineer responsible for the design and coordination of a 35 acre industrial development project that included: regrading of entire site, a new drainage system to collect storm water and pump it out to adjacent channel, and new office buildings on deep pile foundations. In addition, performed Structural Observations during construction phase and provided support to facilitate construction and reduce cost

Engineer in charge of structural design of:

- 40 feet long x 35 feet wide x 30 feet deep below grade concrete retention/treatment basin
- Catch basins and manholes of different sizes and depths
- Deep Pile foundation system for buildings
- Energy dissipater structure at drainage system outlet
- Additional responsibilities
 - Review of underground utility lines for compliance with traffic loads
 - Specifications for Prefabricated Office Building
 - Shop drawings review
 - Coordination between disciplines such as: mechanical, civil, and electrical

Lead Engineer

Valero Terminal | Valero | Fontana, CA

Lead engineer responsible for the design of a new fuel terminal. Scope consisted of the design of Pier/Mat type foundations for electrical, mechanical, and prefabricated metal buildings for structural support and to mitigate static and dynamic settlements due to on site soils, steel canopies for the support of piping systems and retaining walls. Structural support was also provided during the construction phase of the project

Engineer in charge of structural design of:

- Pier and mat foundations for electrical and mechanical equipment.
- Pier foundation system for prefabricated metal buildings
- Steel canopies and foundations for piping systems support for loading and offloading of fuel tank semi-trailers
- Retaining walls
- Additional responsibilities
 - Shop drawings review
 - Coordination with mechanical and electrical engineers
 - Specifications for Prefabricated Metal Buildings

Project/Design Engineer

Downey Promenade | Architects Orange | Downey, CA

Structural engineer in charge for the design of a segment of the multi acre development for a new commercial/retail plaza in the City of Downey. Responsible for the design of new buildings, architectural features, electrical and mechanical equipment supports and foundations, and retaining walls. In addition, responsible for providing structural support during the construction phase of the project

Engineer in charge of structural design of:

- Concrete Masonry (CMU) buildings with roof Panelized Systems and Roof Steel Joist System
- Wood Building
- Buildings' Foundations
- Architectural Features
- Retaining walls
- Electrical and mechanical equipment supports and foundations
- Additional responsibilities
 - Shop drawings review



- Coordination with mechanical and electrical engineers, and contractors
- Structural Observations/Inspections during construction phase
- Structural RFI Responses

Lead Engineer

Medical Building | Trapani | Roseville, CA

Structural engineer responsible for the design of a new medical office building for radiation treatment. The building's framing design consisted of concrete bearing walls with a concrete roof, and thickened concrete sections of the building to act as a radiation barrier. The project scope also included the design of foundations and structural supports for vibrations sensitive medical equipment.

Engineer in charge of structural design of:

- Building's concrete bearing/shear wall system for vertical gravity loads support and lateral force resistance
- Building's concrete roof for vertical gravity loads support and as a rigid diaphragms
- Foundations and structural support for vibrations sensitive medical equipment
- Additional responsibilities
 - Coordination between disciplines such as: architect, mechanical engineer, electrical engineer
 - Material Specifications

Engineer of Record

BP Cherry Palm Springs Terminal | British Petroleum | Palm Springs, CA

Civil/Structural Engineer of record for a new Oil facility terminal. Scope of project included: regrading of the site including an earthen secondary spill containment system for above ground storage tanks, new drainage system, new office buildings, and new loading and offloading terminal areas

Engineer in charge of structural design of:

- Foundations for above and below ground storage tanks
- Multiple office buildings' foundations
- Steel racks and bridges for piping systems
- Mechanical, electrical, and piping equipment foundations and supports
- Retaining walls to divert floodwater due to site being located in flood zone area
- Additional responsibilities
 - Coordination between disciplines such as: mechanical, civil, and electrical
 - Materials Specifications

Lead Engineer

New Steel Building for Commercial Use | PK Architecture | Indio, CA

Structural engineer in charge for the design of a new steel building for commercial use. The building's framing design consisted of steel moment and braced frames with curtain walls, and a steel beams/joist roof system with metal deck. Structural support was also provided during the construction phase of the project.

Engineer in charge of structural design of:

- Building's structural framing system, which included moment and braced frames
- Building's structural roof system
- Additional responsibilities
 - Shop drawings review
 - Structural RFI Responses
 - Coordination between disciplines such as: architectural, mechanical, civil, and electrical

Other areas of expertise

- Structural design for new construction, retrofit, and alterations to existing hot rolled steel, cold formed steel, concrete, masonry and wood single and multi-story buildings and structures
- Structural field surveys and assessment reports of existing buildings and structures
- Seismic retrofit
- Structural design of supports for electrical, mechanical, and architectural components in mid-rise building
- Development of structural specifications and cost estimates

Other Affiliations

- Tau Beta Pi Engineering Honor Society
- Chi Epsilon Civil Engineering Honor Society



Erel Betser, PE

Fire Protection



Qualified: M.S. Fire Protection Engineering, 2010, Worcester Polytechnic Institute, B.S. Mechanical Engineering, 1999, Tel-Aviv University

Connected: Licensed Professional Engineer - Fire Protection Engineering (FPE) (CA - FP1880), Licensed Professional Engineer - Mechanical Engineering (ME) (CA - ME37116)
Member, Group I-3 (Institutional) Occupancy Code Development Task Force, California State Fire Marshal (CSFM), 2017-2018

SFFD Approved 3rd Party Smoke Control Reviewer

President, Northern California Nevada (NCN) Chapter, Society of Fire Protection Engineers (SFPE), 2014-2016

Member – SFPE, NFPA, ICC East Bay Chapter

PE Fire Protection CA (Issued: January 27, 2015; Expiration Date: June 30, 2021)

PE Mechanical CA (Issued: June 27, 2014; Expiration Date: September 30, 2020)

PE Mechanical and Fire Protection DE (Expiration Date: September 30, 2020)

Years with GHD: 3 | Home Office Location: Emeryville

Professional Summary: With over 18 years of experience, Erel has successfully managed teams and supervised complex fire protection engineering projects specializing in identifying critical project issues and implementing innovative solutions. Erel brings a unique blend of building and fire code consulting including fire protection/alarm systems design, egress plans, engineering judgements, alternate means and methods, smoke control design and commissioning, fire modeling and performance based design with services ranging from the early stages of design to final construction period. Erel has worked on several Court Buildings and is has a good record track with design approvals at the Office of the California State Fire Marshal.

Project Manager/Senior FPE Former Fort Ord Ground Water Treatment Plant | Marina, CA

Project Manager responsible for providing fire protection engineering design services to the new groundwater cleanup operations plant. Services included planning sessions, hydrant flow tests, detailed fire sprinkler design, approval by U.S. Army Corps of Engineers, review of water supply options, and response to RFIs.

Project Manager/Senior FPE Port of San Francisco | San Francisco, CA

Project Manager/Senior Fire Protection Engineer responsible for providing fire protection engineering and code consulting services to the Port of San Francisco. Services included design of fire sprinkler and standpipe systems for Pier 19, Pier 23, Pier 28, Pier 33, and Pier 50 development of code approach letters for multiple piers based on occupancy types and space usage, and presentations to Port officials and Fire Marshal.

Project Manager/Senior Consultant San Francisco International Airport (SFO) Terminal 3 West Renovation | San Francisco, CA

Project Manager/Senior Consultant responsible for providing fire protection engineering and code consulting services for the \$500 Million, design-build, project scheduled to be completed in 2022. Services includes leading code meetings during planning phase, delivering Fire Protection/Life Safety Code Approach reports and

egress plans for the different phases/stages, construction support for enabling projects, site surveys to review and assess existing conditions, and developing and presenting to the BICE and SFFD.

Project Manager Santa Clara County Valley Medical Center (SCCVMC) | San Jose, CA

Project Manager responsible for providing fire protection engineering and code consulting services for a 574 bed hospital. Services included on-going engineering and consulting services, fire protection systems design, fire alarm design reviews, life safety surveys, discussions with Office of Statewide Health Planning and Development (OSHPD) and Santa Clara County Fire Marshal, testing and commission, and preparation of life safety plans.

Project Manager/Senior FPE California Franchise Tax Board Campus | Sacramento, CA

Project Manager/Senior Fire Protection Engineer responsible for providing fire protection engineering services for the Fire Sprinkler and Fire alarm Systems upgrades as part of the California Department of General Services (DGS) Facilities Management Division (FMD) Deferred Maintenance Construction Program. Services include: Assessment of existing fire alarm systems and network, design of new fire alarm network and workstations, assessing sprinkler deficiencies, developing design documents, cost estimate, and providing construction administration services.



**Project Manager/Senior FPE
Elihu M. Harris State Building | Oakland, CA**

Project Manager/Senior Fire Protection Engineer responsible for performing fire protection systems due diligence survey and recommendation as part of the California Department of General Services (DGS) Facilities Maintenance Division (FMS) Deferred Maintenance construction Program. Provides fire protection engineering and code consulting services for the 22-story, high-rise, building. Services include: Fire Protection systems assessment, sprinkler coverage and protection, fire pump room evaluation, and developing and presenting to the Authority Having Jurisdiction (CSFM).

**Project Manager/Senior Consultant
San Francisco International Airport (SFO)
Terminal 1 Redevelopment | San Francisco, CA**

Project Manager/Senior Consultant responsible for providing fire protection engineering and code consulting services for the \$2.4 Billion, design-build, project scheduled to be completed in 2024. Services included leading code meetings, delivering Fire Protection/Life Safety Code Approach reports and egress plans for the different phases/stages, construction support for enabling projects, site surveys to review and assess existing conditions, and developing and presenting to the local Authority Having Jurisdiction (BICE and SFFD) creative solutions to address existing non-conforming conditions.

**Project Manager/Senior FPE
Shasta County, New Redding Courthouse |
Redding, CA**

Project Manager/Senior Fire Protection Engineer responsible for providing fire protection engineering and code consulting services for the new 165,000 SF, high-rise, courthouse building consist of 14 courtrooms. Services provided from the Schematic Design Phase through Bidding and included design of fire sprinkler and fire alarm systems, smoke control analysis and design, egress plans, building and fire codes analysis report, drawing review, developing alternate means and methods and presentations to the California State Fire Marshal (CSFM).

**Senior FPE
Operational Readiness Training Complex | Fort
Hunter Liggett, CA**

Senior Fire Protection Engineer responsible for providing fire protection review and design of fire sprinkler systems at the new complex that will consist of three barracks to accommodate over 800 soldiers, a battalion headquarters building, a company headquarters building, dining facility and vehicle maintenance facility. Services included detailed fire sprinkler design, approval by U.S. Army Corps of Engineers, and review of water supply options.

**Project Manager/Senior FPE
Alameda County, East County Hall of Justice |
Dublin, CA**

Project Manager/Senior Consultant responsible for providing fire protection engineering and code consulting services for a new 146,000 SF complex which includes a courthouse tower and county office building. Services included building and fire codes analysis report, smoke control design for windowless portion of the building (Central holding), drawing review, Engineering Judgements preparation and reviews, developing alternate means and methods and presentations to the State of California Fire Marshal.

**Project Manager/Senior Consultant
New Yolo County Courthouse | Woodland, CA**

Project Manager/Senior Fire Protection Engineer responsible for providing fire protection engineering and code consulting services for the new 163,000 SF building comprised of 14 courtrooms and 415 parking spaces. Services included building and fire codes analysis report, fire modeling and performance based design approach for Central holding facility and accessibility consulting services.

**Senior Fire Protection Engineer
California Pacific Medical Center, Cathedral
Hill hospital | San Francisco, CA**

Fire Protection Engineer responsible for providing fire protection consulting services for a new 700,000 SF hospital. Services included the development of a fire protection code approach to allow the placement of oil fuel at the basement level of the hospital, this approach was presented and approved by OSHPD.

**Project Manager/Senior FPE
University of California Davis Chemistry and
Chemistry Annex Buildings Safety
Improvements | Davis, CA**

Project Manager/Senior Fire Protection Engineer responsible for providing fire protection design and code consulting services for the two existing chemistry department, non-sprinklered, buildings. Services included the design of new fire protection systems (sprinkler, standpipe, fire pump), reviewed of existing conditions, and developed plans for the installation of sprinkler system in existing building.

**Project Manager/Senior FPE
Stanford, McMurtry Building for the Arts |
Stanford, CA**

Project Manager/Senior Fire Protection Engineer responsible for providing fire protection engineering code consulting services for the new 96,000 SF interdisciplinary hub for the arts. Services included drawing reviews, code approach reports, developing alternate means and methods of construction request, review of design details and preparation of engineering judgements.



Devin Brady

CAD/BIMM



Qualified: A.S Computer Aided Drafting

Professional Summary: Senior CAD designer proficient in Civil 3D, InfraWorks, ReCap and the other various Autodesk products for Infrastructure projects. Always looking to expand knowledge and experience in new and rising technologies, innovative alternative design approaches. I'm outgoing and enthusiastic person who loves troubleshooting and enjoy new and challenging projects.

Design Coordinator & BIM Management **Rialto Bioenergy Facility | Anaergia | Rialto, CA**

Devin advises engineer & drafter with all designs of the project along with doing clash detection between the different disciplines on the project through the design build process. Coordinated drafter packages for permitting on the project.



Michael Chapman

Blue Ribbon Panal / Conventional Treatment



Qualified: Bachelor of Science, Monash University, 1974, Bachelor of Chemical Engineering, RMIT, 1985

Connected: Water Research Association – Scientific Advisory Committee. Australian Water Recycling centre of Excellence – Industry Representative, National Protocol Development Committee (Recycled Water Treatment Processes). Author ‘Water Treatment Plant Design’ (2012) AWWA/ASCE- Ch. 9; High rate granular media filtration

Years with GHD: 23 | Home Office Location: Melbourne, Australia

Professional Summary: Mike is a Chemical Engineer of 39 years’ experience in the water industry. He is a water treatment and water supply specialist and has extensive experience in new water & recycled treatment design, review / upgrade of treatment plants, risk assessment and pilot plant studies. He previously was the Global Leader for Water Treatment and Desalination Service Line, which means he was the Australian and international technical leader for this area for GHD. He was also previously Manager for Water Quality and Asset

Management for all water treatment facilities operated by Melbourne Water..

Process Design Lead City of Anaheim | USA | 2015

Lead for pilot plant work and full scale testing of 11no different coagulant options (e.g. PAC, polymers, ferric salts) and revision of existing treatment process to uprate this 56ML/d plant to 76ML/d. the existing process train is coagulation/lamella plate clarification/ozonation/deep bed gravity filters. Testing for filtration speeds up to 20m/hr with alternative coagulant was successful (2015)

Process Design Lead North Pine WTP SEQWater | Qld | 2016

Detailed Process design for addition of a new washwater management and sludge dewatering system at 250MLD WTP. Included lamella plate thickeners, jet mixed sludge tank and 2 no centrifuges for dewatering up to 18 tonnes dry sludge per day. Work included revisions to concept design, Process Flow Diagram, P&IDs design criteria table and equipment data sheets and review of suppliers submissions (2016).

Process Design lead Charters Towers Regional Council | Qld | 2016

Upgrade options for existing clarifier/filtration plant (18MLD) to achieve >22MLD capacity, including hydraulic, process and general arrangement options and cost estimation. (2016).

Process design Jar Testing Hamilton City Council | NZ | 2016

Comprehensive week long jar testing to assess future coagulation/flocculation/settling treatment chemical options for a 40MLD augmentation of the existing 110MLD Waiora clarifier/filtration WTP. (2016).

Process Design Lead Coliban Water | Vic | 2016

Comprehensive week long jar testing to assess future coagulation/flocculation/settling treatment chemical options for a 40MLD augmentation of the existing 110MLD Waiora clarifier/filtration WTP. (2016).

Process Design Lead Coliban Water | Vic | 2015

Review of 14No exiting water treatment plants operated by CW for a future water treatment strategy assessing what upgrade works are needed for the next 25 years including replacement with pipelines. WTP processes reviewed include DAFF, Clarification/filtration, Ozone/GAC and MIEX for plant capacities ranging from 0.5ML/d to 35ML/d (2015).

Design Lead Automation of East bank and West Bank WTPs SEQWater | Qld | 2015

Risk assessment and gap analysis for the 650MLD clarification/filtration plant and the 250MLD clarification/DAF/filtration plant that together supply the bulk of treated water to Brisbane. Automation works and implementation strategy/priorities were developed based on shifting from 24hr per day site attendance down to 8 to 12 hour per day site attendance (2015).

Design Lead SEQWater | Qld | 2014

Concept design for Upgrade/automation works for conversion of existing Conventional East Bank WTP (680MLD) and sedimentation/DAFF West Bank WTP (250MLD) from 24hr (3 shift) attendance to 1 shift attendance including process audit, risk assessment and improvement works program (2014).



**Design Lead
Townsville RC | Qld | 2014**

Completion of quantitative Cryptosporidium risk modelling for Ross River dam and then assessment of log removal capability of the associated Douglas WTP (232MLD) followed by concept design of 100MLD capacity new lamella plate clarifier plus 232MLD UV disinfection treatment barriers to achieve required log removal requirements (2014).

**WTP Design Lead
Dadu WTP | Pakistan | 2013-2014**

Design Lead for process, hydraulic, control philosophy and layout concept for a turbidity, hardness removal then brackish water desalination WTP (98MLD) for Pakistan Water & Power Development Authority. The treatment process included React water clarifiers, Fluidized Bed Pellet Reactors (hardness removal), Gravity Filtration then Reverse Osmosis and associated chemical systems. The project is currently being tendered for a Design & Construct Contract (2013/14).

**Jar Testing and Process Designer
Western Water | VIC | 2013-2014**

Full scale and jar test work evaluation and then process design including P&IDs, control philosophy and equipment data sheets for D&C contract for Powdered Activated Carbon, prelime and fluoride dosing upgrade for Rosslynne WTP(35MLD DAFF process) for manganese oxidation, THM control and fluoridation (2012) and follow up advice during commissioning (2013/14).

**Process Design Lead
Cairns Regional Council | QLD | 2013-2014**

40MLD Mulgrave Aquifer WTP Process Design Lead for aeration, manganese/iron oxidation and DAFF or MF treatment including treatment process definition and siting/hydraulic assessment leading to future Early Contractor Involvement and development in a detailed D&C contract (2010)

Drinking Water stabilization strategy for Cairns Region at 13No water supply source points to minimize high/low pH and corrosion risks (2010).

**Process Design Lead
SEQ Water | QLD | 2009-2010**

Joint Pilot plant program development with Hunter Water, then ongoing adjustment of pilot plant program and then review of results for Process Design Lead for Concept and detail design for 180MLD Wyaralong WTP consisting of softening using Reactivators, dual media filtration, Ozone/BAC, UV and chlorination then chloramination for Brisbane water supply (2009/2010).

**Project Manager & Process Designer
Townsville City Council | QLD | 2002-2009**

Townsville Water Quality Improvement Project (2002/09)
Project Manager for concept design for Townsville City

Council and then later completing successful GHD detail work in BOOT project (with Trility and Brookfield-Multiplex). Work included water quality risks, water quality standards, pilot plant study for direct filtration treatment process, all aspects of concept and then detail design (process, hydraulics, layout and controls) for now operational new 40 ML/d WTP (Ultrafiltration/ chlorination process upgradeable to 60ML/d) and upgrade work for the existing 232ML/d conventional and direct filtration processes at Douglas WTP.

**Process Designer
Coffs Harbour Water | NSW | 2007-2009**

Water Quality risk assessment, treatment plant process design and detailed hydraulic, layout, equipment sizing and commissioning work for the Coffs Harbour WTP (56ML/d DAFF/UV). The filters are designed for future GAC retrofit and plant is designed for, and has operated in, both Direct Filtration and DAFF mode. Process includes manganese removal by pot permanganate oxidation (2007/09).



Ulysses Fandino, PE

Plant Piping

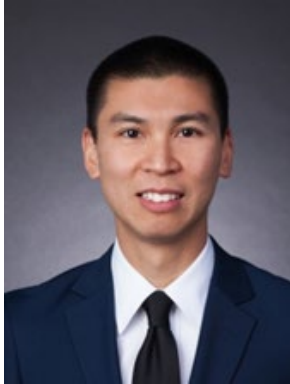

Qualified: MS in Civil Engineering, California State University, Long Beach; BS in Civil Engineering, California State Polytechnic University, Pomona;

Connected: Professional Civil Engineer State of California CA/C64558
PE Civil CA (Issued: January 23, 2003; Expiration Date: June 30, 2021)

Years with GHD: 4 | Home Office Location: Irvine

Professional Summary: Ulysses Fandino is a civil engineer more than 20 years of total experience as project manager and project engineer in planning, design, and construction of sanitary sewer and water pipeline projects. His expertise also includes master planning and condition assessment for gravity sewers and storm drains, design of potable water pipelines, trenchless design of sanitary sewers via bore-and-jack and pilot-tube microtunneling, sanitary sewer rehabilitation, potholing utilities, and permitting.

Project Manager
Otay 1st & 2nd Pipelines West of Highland Avenue | City of San Diego Public Works Department | San Diego, CA | 2015-Current

This water transmission pipeline replacement project for the City of San Diego replaces 5 miles of 16-inch through 42-inch water transmission pipelines and approximately 2.3 miles of 8-inch through 12-inch water distribution mains. The project includes a new PRV station and a new control valve station at the University Heights Reservoir. The project also includes Caltrans permitting for three (3) trenchless 60-inch tunnel crossings of the I-805 freeway. The project will overlay streets with new AC pavement, replace approximately 140 new ADA curb ramps and upgrade accessible parking along several neighborhood streets. The construction is scheduled to begin in 2018.

Project Manager
30th Street Pipeline | San Diego, CA | 2015-2017

This project includes the replacement over 5.8 miles of 24-inch through 42-inch transmission mains and 8-inch through 16-inch distribution mains. Tasks for the project include development of technical pipe specifications and pipe design calculations.

Project Manager
Master Plan of Sanitary Sewers for the West Anaheim Area 2015 | City of Anaheim Public Works Department | Anaheim, CA | 2015-Current

Prepare the master plan update for the West Anaheim Area sewer systems. The project involves wet weather flow monitoring, using H2O Map hydraulic modeling and ArcGIS software to identify sewer lines requiring rehabilitation and/or replacement, preparing cost estimates for sewer lines needing improvements for the existing and build-out land use conditions, and determining the financial plan for obtaining the funding sources on building the proposed sewer improvements.

Project Manager
Newport Coast Sewer Lift Station Rehabilitation Project | Irvine Ranch Water District, Newport Beach, CA | 2015-Current

Serve as the Design Manager for the complete rehabilitation design of a 500-gpm regional sewer lift station that includes the recoating of the wet well, new CIPP lining for the 12-inch DIP sewer force, new wet well washer system, and sewer bypass pumping during the wet well and dry well rehabilitation. The dry well rehabilitation involves a new innovative discharge header that doubles back on itself, a new 30-foot deep underground stairwell for improved ingress/egress to the dry well, and improved ventilation. The project also includes constructing a new CMU block electrical building with new PLC and MCC equipment, and a new chemical odor control system.

Project Manager
San Diego Programmatic Wastewater Pipeline Condition Assessment Project | San Diego, CA | 2015-Current

Provide technical writing services for the preparation of reports for twenty-three gravity and force main sewer facilities as part of the San Diego Programmatic Wastewater Pipeline Condition Assessment project led by Tran Consulting Engineers. The reports include discussion of CCTV, geotechnical, corrosion, hydraulic, groove inspection and physical inspection activities.

Design Manager
City of Culver City | Culver City, CA | 2015-Current

Tunneling design of a series of new trunk sewers to consolidate up to 5 local sewer pumping stations into a single regional facility. This resulted in the design of approximately 11,500 lineal feet of new 8-inch to 15-inch trunk sewers. To mitigate impacts to/from shallow groundwater, private properties, Caltrans rights-of-way, and traffic approximately 4,500 lineal feet of trunk sewers were installed via microtunneling construction methods.



Project Manager
Alamitos Barrier Improvement Project, Orange County Water District | Seal Beach, CA | 2013-2014

Managed the preparation of engineering design reports, plans, specifications, and cost estimate for the wellhead installation of 17 new injection wells and 4 new monitoring wells along the Los Alamitos Channel in Seal Beach to augment injection capacity along the north-south reach of the Alamitos Barrier. Other design elements include design of 24-foot high temporary noise barriers (sound walls), phasing and planning of well construction activities, and well telemetry/SCADA design coordinated with Orange County Flood Control District and Los Angeles County Department of Public Works.

Project Engineer
Truckee River Interceptor Rehabilitation, Tahoe-Truckee Sanitation Agency | Truckee, CA | 2014

Completed the design plans, specifications, and engineer's construction cost estimate for the CIPP trenchless rehabilitation of 1,250 LF of 24-inch RCP and DIP sanitary sewer. Tasks include alternatives analysis, rehabilitation design, bypass design, environmental review and permitting. The project alignment passed under the Truckee River twice, through a private condominium complex, and along a heavily traveled recreational bike trail.

Project Manager
Water System Replacement Design Project, Air Force Civil Engineering Center (AFCEC) | Pillar Point Air Force Station (AFS), CA | 2012-2013

Completed the design plans, specifications, and construction cost estimate for the replacement of the existing 3-inch potable water system at Pillar Point AFS. The replacement design included a comprehensive Basis of Design report, hydraulic modeling, surveying, geotechnical analysis, a new booster pump station, and coordination for sensitive habitat and archeological areas. and existing condition infrastructure evaluations.

Project Manager
35% Preliminary Design Water System Replacement Phase 1 North | Air Force Civil Engineering Center (AFCEC) Vandenberg Air Force Base (VAFB), CA | 2012-2013

Completed the preliminary design plans, specifications, and construction cost estimate for approximately 65,000 linear feet of new HDPE potable waterlines at North VAFB. The preliminary design included a comprehensive Basis of Design report, extensive hydraulic modeling analysis, trenchless design under the existing UPRR railroad, and coordination for underground explosive ordnance and sensitive habitat areas.

Project Manager
Fire Protection System Deficiency Study for Canon Air Defense Complex (CADC) Naval Facilities Engineering Command (NAVFAC) SW | Marine Corps Air Station (MCAS) Yuma, AZ | 2012-2013

Conducted a study to determine the deficiencies of fire flow supply within the existing water distribution system. The fire protection study included valve and fire hydrant testing, and leak detection testing via acoustic listening devices. The existing MCAS Yuma GIS database was updated to develop improvements to the current water system to meet fire flow demand. The final report of the study will recommend solutions to improve the deficiencies with engineering cost estimates according to the Department of Defense estimating standards.

Project Engineer
Citywide Sanitary Sewers Improvement Program (CSSIPP) Groups 1 through 5 | City of Anaheim, Public Works Department | Anaheim, CA | 2006-2011

Completed the final design plans, specifications and engineer's construction cost estimates for 11 separate design packages of replacement 10- to 27-inch vitrified clay pipe (VCP) gravity sewers within the City of Anaheim. The design of replacement sewers included analysis of alternative alignments, implementing trenchless technology (microtunneling and bore-and-jack methods), new right-of-way acquisition, and positioning new sewers close to existing utilities.

Project Engineer
Combined West Anaheim Area Master Plan of Sanitary Sewers and Combined Central Anaheim Area Master Plan of Sanitary Sewers | City of Anaheim Public Work Department | Anaheim, CA | 2001-2006

Prepared the final master plans for the Combined West Anaheim Area and Combined Central Anaheim Area sewer systems. Utilized Hydra modeling software to identify sewer lines requiring rehabilitation and/or replacement. Prepared cost estimates for sewer lines needing improvements for the existing and build-out land use conditions. Assisted in preparing the financial plan for obtaining the funding sources on building the sewer improvements.



Duncan Findlay, JD

Legal



Qualified: Juris Doctorate, Willamette University, 1973; Bachelor of Arts, Political Science, University of Washington, 1969

Admitted to Practice: Supreme Court of the State of Washington, United States Federal District Courts of Eastern and Western Washington.

Washington State Bar Association (Issued: October 18, 1973)

Years with GHD: 11 | Home Office Location: Phoenix

Connected: Washington State Bar Association American Council of Engineering Companies (ACEC), Phoenix Rotary 100, Co-Chair, Engineering Firms Sector, King County United Way Campaign, 2001 Campaign Year.

Career History

- General Counsel, GHD Inc. (present)
- Chief Operating Officer, PB Telecom, Inc. (2004-2007)
- Vice President, Professional Service Industries, Inc. (2002-2004)
- Partner, Lane Powell Spears Lubersky, LLP (2001-2002)
- Board of Directors, Shannon & Wilson, Inc. (1994-2002)
- President, Seattle Branch Manager, General Counsel, Western Region Director, Director of Human Resources and Director of Risk Management, Shannon & Wilson, Inc. (1994 - 2001)
- President, Tewell & Findlay, Inc. P.S. (1989 - 1994)
- Board of Directors, Cascade Testing Laboratory, Inc. (1984-2002)
- Managing Partner, Tewell & Findlay, Inc. P.S. (1980 - 1994)
- Partner, Loucks & Lamb (1973 - 1978)

Contract Negotiation Experience

- Systemwide Agreement for on-call engineering services with the Union Pacific Railroad. Annual aggregate fee NTE \$1M.
- Systemwide Agreement for on-call engineering services with the Southern Pacific Transportation System. Annual aggregate fee NTE \$1M.
- Systemwide Agreement for on-call engineering services with the Burlington Northern Railroad. No aggregate annual fee limit.
- Subconsultant Agreement with URS Consultants for remedial planning activities at uncontrolled hazardous substances disposal sites in EPA Regions IX and X.

- Subconsultant Agreement with URS Consultants for program management and technical environmental services in support of the Navy's Environmental Engineering Program at activities under the cognizance of Western Division, Naval Facilities Engineering Command (Navy CLEAN). \$9 to 10M over ten years.
- Agreement with Consolidated Rail Corporation (Conrail) for design engineering services for clearance improvements at seven Pennsylvania Tunnels. Approximately \$1M.
- Subconsultant Agreement with Sverdrup Corporation for Washington State Department of Transportation for a design report and access plan for S.R. 509 east-west corridor. >\$5M.
- Agreement with the Washington State Convention and Trade Center for the conversion and expansion project to provide geotechnical design and inspection services.
- Agreement with Sound Transit for Geotechnical Investigation for Link Light Rail tunnel, Seattle, Washington (\$7M).
- Agreement with Southeast Corridor Constructors for geotechnical support for certain sectors of I-25 (T-REX) improvements, Denver, Colorado.
- Agreement with Battelle Memorial Institute for low-level radioactive waste disposal site characterization studies for the Geff and Martinsville, Illinois sites (1989). \$3 to \$4M in services over 2 1/2 years.
- A/E subcontract with PB/MK for geotechnical investigation and design services for the Superconducting Super Collider Project, Ellis County, Texas (1991). \$1.5M.



- Subcontract with Gannett Fleming for geotechnical investigation and design services related to the Boston Central Artery (I-90) Project. The total project scope exceeds \$15 billion.

Design/Build Projects

- DM&E Railroad, Wyoming (Kiewit)
- Virginia Avenue Tunnel, Wn. D.C. (Kiewit)
- Whittier Access Tunnel, Whittier Alaska (VECO)
- I-25 S.E. Corridor, Denver, Colo. (SECC)
- Tacoma Narrows Bridge, Gig Harbor, WA (TNC)
- Seattle Monorail Project

Speaking Engagements & Publications:

- Electronic Signatures – Implications for the Design Professional, ASFE, Boston, Massachusetts (April 2001)
- Limitation of Third Party Liability, ASFE, Boston, Massachusetts (April 2001)
- Contract Negotiation—Case Histories, ASFE, Tucson, Arizona (October 2000)
- Marketing Materials Liability, ASFE (April 2000)
- “Toxic Mold, The Fungus Among Us Goes to Court,” Summer 2002 Edition of “Environs, Recent Developments in Environmental Law”, Lane Powell Spears Lubersky, LLP
- Contributing Author, Washington State Chapter, ABA Deskbook on the Design/Build laws, 2002 revised edition
- Contributing colleague, “The Care and Feeding of Individual Consultants and Their Clients,” Dunncliff and Parker, Geotechnical News, June and September issues, 2003
- Co-Editor, “State-by-State Guide to Construction Contracts and Claims”, Aspen Publishers, Inc. 2006



Michael Freid

Cost Estimating

Qualified (Education): ASU Center for Environmental Studies, Hazardous Materials Handling, 1992; California State University, Water Treatment Plant Operation, 1992; Rio Salado College, Management and Productivity, 1989; Phoenix College, Undergraduate Studies, 1979; Associated General Contractors of America (AGC) Supervisory and Project Management.

Years with GHD: 20 | Home Office Location: Phoenix

Professional Summary: Mike Freid has been with GHD since 1999 and offers more than 30 years of local construction experience. He specializes in cost estimating, constructability review, construction inspection, dispute resolution, and contract negotiations and management of water and wastewater related projects. Mike's background includes providing construction and commissioning services for water and wastewater treatment facilities, water mains, water supply/storage, well pumps, booster pumps, sewer lift stations, reinforced concrete structures, steel fabrication, and installation of large and small diameter collection and distribution pipeline projects.

**Senior Construction Project Manager
Evergreen Well | Global Water Resources |
Buckeye, AZ | 2012**

Well site construction, including installation of a well pump, pipe, valves, controls, and site improvements at a potable water well site. Mike oversaw the construction while monitoring schedule, costs, and quality. He also helped secure project funding through the American Recovery and Reinvestment Act of 2009 (ARRA).

**Senior Construction Project Manager
Frank Lloyd Wright Arsenic Treatment System |
Frank Lloyd Wright Foundation | Scottsdale, AZ
| 2013**

Mike managed a design/build well head Arsenic treatment system for Taliesin West, Frank Lloyd Wright's Scottsdale, Arizona architectural school and museum. He provided constructability review during design, provided value engineering, managed site construction, startup, and commissioning. Mike also helped the client achieve drinking water compliance with the Maricopa County Department of Health Services.

**Senior Construction Project Manager
34th Street Groundwater Treatment System |
Freescale Semiconductor | Phoenix, AZ | 2013**

Mike was responsible for the design/build of a groundwater treatment system. He provided constructability review during the design phase and managed plant construction, including staffing, vendor procurement, scheduling, planning, and cost tracking to assist the client with contamination containment.

**Senior Construction Project Manager
Ruth Fisher Tank and Well | Saddle Mountain
Unified School District | Tolleson, AZ | 2015**

Saddle Mountain Unified School District in Tonopah, Arizona needed to replace its existing potable well and water storage tank at the Ruth Fisher Elementary School.

Mike was responsible for all construction-related activities; staffing, quality control, subcontractor selection and oversight, scheduling, planning, and cost tracking. He provided high quality system installation and integration with the existing distribution system. Water quality of the new well resulted in a substantial reduction in operating costs of the existing electro dialysis reversal (EDR) water treatment system.

**Senior Construction Project Manager
Casa Grande Water System Rehab | City of
Casa Grande | Maricopa, AZ | 2011**

The City of Casa Grande is located approximately 50 miles southeast of Phoenix, Arizona. The City entertained open bidding for the rehabilitation of its hydro-pneumatic distribution system. The project award was based on an alternative system proposal created by a Senior Construction Project Manager. Mike was responsible for the management of tank, pipe, pump, and programmable logic controller (PLC) panel installation along with integration, subcontractor selection and management, scheduling, planning, cost tracking and startup and commissioning.

**Senior Construction Project Manager
Buckeye Ranch Arsenic Treatment System |
Global Water Resources | Maricopa County, AZ
| 2011**

This was a Design/Build project. Mike provided constructability review during the design phase and provided value engineering. He was responsible for management of construction activities, the installation of equipment, staffing, planning, cost tracking, system commissioning and start up.

**Senior Construction Project Manager
Sweetwater Well Site Arsenic Treatment**



**System | Global Water Resources |
Buckeye, AZ | 2007**

On this Design/Build project, Mike provided constructability review during the design phase, provided value engineering, was responsible for management of construction activities; the installation of equipment, staffing, planning, cost tracking, system commissioning and start up.

**Senior Construction Project Manager
Sonoran Vista Well Site Arsenic Treatment
System | Global Water Resources |
Buckeye, AZ | 2008**

During this Design/Build project, Mike provided constructability review during design phase, provided value engineering, was responsible for management of construction activities, the installation of equipment, staffing, planning, cost tracking, system commissioning and start up.

**Sr. Construction Project Manager
Well Site Sodium Hypochlorite Disinfection
Systems | Global Water Resources |
Buckeye, AZ | 2007**

Mike was responsible for the design, construction startup, and commissioning of 17 disinfection systems at 17 separate locations for a major potable water provider in the greater Phoenix metropolitan area to replace problematic existing systems.

- Sweetwater 2
- 7th and Alarcon
- 4th and Baseline
- Blue Hills
- Rancho Vista
- Dixie Well Site
- Sun Valley
- Hacienda Ares
- Garden City
- Roseview
- West Phoenix 1
- West Phoenix 6
- West Phoenix 7
- Bulfer Primrose
- Buckeye Ranch
- Sonoran Ridge
- Sunshine

**Senior Construction Project Manager
Apache Lift Station | City of Mesa | Mesa, AZ**

Mike's responsibilities with this project included the rehabilitation of a large multi-pump sewage lift station comprised of the increase in overall height and volume, new interior lining, and inter-connective pump piping for this City of Mesa site project.

**Senior Construction Project Manager
IBWC Wastewater Treatment Plant
Rehabilitation | International Boundary Water
Commission | Rio Rico, AZ | 2003**

The International Boundary Water Commission (IBWC) sought to complete a traveling bridge sand filter rehabilitation. The facility provides sewage treatment primarily for the city of Nogales, Arizona, and its sister city, Nogales, Mexico. The scope of work for this project included the rehabilitation of five traveling bridge sand filters.

- Removal of existing treatment media (650 tons).
- Removal of Original Equipment Manufacturer (OEM) media support system (7,520 square feet).
- Removal of 15 existing pumps and related piping.
- Repairs to existing fiberglass cell dividers.
- Modifications to existing skimmer hoods.
- Value Engineering and installation of a US Filter Gravisand™ system.

In addition to completing the work in a timely manner, Mike received the highest possible rating (A) on the contractor performance review by the IBWC's Contracting Officer Representative (COR).

Other related areas of interest

Recognized (Certifications/Trainings)

- Arizona Class 1 Wastewater Treatment Plant Operator
- Arizona Class 1 Water Treatment Plant Operator
- Eljen Wastewater Treatment Systems Installer
- 8 Hour Arizona Mine Safety and Health Administration Refresher, 2013
- 24 Hour Arizona Mine Safety and Health Administration, 2011



Jeff Knauer, PE, ME, NACE CP Specialist

Corrosion/Material



Qualified: M.S. Mechanical Engineering, University of California, San Diego; B.S. Mechanical Engineering, University of California, Los Angeles

Connected: Subject Matter Expert for Civil Engineering – California Board of Professional Engineers; Chapter Board of Directors (2008-2010) – Concrete Repair Institute, Northern California; NACE Institute International Certification Review Committee (2015-present); National Association of Corrosion Engineers; Bay Area Water Works Association; San Francisco Post Officer (2016-present) - Society of American Military Engineers.

PE Mechanical CA (Issued: January 25, 2002; Expiration Date: June 30, 2020)

PE Civil CA (Issued: June 24, 2005; Expiration Date: September 30, 2021)

PE Civil HI (Issued: July 30, 2013; Expiration Date: April 30, 2020)

PE Civil WA (Issued: November 21, 2013; Expiration Date: March 12, 2020)

NACE CP Specialist (Issued June 9, 2000)

Years with GHD: 3 | Home Office Location: Emeryville

Professional Summary: Mr. Knauer has extensive experience with corrosion risk assessment and mitigation design for conveyance and distribution pipelines, pump stations, storage facilities and various water related infrastructure; marine and offshore structures; and oil and natural gas storage and conveyance systems. Mr. Knauer has designed numerous cathodic protection systems and has been involved as the corrosion engineer and corrosion engineering design team leader for municipal and federal marine projects throughout the Western United States and the Pacific Islands. Mr. Knauer is licensed in civil engineering (CA, HI, WA), mechanical engineering (CA, WA) and is a NACE certified Cathodic Protection Specialist. Mr. Knauer has experience with design of corrosion control solutions in challenging environments and is an accomplished task leader for large scale corrosion assessment and rehabilitation projects and provides expert witness services.

**Senior Corrosion Engineer
Carlsbad Desalination Plant Shut Down
Assessments | Poseidon Water | Carlsbad, CA,
USA**

Senior Corrosion Engineer for the cathodic protection system assessments for systems installed on plant infrastructure as a part of the first annual plant shut down.

**Project Principal
Stray Current Corrosion Investigation and
Mitigation Design | Cal Water Services | San
Mateo, CA, USA**

Project Principal for analysis of potential stray current interference between a proposed pipeline installation/existing cathodic protection systems and design of stray current corrosion mitigation measures.

**Program Manager
Benicia Wastewater Treatment Plant | City of
Benicia | Benicia, CA, USA**

Program Manager to develop various cathodic protection design alternatives for the City of Benicia's Waste Water Treatment Plant Plant-Wide Corrosion Upgrade project.

**Program Manager
Santa Clara Water Pollution Control Plant | City
of San Jose | San Jose, CA, USA**

Program Manager for multi-year corrosion engineering services and design contract to assess, maintain and upgrade corrosion control infrastructure.

**Program Manager
As-Needed Corrosion Engineering Services |
San Francisco Public Utilities Commission |
San Francisco, CA, USA**

Program Manager for a 3-year 1M as-needed corrosion engineering contract encompassing services including field survey and cathodic protection design.

**Program Manager
Davis Wastewater Treatment Plant | City of
Davis | Davis, CA, USA**

Cathodic protection and corrosion control design for infrastructure associated with major treatment plant expansion.

**Project Engineer
Water Treatment Plant Improvements | East
Bay Municipal Utility District | Oakland, CA,
USA**

Project Engineer for Claremont Tunnel Outage, Sobrante, San Pablo and Upper San Leandro Water Treatment Plant improvements.

**Program Manager
Campus-Wide Utility Fitness for Service
Evaluation | Hitachi Global Systems
Technology | San Jose, CA, USA**

Program Manager for a campus wide-utility infrastructure Fitness for Service Evaluation to assess the risk of



corrosion related failure and recommend corrosion mitigation alternatives.

**Lead Corrosion Engineer
Campus-Wide Utility Fitness for Service
Evaluation | Lawrence Berkeley National
Laboratory | Berkeley, CA, USA**

Lead Corrosion Engineer for a campus wide-utility infrastructure Fitness for Service Evaluation to assess the risk of corrosion related failure and design of impressed current cathodic protection systems for corrosion control of utility piping.

**Corrosion Control Design Team Leader
P1-102 Plant 1 Upgrade Project | Orange
County Sanitation District | Fountain Valley,
CA, USA**

Corrosion Control Design Team Leader for Orange County Sanitation District as part of 170M Secondary Activated Sludge Facility 2 at Plant No. 1 Project.

**Corrosion Engineer
Trinity River Pump Station | Coastal Water
Authority | Houston, TX, USA**

Corrosion Engineer for the Trinity River Pump Station corrosion control assessment and cathodic protection design for pump station intake piping and associated structures including agency coordination and assistance during construction.

**Corrosion Engineer/Design Manager
Southside Transmission Main Phases 4, 4A,
and 5 | City of Corpus Christi | Corpus Christi,
TX, USA**

Corrosion Engineer and Corrosion Design Manager for Southside Transmission Main Phases 4, 4A, and 5 corrosion control investigation, cathodic protection system design, protective coating recommendations and technical assistance during construction and for several miles of large diameter water transmission main in the immediate vicinity of the Gulf of Mexico.

**Corrosion Engineer
Water Storage Tank Design | Dublin San
Ramon Services District | Dublin, CA, USA**

Corrosion Engineer responsible for impressed current and galvanic cathodic protection system design for various potable and recycled water storage tanks.

Other related areas of interest

Registrations CA Civil, C68329. CA Mechanical, M31977. HI Civil, 15589. WA Mechanical, 50938. WA Civil, 50938. NACE CP Specialist, Cert. No. 9181.

Presentations

- NACE International Corrosion Risk Conference "Fitness for Continued Service: A Risk Management Approach to Assessing Corrosion and Prioritizing Infrastructure Improvements" Houston, TX, May 2016.
- NACE DOD Corrosion Conference, "The Critical Role of Consistent Facilities-Wide Corrosion Control Design Criteria and O&M Practices to Facilities Asset and Risk Management", La Quinta, CA, August 2011.
- NACE Western Area Conference, "Corrosion of Reinforced Concrete Structures in the San Francisco Bay", October 2008.
- AWWA Annual Conference, "The Critical Role of Consistent Corrosion Control Criteria as Part of Comprehensive Asset and Risk Management Planning" Poster Presentation, San Diego, CA, June 2009.
- AWWA Distribution Systems Symposium, "The Critical Role of Consistent Distribution System Wide Corrosion Control Criteria as Part of Comprehensive Asset and Risk Management Planning" Poster Presentation, Reno, NV, September 2009.
- CWEA Annual Conference "Corrosion Control and Cathodic Protection" Santa Clara, CA, April 2014.
- Nevada Rural Water Association "Corrosion Control and Cathodic Protection Fundamentals" Reno, NV, March 2014
- AWWA Cal-Nevada Fall Conference "Corrosion and Corrosion Control Fundamentals" Sacramento, CA, October 2013.
- AWWA Annual Conference "Corrosion Control and Cathodic Protection for Water Conveyance, Storage and Treatment Facilities" Las Vegas, NV, August 2013.
- NACE Western Area Conference, "Corrosion of Reinforced Concrete Structures in the San Francisco Bay" San Francisco, CA, November 2012.
- AWWA Cal-Nevada Spring Conference "Fitness for Continued Service: A Risk Management Approach to Assessing Corrosion and Prioritizing Infrastructure Improvements" Sacramento, CA, March 2016.
- NACE Western Area Conference, "Delamination Rate Analysis of Reinforced Concrete Structures in Marine Environments", December 2016.



Ryan Kristensen, PE

Resident Engineer - Mechanical



Education: MS, Civil Engineering – Hydrology and Water Resources Engineering, University of California, Los Angeles, 2013; BS, Earth and Environmental Engineering, Columbia University, 2012; BA Management-Engineering, Claremont McKenna College, 2010

Professional Registration: Professional Civil Engineer – CA – C85173, Qualified Stormwater Pollution Prevention Plan Developer (QSD)

PE Civil CA (Issued: December 20, 2015; Expiration Date: March 31, 2020)

Years with GHD: 2 | Home Office Location: Long Beach

Professional Qualifications: Mr. Kristensen has served as a project engineer on feasibility assessments and conceptual studies, facility master plans and capital improvement programs, preliminary and final design drawings, engineering services during construction, and has obtained compliance with regulations and permitting requirements. Through his involvement in rehabilitation and improvement projects, Mr. Kristensen has developed experience tracking assets, performing condition assessments, and focusing improvement efforts to maximize the benefits of capital improvement programs. As Project Engineer for the 3A Water Reclamation Plant Improvements, Mr. Kristensen's initial efforts will categorize areas of improvement across the plant. The focus will be to package improvements based on construction sequencing that will minimize disruption to the plant's operations. Mr. Kristensen will serve as the point person for technical expertise across GHD and will engage specialists as necessary. Mr. Kristensen is available for co-location to support MNWD staff with the development of Requests for Proposals for each improvement package and will be involved in daily discussions and decisions at Plant 3A.

Project Engineer Lenain WTP Expansion and Rehabilitation | Anaheim Public Utilities Department | Anaheim, CA

Serving as Project Engineer for the Design of Rehabilitation and Expansion at the Lenain Water Treatment Plant. GHD developed a comprehensive Facility Master Plan including cost and schedule for the replacement and rehabilitation (R & R) of facilities as well as expansion of the LWTP from 15 to 20-22 mgd. Performed treatment optimization studies and optimization including Jar testing of various coagulants and hydraulic assessments of plant and distribution system. GHD established the Asset Management framework for the City of Anaheim and is implementing the framework at LWTP. Performed detailed facility condition assessments at the plant and consequence analyses. The project includes significant pipe treated water pipe modifications to allow the delivery of the additional treated capacity into the distribution system.

Completed the preliminary and final designs for the selected improvements and assisted in bidding and Contractor selection. The proposed improvements at LWTP are recommended to maintain Regulatory Compliance and Safety, Water Quality, Plant Reliability, and Flexibility for Plant Expansion. Currently providing engineering services during construction and specialty inspection/resident engineering and startup/commissioning services. Construction is scheduled to be completed by end of 2019. Existing influent and effluent pipelines at LWTP will be upsized from 24" to 36" and will be co-located in the LWTP Secondary Access Road. This new location of the influent and effluent pipelines will increase accessibility for

maintenance. Additionally, the Secondary Access Road will be widened to facilitate the flow of vehicles at LWTP. It is anticipated that the cost of the Secondary Access Road improvements will be partially offset by the plan to install new Influent and Effluent pipelines in the road.

Select electrical equipment at LWTP and Walnut Canyon Reservoir will be upgraded to comply with current standards. To increase reliability, a temporary electricity generator that has been in operation since 2004 will be replaced with a permanent backup generator. Two (2) Electrical Vehicle Charging Stations will be constructed to support the City's goal to make it easier to recharge electric vehicles throughout the City.

Project Engineer Engineering Design Guidelines | Inland Empire Utilities Agency | Chino, CA

Serving as project engineer for the development of the Engineering Design Guidelines. The Engineering Design Guidelines communicate design preferences of the Inland Empire Utilities Agency (IEUA) to its consulting engineers/designers to improve consistency and efficiency of project deliveries. Significant workshops and staff interactions were utilized to build consensus regarding Guidelines format.

The Guidelines were developed in tabulated forms to improve their read and ease of future modifications and/or additions. The level of completeness and usefulness of these Guidelines will improve with their use and updates. The level of details included in the Guidelines was targeted to the 30-percent design level. The tabulated format will be helpful to incorporate into Preliminary Design/Basis of Design documents. The level of details/requirements were developed with emphasis on



technical areas that are common sources of inconsistencies during designs. Currently updating the Guidelines and adding new technical sections and coordinating its content with the IEUA Front End Contract Documents that have been recently updated by GHD. The updated Guidelines are scheduled for publication in late 2018.

Project Engineer, Carbon Canyon Water Recycling Facility Asset Management and Improvements Package III | Inland Empire Utilities Agency | Chino, CA

Serving as Project Engineer for the CCWRF Asset Management and Improvements Project. IEUA launched three (3) CCWRF Asset Management and Improvement packages in order to improve a number of processes at CCWRF based on input from Operations, Maintenance, Engineering, O&M Documents, and Asset Management Plans. GHD is providing design services for Package III of Asset Management and Improvements at CCWRF. GHD is completing the detailed design for the following improvements: Replace Leaky Influent and Effluent Tertiary Filter Weirs; New Flocculation Basin Overflow Weir; Demolish Abandoned Chlorine Disinfection System; Replace Filter LCP with a new PLC and integrate to SCADA; Refurbish Corroded Monorails; Refurbish and/or Replace Filter Backwash Troughs; Refurbish or Replace Cast Iron Tertiary Filter Gates; Extend Concrete Lining at the Emergency Storage Lagoon; New Flow Meters at the CCB; Increase Reliability of Plant Utility Water System; Replace Drain Valves and Plug Valves at CCB and Tertiary Filters.

**Project Engineer
Cryogenic Facility Condition Assessment | Los Angeles Bureau of Sanitation | Los Angeles, CA**

Served as a project engineer for the condition assessment of cryogenic facilities at the Los Angeles Bureau of Sanitation's Hyperion Water Treatment Plant (HWTP). This project included assessments of the structural condition of cryogenic facilities and identified the process upgrades required to maintain safe and reliable operations at the HWTP. Recommendations generated as an outcome of this project provide a basis for Capital Improvement Projects set to occur the HWTP.

**Project Engineer
American Honda Motor Company Recycled Water Retrofit | West Basin MWD | Torrance, CA**

Provided engineering services during construction for the recycled water retrofit project at the American Honda Motor Company campus in Torrance, CA. The project consisted of converting portions of the 101 acre campus to serve recycled water for irrigation purposes. Developed a plan for Division of Drinking Water (formerly CDPH) cross-connection testing at the campus for minimal impact to routine operations. Prepared record drawings for West

Basin Municipal Water District and the American Honda Motor Company.

**Project Engineer
Weymouth and Jensen Water Treatment Plant Solar Facilities | Metropolitan Water District of Southern California | Los Angeles, CA**

Developed civil design drawings for the Metropolitan Water District of Southern California's Weymouth and Jensen Treatment Plant Solar facilities, filed the LADWP Solar Incentive Program Reservation Request and Solar-Powered Customer Generation Interconnection Agreement for a 1MW solar facility at the Jensen Treatment Plant. Completed the SCE California Solar Initiative Reservation Request, Exporting Generating Facility Interconnection Request, and Renewable Energy Self-Generation Bill Credit Transfer Interconnection Agreement for a solar facility at the Weymouth Treatment Plant. Provided engineering services during construction and reviewed and responded to RFI's and Shop Drawing submittals during the construction of the Weymouth Water Treatment Plant Solar Facility.

Other related areas of interest

Recognized (Certifications/Trainings)

- CA Professional Engineer – C85173
- Qualified Industrial Stormwater Practitioner (QISP)
- Envision Sustainability Professional (ENV SP)



Jonathan Linkus AICP, LEED-AP

LEED



Qualified: Bachelor of Architecture (BArch 2008), University of Southern California; Master of Architecture in Urban Design (MAUD 2011), Harvard University

Connected: American Institute of Certified Planners (AICP); LEED-Accredited Professional

Years with GHD: 1 | Home Office Location: Irvine

Professional Summary: Jonathan is an urban design + planning professional whose 8 years delivering public and private planning projects are based on thoughtful client and stakeholder relationships and integrated thinking across urban scales. Jonathan's role ranges from detail-oriented designer to managing large multi-disciplinary master planning efforts. His work pioneers innovative place-making and which have garnered 8 regional, state, and national planning awards as lead planner or PM. His project types include university campus LRDPs, mixed-use district and streetscape concepts, transit-oriented specific plans, living waterfronts with coastal resiliency, and airport-connected projects.

Lead Planner/Urban Designer
Canberra City Centre Transit Oriented Study |
City Renewal Authority | Canberra, ACT |
Current

Urban concept that integrates transit infrastructure and walkable mixed-use development to activate the heart of Canberra as a national crossroads. | 12 Ac. Study Area

Lead Planner/Urban Designer
Caesars East-Side Live/Work/Play Master Plan |
Caesar's Entertainment | Las Vegas, CA | 2018

Prepared district mixed-use and open space options that introduce a walkable living and workplace setting adjacent to the famed Strip.* | 3.46M GSF, 106 Ac. Study Area

Team Planner/Urban Designer
Vision 2045: Downtown Las Vegas Master Plan
| City of Las Vegas | Las Vegas, NV | 2015 -
2017

Prepared site plans for Symphony Park mixed-use residential and arts district, one of the eight transit-oriented hubs.* | 3.46M GSF, 106 Ac. Study Area

Team Planner/Urban Designer
Eau Claire West: Mixed-Use Urban Village |
GWL Realty Advisors | Calgary, AB | 2012

Multi-function open space proposals within a mixed-use hotel and residential project. Prepared yield summaries and solar impact studies.* | 2.0M GSF, 6.5 Ac. Study Area

Team Planner/Urban Designer
Dominion Bridge at Ramsay Exchange | New
Urban | Calgary, AB | 2011 - 2013

Site plan options and mixed-use development yield summaries. Architectural façade concepts, and outreach presentation graphics.* | 1.5M GSF, 18 Ac. Study Area

Lead Planner/Urban Designer
Bridgeville Community Center Vision |
Bridgeville CCC | Humboldt Co, CA | Current

Space needs analysis, public outreach events, building design, pricing, and conceptual site layout. | 3 Acres

Team Planner/Urban Designer
Australian War Memorial 50-Year Master Plan |
Australian War Memorial | Canberra, ACT |
2018

Proposed long-range adaptation scenarios in a memorial development framework with campus visioning. | 35 Acres

Lead Planner/Urban Designer
UHWO Long Range Development Plan |
University of Hawaii | Kapolei, HI | 2017 - 2018

Developed conceptual site plan options and preferred space need analysis, multi-day workshop, public outreach for Hawaii's fastest growing 4-year university.* | 500 Acres, 20k FTE Students

Co-Project Manager/Lead Planner
CSUSB Palm Desert Campus Major Master Plan
| CSUSB | Palm Desert, CA | 2015 - 2017

Directed a multi-disciplinary long range integrated master plan effort, developed plan concepts and outreach material for 4 workshops.* | 169 Acres, 8k FTE Students

Co-Project Manager/Lead Planner
CSUSB Major Master Plan | CSUSB | San
Bernardino, CA | 2015 - 2017

Directed a multi-disciplinary long range integrated master plan effort, developed plan concepts and outreach material for 6 workshops.* | 422 Acres, 25k FTE Students

Co-Project Manager/Lead Planner
CSUSB Major Master Plan | CSUSB | San
Bernardino, CA | 2015 - 2017

Directed a multi-disciplinary long range integrated master plan effort, developed plan concepts and outreach material for 6 workshops.* | 422 Acres, 25k FTE Students

Project Manager/Lead Planner
Amazon HQ2 Nevada | Las Vegas Economic
and Urban Development Department | Las
Vegas, NV | 2017 - 2018

City-sponsored conceptual design entry for new 50,000-employee Amazon headquarters across three downtown sites.* | 8.07M GSF, 70 Acres

*Work performed with previous employer



Lead Planner/Urban Designer

Embarcadero Center Redevelopment | Boston Properties | San Francisco, CA | 2013

Prepared interactive “urban patio” designs, public art, lighting, collaborative digital workstations.* | 56K GSF

Project Manager/Lead Planner

Peachtree Corners Innovation Hub Master Plan | City of Peachtree Corners | Peachtree Corners, GA | 2017

Developed two mixed-use gateway districts, prepared adaptive reuse/infill and transit framework as land use subconsultant.* | 8.27M GSF, 950 Ac. Study Area

Assistant Project Manager

Airport Compatible Land Reuse Strategy (ACLReP Phase 2) | City of Phoenix | Phoenix, AZ | 2017 - 2018

Prepared 9 subcontracts, fee-by-task breakdown, and accounting structure for \$5.5M planning fee. Project-winning interview participation.* | 2 mi² Study Area

Lead Planner

Ekurhuleni Aerotropolis Master Plan | Municipality of Ekurhuleni | Ekurhuleni, Gauteng | 2013 - 2015

Regional coordination strategy for airport-related industry sectors in 14 communities as land use subconsultant.* | 1,030 Ac. of Site Design, 760 mi² Study Area

Lead Planner

Burbank Airport B-6 Master Planning Study | Airport Authority | Burbank, CA | 2013 - 2014

Site planning with entitlement and Part-77 exhibits for mixed-use workplace and flex-industrial airport-connected development.* | 2.35M GSF, 60 Ac. Study Area

Lead Planner

Memphis Aerotropolis Airport City Master Plan | City HCD + Chamber | Memphis, TN | 2012 - 2014

Comprehensive Plan and district designs supporting key economic sectors, with significant public and stakeholder outreach participation.* | 10.89M GSF, 60 mi² Study Area

Certifications

- American Institute of Certified Planners (AICP) | American Planning Association | #30431
- Leadership in Energy and Environmental Design Accredited Professional (LEED-AP) | Green Business Certification Inc. (GBCI)

Awards

- Outstanding Initiative | Peachtree Corners Innovation Hub Master Plan | American Planning Association - GA Chapter | Sep 2018*
- Best Practices Award of Excellence | Mission Creek Sea Level Rise Adaptation Study | American Planning Association - CA Chapter | Sep 2017*
- Innovation in Green Community Planning Award of Excellence | Mission Creek Sea Level Rise Adaptation Study | American Planning Association – Northern CA Chapter | Jun 2017*
- Best Practices Merit Award | 2016 CSUSB Palm Desert Campus Master Plan | American Planning Association – Inland Empire Section | Apr 2017*
- (Awards Continued on Next Page)
- Urban Design Award | 2016 CSUSB Palm Desert Campus Master Plan | American Planning Association – Inland Empire Section | Apr 2017*
- National Planning Award 2016: Municipality Ekurhuleni Aerotropolis Master Plan | South Africa Planning Institute (SAPI) | Jul 2016*
- National Planning Award 2016: Professional Ekurhuleni Aerotropolis Master Plan | South Africa Planning Institute (SAPI) | Jul 2016*
- Outstanding Planning Award For a Plan | Memphis Aerotropolis Airport City Master Plan | American Planning Association – TN Chapter | Aug 2014*

*Work performed with previous employer



IAAM **IAAM**
 endorsed endorsed
 TRAINER ASSESSOR

Roop Lutchman, P.Eng, PMP

Asset Management



Qualified: MBA, 2003; MSc., 1987; B.Sc. (Hons), 1981

Connected: Registered Professional Engineering (P.Eng.) in Ontario; Project Management Professional (PMP), certified by the Project Management Institute; Member of the Water Environment Federation (WEF), Plant Engineering and Maintenance Association of Canada (PEMAC), and the American Society of Mechanical Engineers (ASME)

P.Eng (Issued: September 4, 1996; Expiration Date: September 30, 2020)

Years with GHD: 8 | Home Office Location: Mississauga

Professional Summary: Roop has 36 years of experience in various engineering industries, with 17 years of experience in business consulting. Focused on helping clients minimize business costs and a thought leader in the asset management (AM) field, Roop brings a global perspective to projects from his work with the Water Services Association of Australia on international AM benchmarking projects. Additionally, Roop has significant experience

across North America in the water/wastewater, public works, electric, and oil and gas industries. With his focus on strategy, assets, people, processes, and technology, Roop has successfully implemented many practical and effective business consulting solutions for clients.

Roop is a Principal and Global Leader for Asset Management based in GHD's Mississauga office. He has 36 years of combined management consulting and industry experience. A professional engineer and recognized industry expert in the management consulting field, Roop focuses on strategic planning, business optimization, asset management, organizational development, operations and maintenance, and the use of technology to enable business processes. He is the author of three books on these subjects, published by DESTech Publishers: *Computerized Work Management Systems for Utilities and Plant Operations* (2003), *Sustainable Asset Management* (2006), and *Creating and Managing Sustainable Organizations* (2011). He is an endorsed assessor and auditor for PAS55 asset management. Additionally, Roop is a member of the WEF Plant Operations and Maintenance and Utility Management Committees, member of the American Water Works Associations (AWWA), and former director of PEMAC.

AM Technical Lead

WRD Southern California | Ongoing Since 2015

Development of an asset management plan – gap analysis, develop AM roadmap, governance model and technology enablers consistent with ISO 55000 requirements. Also, includes piloting AM concepts, development of asset risk profiles and implementation of the AMS (Assetic) /CMMS (Cityworks) at the Leo Van de Lans Plant - ongoing.

AM Technical Lead

City of Anaheim | Ongoing Since 2015

Leading practices AM education, asset hierarchy and data attributes definition. Ongoing guidance on development of AM development consistent with ISO 55000 requirements. Also, includes development of asset risk profiles and lifecycle strategies and an O&M review (in line with

leading AM practices) of the Lenain Water Treatment plant.

AM Technical Lead

Western Municipal Water District | Ongoing Since 2015

Development of an asset management plan – gap analysis, develop AM roadmap, governance model and technology enablers consistent with ISO 55000 requirements. Also, includes review and update of the INFO EAM CMMS asset hierarchy and data attributes.

Project Manager/Risk Management Advisor

Water and Wastewater Linear Infrastructure | Metro Vancouver | Ongoing Since 2017

Development of a risk framework, risk profiles and risk mitigation plans for linear infrastructure. The approach is based on the on leading asset management practices, risk management methodology and ISO 31000 Risk Management Standard. We will be leveraging data from the GIS, CMMS and Hydraulic models systems for risk analysis. Lifecycle Management Strategies will be developed for a pilot asset class and this will be used to guide rollout of the overall risk program to the rest of the operations.

Project Manager/AM Strategic Advisor

Toronto Water AMS | Ongoing Since 2014

Development of an asset management solution, technology enablers (including SAP Plant Maintenance, Hansen and Avantis) and AM roadmap for Toronto consistent with ISO 55000 requirements. This project has kicked off in August 2014 work is currently in progress to achieve the project objectives. Project outcomes will be AM Roadmaps (W/WW – Vertical & Linear and Storm Water assets) based on a gap analysis using GHD's TEAMQF tool, and data management standards/software solutions to support AM decision making. The City is



employing a unique approach of an Industry scan of leading practices as well as engagement of a Peer review group of global municipalities in identifying relevant leading practices. An AM Governance Model has been developed to support implementation and sustenance at the City.

**Project Manager & Strategic Advisor
Asset Management Program | Region of York |
Ongoing Since 2014**

Development of an asset management solution for the Environmental Services Department to help improve capital planning and maintenance of the Region's aging infrastructure. Project outcomes are AM Roadmaps (WW – Vertical & Linear, Waste management and Green infrastructure assets together with a supporting AM governance model) based on a gap analysis using GHD's TEAMQF tool.

**Project Manager and Strategic Advisor
Asset Management Program | City of Ottawa |
Ongoing Since 2014**

Development of data, systems and asset knowledge as part of the City's ongoing AM development effort. This includes updating the asset data attributes, integration requirements, asset hierarchy, knowledge areas, and a development of a guide for assessing and implementing technology assets solutions. This assignment required a review of SAP Plant Maintenance, Maximo and RIVA Solutions. At the end of the project, the City will achieve consistency, in its data model, configured software systems to support its AM business processes, and the right information and knowledge to support AM related decision making.

**Project Manager/AM Strategic Advisor
Risk Management for Water, Wastewater
Linear Infrastructure | Region of Peel |
Ongoing Since 2011**

Development of a risk framework, risk profiles and risk mitigation plans for the Lake Based water Supply System based, Trunk Sewers, Collections and Distribution systems. The approach used is based on the on leading asset management practices and the AWWA RAMCAP risk methodology and ISO 31000 Risk Management Standard. Lifecycle Management Strategies are being developed for each asset class to mitigate high risk assets. Project also included an AM gap analysis based on a gap analysis using GHD's TEAMQF tool. Outcomes were a comprehensive risk profile and validate Capital program, AM roadmap and AMP for the transmission and sub-transmission mains. We leveraged data from the GIS, Hansen and Hydraulic models systems for risk analysis.

**Lead Asset Management Reviewer
Asset Management Benchmarking Program |
Water Services Association of Australia | 2012**

This program is done every 4 years on the behalf of the International Water Association. It covers the areas of:

corporate policy and business planning, asset acquisition, asset operation, asset maintenance/rehabilitation and business support systems. For the 2012 benchmarking initiative, forty global utility participants are currently enrolled and going through the benchmarking process. Roop is accredited in the use of Aquamark benchmarking software and as a lead reviewer, provide guidance to utilities in developing their maturity scores and improvement roadmaps. Roop also facilitated workshops at the leading practices conference helping Utilities share knowledge on key asset management areas.

**AM Strategic Advisor
Asset Management Program | Columbus
Department of Public Utilities | OH |
2009 – 2011**

Development and implementation of a utility wide (Water and Wastewater) asset management program aimed at helping the utility sustain service levels in a cost effective manner in the face of growth, deteriorating infrastructure and resource constraints. Phase 1 is focused on vision, development of AM philosophy/model, current situation analysis, LOS, organization redesign to support AM, training plan development, Oracle WAM CMMS support, AM education, AM roadmap and improvement Initiatives.

Other related areas of interest

Publications

- Lutchman, R., 2011, "*Creating and Managing Sustainable Organizations*", Book, DESTech Publishers Inc., ISBN: 978-1-932078-041-9
- Lutchman, R., 2006, "*Sustainable Asset Management*", Book, DESTech Publishers Inc., ISBN: 978-1-932078-47-9
- Lutchman, R., 2003, "*Computerized Work Management Systems for Utilities and Plant Operations*." Book, DESTech Publishers Inc., ISBN: 1-932078-30-4
- Lutchman, R, *Risk Managed*, Water Canada Magazine March 2014
- Lutchman, R., 2003, 2004, "*Asset Management, CMOM, GASB, What Does it All Mean?*" Communicator Magazine, 2 part series

Presentations

- Lutchman R, "Asset Management for Green Infrastructure" Ontario Coalition for Green Infrastructure, Pioneer Village, Ontario, 2016
- Lutchman R, "Asset Management Fundamentals for Decision makers" South Florida Chamber of Commerce , 2016



Mehdi Mardi, PE

Senior Electrical and I&C Lead



as instrumentation design.

Qualified: B.S. Electrical Engineering (Control & Power), Tehran Sharif University, IRAN February 1991; B.S. Applied Physics, Ferdowsi University, IRAN November 1988

Registrations: CA#C20033

PE Electrical CA (Issued: June 1, 2012; Expiration Date: September 30, 2020)

Years with GHD: 2 Home Office Location: Irvine

Professional Summary: Mehdi is a Professional electrical engineer with over 20 years of experience in the Electrical, Instrumentation and Control (I&C) fields in various type of industry like as Water and Waste Water, Oil & Gas, Petrochemical, Cryogenic and Industrial Gases. Mehdi has been involved in Electrical and I&C design, construction and commissioning on various projects including pump stations, desalination and water and wastewater treatment plants, Industrial Gas production, Hydro Power Generation, Land Field Gas, Oil and Gas field projects. He has experience in Medium and low voltage motor controls and distribution, as well

Anaheim – Lenain Water Treatment Plant | Anaheim, CA

This scope of project at this job site is to improve the plant reliability and water quality, increase the capacity and regulatory compliance. The electrical and instrumentation scope of work is detailed design and engineering related to replacement of the portable generator with a stationary generator, modify the existing switchboard and adding ATS, enhance the area lighting, HVAC and CCTV. Replacing some control panels and control valves and instruments, and integration into SCADA system.

Electrical Engineer Philadelphia Force Main Improvement | IEUA | San Bernardino, CA

This project scope of work is to modify the existing lift station and add VFD to the third pump and prepare the electrical and instrumentation packages. Make recommendations for improving the electrical design and operation. The project is still in progress.

Electrical Engineer Ground Water Recovery Improvement Program | Water Replenishment District | Pico Rivera, CA

The scope of project at this job site is to be the client's engineer for a Design-Build project. Review of the drawings and specifications during the design period, and during the construction to review contractor submittals for conformance with drawings and specifications and respond to RFIs and site visit are part of weekly task.

The project is in construction now and it is due to be commissioned in 2019.

Electrical Engineer

Electrical Engineer Upgrading the Fire Monitors and Control

System in Sail Room | San Diego Convention Center | San Diego, CA

This project scope of work was detailed design and engineering related to replacement of the Old hydraulic operating Fire monitors with new Electric control Monitors supplied by Elkhart Brass. Also installing New Aspiration Smoke detection (ASD) system, Protectowire Heat detection and installation of New Siemens XLS control panel. Coordination of design with San Diego Fire department and city of San Diego was part of the Engineering task.

Electrical Engineer Land Fill Gas Recovery system Phase V | Stanton Energy Center | Orlando, FL

This project scope of work was detailed design and engineering related to phase V of increasing the capacity of Gas Recovery and addition of New Gas Compressors. The Electrical and instrumentation Design was to prepare all Detailed Electrical Drawing plus Automation and PLC panels, it included single line diagrams, plot plans, Hazardous area Classification, Lighting plan, and Lighting plan. Updating the Etap Model and preparing Short circuit study Report and the Arc Flash label was part of Scope of work.

Electrical Engineer Ground Water Remediation system | P66- Wilmington Refinery | Long Beach, CA

This project scope of work was detailed Electrical and control design and engineering related to drilling of Ten New Ground Water wells around Wilmington Refinery. Scope of work include preparing detailed Electrical and Control drawing package, including Hazardous Area Classification, Emergency shut down panel, preparing IFC and inquiring city permit.



Electrical Engineer
New Filter and Bag House |Gerdau Steel Mill |
Rancho Cucamonga, CA

This project scope of work was to help SMS S.P.A (Italian Engineering/Contractor) in preparing the Electrical design and make it in compliance with local, National Codes, and inquiring city permit. The electrical package include the plot plans, MV and LV Single line diagram and MV & LV switchgears, Hazardous Area Classification, Cable and conduit Routing and Schedule and details.

Electrical Engineer
Additional Desalination System | Southern
California Edison- Pebbly Beach | Catalina
Island, CA

This project was increasing the capacity of existing water treatment units and addition a Desalination unit to the existing units. The scope of work was detailed Electrical and control design and engineering related to installation of new GE RO unit, installing new Transformer and metering unit, New MCC and PLC Panel. Construction support, start up and commissioning was added to the scope of work later.

Electrical Engineer
Oil Transfer Pump | CRC- Freeman and Chaffee
Island | Long Beach, CA

This project was increasing the capacity of existing Oil Transfer Pump from Freeman and Chaffee Island by replacing the existing Oil Transfer Pump with larger Pumps. The scope of work was detailed Electrical and control design and engineering related to installation of new OTP pumps. It required adding new Switchboard, MCC and VFDs. Updating the Etap Model and preparing Short circuit study Report and the Arc Flash labels were part of Scope of work. After completion of the design, Construction support, start up and commissioning were added to the scope of work.

Electrical Engineer
Hose Room | P66- Lube Oil | Los Angeles, CA

This project involved Modifying all the piping in Hose Room, adding new metering skid and adding new pumps to each product Tank. Scope of work was detailed Electrical and control design and engineering related to installation of new pumps, modifying MCCs, preparing the conduit routing and cable and conduit schedules, preparing the I/O list and control panels. Updating the Etap Model and preparing Short circuit study Report and the Arc Flash label was part of Scope of work.

Electrical Engineer
Vapor Recovery Booster Compressor | CRC-
Freeman Island | Long Beach, CA

This project was increasing Efficiency of Vapory Recovery system by adding a Booster compressor to Existing Vapor Recovery System.

The scope of work was detailed Electrical and control design and engineering related to installation of new Booster Compressors. It required adding new feeders to existing MCC and Modifying the PLC panels.

Electrical Engineer
Upgrading the Oil Field Power Distribution
Switchyard | CHEVRON | Bakersfield, CA

This project was improving the quality of the existing Power distribution switchyard by replacing the 115KV Disconnect switches with no protection with ABB Circuit breaker and providing the Protection relays for these feeders by SEL. The scope of work was detailed Electrical and control design and engineering related to installation of these two new ABB low oil Circuit Breakers and SEL feeder protection Relay and protection Relays. It was also included Commissioning and Startup of the Switchyard after installation.

Other related areas of interest

Recognized (Certifications/Trainings)

- Control and instrumentation, PETKIM Petrochemical Co., Izmir/ Turkey
- Supply chain Management course (by APICS) at Gaiser tool Company, Ventura/ CA
- Intermediate/Advance programming of Automation Direct PLC, Irvine/ CA



Mark A. Waer, PhD

Process & GAC / Construction Observation Process Support



and executives.

Education: PhD, Environmental Engineering, University of Illinois; MS, Water Resources Engineering, Villanova Univ.; BS, Pre-Medicine, Pennsylvania State Univ.

Connected: American Water Works Association

Years with GHD: 2 | Home Office Location: Irvine

Awards: Abel Wolman Doctoral Fellowship. Samuel Arnold Greeley Award.

Professional Qualifications: Extensive experience in physical-chemical and biological water treatment process design/optimization, applications research, and water plant operations. Skilled in meeting plant construction, commissioning/start-up, operations training, and support needs of both municipal and industrial clients. Adept at elevating quality while minimizing capital and operating expenses by identifying outside-the-box applications for conventional/new technologies. Knowledgeable regarding water quality standards and regulations. Communicates effectively with all levels of stakeholders, including superintendents, engineers,

Senior Water Process Engineer GRIP AWTF | Water Replenishment District of Southern California | Lakewood, CA

The GRIP AWTF is a 30 MGD Advanced Water Treatment Facility designed to purify tertiary treated wastewater from the San Jose Creek WWTF to an indirect potable reuse standard for groundwater replenishment. The processes include ultrafiltration, reverse osmosis, and advanced oxidation using ultraviolet irradiation. GHD's role as an owner's engineer for the Water Replenishment District includes review of the design and specifications, delivery of regulatory documents, commissioning, startup and operations support. Mark has been particularly involved in the membrane systems (UF and RO) and the chemical handling systems.

Senior Water Process Engineer | Aguas Antofagasta Seawater Desalination Plant | Antofagasta, Chile

In one of the driest regions on earth, Aguas Antofagasta, a Chilean provider of potable water, is in need of a second desalination plant in the north section of Antofagasta called La Chimba. The plant will incorporate ultrafiltration and reverse osmosis along with remineralization using calcite. Mark is serving as the senior reviewer in the Basis of Design and Conceptual Design stages of this project.

Lead Process Engineer | El Morro Desalination Plant | Santiago, Chile

The El Morro Desalination Project was a 740 L/s seawater desalination plant located on the coast of Chile to serve a copper mine located near Vallenar, Chile. The process consisted of dissolved air flotation, ultrafiltration, reverse osmosis, and remineralization. Mark was lead process engineer preparing vendor packages for the process. He led the bid evaluation team through vendor selection, then worked with bid conditioning, P&ID development and revision, and through detailed design. The project was

cancelled at this point due to social and environmental concerns.

Lead Process Engineer | Minera Escondida Desalination Plant | Santiago, Chile

Minera Escondida Desalination Plant was a 3200 L/s seawater desalination plant to serve a copper mine near Antofagasta, Chile. The process consisted of dissolved air flotation, two stages of media filtration, reverse osmosis, and remineralization. Reviewed conceptual design, basis of design, P&IDs, pilot plant planning and construction, and vendor selection. The project was later postponed.

Lead Process Commissioning Engineer and Operations Lead | Bundamba AWTP | Bundamba, Queensland, Australia

Bundamba Advanced Water Treatment Plant is a purified recycled water facility located in Southeast Queensland near Brisbane. The plant receives secondary effluent from several wastewater facilities and applies coagulation, flocculation, sedimentation, microfiltration, reverse osmosis, advanced oxidation with ultraviolet light and peroxide, re-mineralization, and disinfection, as well as the waste streams. The plant was built in 2 phases. During the first phase, Mark was in charge of commissioning the various processes. There was a severe drought at that time and the commissioning team was under a great deal of pressure to bring the plant online. The water was needed to offset water taken from the public water supply dam at Wivenhoe Dam for power plant use. The team was innovative and resourceful and the plant, despite innumerable issues, was brought online on schedule. During the second phase of the project, he was asked to return to provide operational support for the plant as the second phase was brought online.



Lead Process Engineer | Lake Pleasant WTP | Phoenix, AZ

Lake Pleasant WTP is an 80 MGD design-build-operate-maintain (DBOM), green-field water treatment plant employing ACTIFLO® Ballasted Flocculation, ozone, deep-bed granular media filtration, granular activated carbon (GAC) post contactors, and UV disinfection. The plant included its own GAC regeneration furnace. Since this plant was to serve areas that overlapped other City of Phoenix plants service area, the City required a very strict set of water quality goals for the LPWTP. He was involved from the Basis of Design through the Performance Test. He developed the startup plan for the utility. He also developed the compliance strategy for the enhanced regulations imposed by the City of Phoenix; trained the operations staff in the new technologies; and consulted on issues ranging from poor coagulation to GAC furnace operation.

Lead Process Commissioning Engineer | Seymour-Capilano Filtration Plant | Metro Vancouver, North Vancouver, BC

Seymour-Capilano WTP is an 1800 MLD (475 MGD) direct filtration plant which was constructed to provide filtered water to the downtown Vancouver area and beyond. SCFP includes coagulation, flocculation, filtration, UV disinfection, corrosion control, and chlorination. Also, the plant has backwash recovery, sludge dewatering, and effluent treatment. The filters are rated at 15 m/hr (6 gpm/sf). Issues during startup included flow control, filter aid polymer feed problems, problems with the backwash recovery system, lime feed difficulties, and issues with the belt presses for sludge dewatering. One requirement of the contract was to have the plant in service in time for the Vancouver Winter Olympics in 2010. Working with his team, he helped develop solutions to these issues and the goal was met. After startup, Mark stayed on with the plant to aid in operator training, working on-shift with the operators.

Chandler Surface Water Treatment Expansion | Lead Process Engineer | City of Chandler | Chandler, AZ

The goal of this project was to expand the capacity of the Chandler Surface Water Treatment Plant from 45 to 60 MGD, and to make improvements in product water quality including improved filtered water turbidity and distribution system disinfection by-products to meet upcoming regulations. Mark was the lead process engineer for this project from the original kick-off meeting through its commissioning and beyond. He organized and presented workshops for the operational staff to evaluate existing and upcoming regulations, evaluate plant data in comparison to the requirements, introduce the options for technology in the expanded plant, present a decision making model for selection of process technology, and operator training.

Other Areas of Interest

- Past Chair of the AWWA Taste and Odor Committee.
- Past Chair of the AWWA Activated Carbon Standards Committee.
- Member of the AWWA Standards Committee on Water Treatment Plant Operations and Management
- Director of Water, Project Mega Agua, AdapTec SA, Santiago, Chile.
- Former Consultant with Blue Planet Society, Carl Hayden High School, Phoenix, AZ.



John McLaughlin, PE

Security



Qualified: Bachelor of Science, Civil Engineering, Virginia Polytechnic Institute, 1979.Science/Bachelor of Business (BSc/BBus)

Connected: North Carolina AWWA-WEA, National Society of Professional Engineers, Professional Engineers of North Carolina, NC AWWA-WEA Broad of Trustees Chair (2012-13)

Professional Summary: Over 30 years of water and wastewater consulting experience, including planning, design, and construction of all aspects of water and wastewater systems. He is adept at group facilitation and consensus building. John also has an extensive background in emergency management, disaster preparedness and response, and vulnerability assessments for intentional malevolent acts.

Job Manager

CMUD Security Vulnerability Assessment | Charlotte-Mecklenburg Utility Department | Charlotte, North Carolina

John was the job manager on this extensive security Vulnerability Assessment for one of the largest utilities in the Southeast. What made it unique was that it focused on the unmanned facilities in the water distribution system, thus requiring additional focus on proper response protocols and procedures. This process helped inform the client with respect to better emergency response.

Job Manager

DC WASA (now DC Water) Combined Sewer Vulnerability Assessment | District of Columbia Water and Sewer Authority | Washington, DC

John was the job manager on this security Vulnerability Assessment for the combined sewer system for our nation's capital. The project required coordination between 3 different consultant team members, the various departments within DC WASA and all the police and response agencies within the national capital region. Our team was able to blend the best aspects of the RAM-WTM and Vulnerability Self-Assessment Tool (VSAT) methodologies while providing the client with new policies and procedures that took into account the sensitive nature of the locations of many of their most critical facilities.

Technical Adviser and Trainer, Honolulu Board of Water Supply (BWS) Security Vulnerability Assessment | Honolulu BWS | Honolulu, Hawaii

John served as the technical adviser and also provided training during two separate training events for BWS staff and the consultant team in the RAM-WTM methodology. The assessment looked at over 400 remote facilities within a water system that serves the entire island of Oahu and is made up of over 90% groundwater with numerous unmanned facilities.

Recognized (Certifications/Trainings)

- Professional Engineer in NC and SC



H.R. (Omar) Moghaddam, PE, CPP

Permitting/Regulatory Compliance

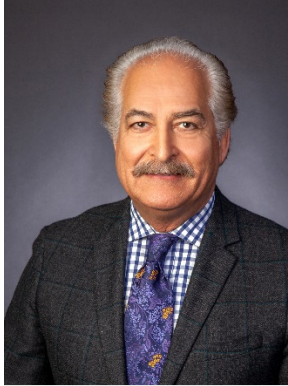

Qualified: Postgraduate studies in Mechanical Engineering and Thermal Sciences, University of Southern California, 1984; M.S. Mechanical Engineering, University of Southern California, 1981; M.S. Petrochemical Engineering, University of Southern California, 1979; B.S. Chemical Engineering, Abadan Institute of Technology, 1976

Connected: Member, California Association of Sanitation Agencies (CASA); Member, California Water Environment Association (CWEA); Member, Southern California Alliance of Publicly Owned Treatment Works (SCAP); Member, Water Environment & Reuse Foundation (WE&RF); Member, Water Environment Federation (WEF), WEF Residual & Biosolids Committee, Bioenergy Technology Subcommittee, and Carbon Resource & Recovery Subcommittee; Member, South Coast Air Quality Management District (SCAQMD) Streamlining Task Force, SCAQMD Hearing Board Advisory Committee; Member, California State Polytechnic University – Pomona Industry Advisory Council; Former member, University of California – Los Angeles Luskin Advisory Board Member

PE Mechanical CA (Issued: February 24, 1983; Expiration Date: December 31, 2021)

Certified Permitting Professional (Issued 1992)

Years with GHD: 2 | Home Office Location: Irvine

Professional Summary: Omar has over 35 years of experience in the design, development, permitting, management, and operation of innovative, sustainable, and complex systems in water, wastewater, stormwater, AWTF water reclamation and purification, and groundwater remediation, watershed management, and water-energy nexus. With a technical advisory and leadership background, Omar pays particular attention to the cost-effective implementation and prudent operation and maintenance (O&M) of environmental projects for the water emphasizing regulatory compliance and energy efficiency. As a Certified Permitting Professional (CPP), he is skilled in coordinating with project owners and operators, regulatory and permitting agencies, environmental constituencies, and stakeholders to secure air quality and water quality permits, NPDES, MS4, and UIC permits. Additionally, Omar was Principal-In-Charge for the development of a comprehensive greenhouse gas (GHG) and criteria pollutants inventory and related reduction strategy platform for the City of Los Angeles's Sustainability pLAN.

Senior Strategic Advisor

Provided strategic coordination and advice for key clients, municipal agencies including LADWP, LASAN Wastewater Program, OCSD regulatory and permitting agencies, environmental constituencies, and community stakeholders on permitting, regulatory affairs, and design and development of technologies related to water/wastewater and Advanced Water Treatment Facilities.

Client Account Manager

Coordinated projects, business development, and marketing strategies for Geo-Environment Technologies and AECOM on clients: LADWP, City of Los Angeles Bureau of Sanitation (LASAN), City of Los Angeles Mayor's Office of City Services and Infrastructure, City of Los Angeles Mayor's Office of Sustainability, Orange County Sanitation District, Los Angeles County Sanitation District, and liaison to the California Association of Sanitation Agencies.

Project Director

Regional Resource Recovery and Carbon Sequestration Facility | Los Angeles, CA

Directed the development of a regional resource recovery and carbon sequestration facility focusing on food waste, total maximum daily loads (TMDLs), bio-slurry, and brine.

Project Director

Power Plant Consulting | Orange County Sanitation District (OCSD) | Orange County, CA

Directed the development of a training program for the operations management team for their on-site central power generation at Plants 1 and 2.

Division Director

Regulatory Affairs and Renewable Resources | City of Los Angeles Bureau of Sanitation | Los Angeles, CA

Lead role in negotiating the discharge permits, NPDES, air quality and biosolids permits, and development of CEQA/EIR for the wastewater treatment and solid waste facilities. Lead role in the development of CHP; advanced water treatment (MF/RO, UV, AOP) and recycled water facilities and brine management; bio-slurry and biogas technologies; air pollution control and de-ammonification.



**Project Director
Compressed Natural Gas (CNG)/Liquid Natural Gas (LNG) Facilities Safety Evaluation | City of Los Angeles Bureau of Sanitation | Los Angeles, CA**

Directed the development of a comprehensive safety analysis, including electrical, mechanical, and structural; Cal/OSHA, and station safety for five CNG/LNG facilities and safety assessment of the CNG/LNG vehicles.

**Project Director
Terminal Island AWTF Brine Management | City of Los Angeles | Los Angeles, CA**

Directed the development of the first-in-the-nation deep injection of biosolids and AWTF's brine management project at the City's Terminal Island Water Reclamation Plant; negotiated three rounds of Class V UIC permit with USEPA; secured over \$10M grants from the Department of Energy, and directed the preparation of the environmental documents CEQA, EIR, Coastal Commission permits.

**Program Manager
Marketing and Design Pursuits | City of Los Angeles Bureau of Sanitation | Los Angeles, CA**

Coordinated marketing strategy, consultant partnering, and engineering advisory across all company work areas including sewer designs, sewer condition assessments, recycled water designs, solid resource pursuits, operational support, stormwater TMDL compliance, energy management, and treatment plant operation enhancements.

**Project Manager
Water System Resiliency Study | Los Angeles Department of Water and Power (LADWP) | Los Angeles, CA**

In coordination with a teaming consultant, developed a resiliency study for the LADWP water system for high water demand during a major earthquake and fire with the focus on hospitals, medical facilities, natural gas and LNG storage facilities, refineries, and hazardous waste management facilities.

**Division Director
Energy and Applied Research | City of Los Angeles Bureau of Sanitation Hyperion | Los Angeles, CA**

Negotiated a 20-year energy exchange agreement between L.A. Public Works and LADWP for import of steam and power in exchange for the export of renewable digester gas for Hyperion. This contract brought upward of \$500 million savings to the City.

**Project Director
Terminal Island Water Reclamation Plant
Biosolids Management | City of Los Angeles | Los Angeles, CA**

Provided the following services for each component of this project:

- **Deep-well Injection of Biosolids and Brine:** Directed the development, UIC permitting, and implementation of the first-in-the-nation, full-scale implementation of the deep-well placement of biosolids and brine at the City of Los Angeles' Terminal Island Water Reclamation Plant. In addition to its biosolids management technique, this project has offered tremendous carbon sequestration effect.
- **Class A Biosolids:** Directed the R&D, and then full implementation of the largest in the U.S. thermophilic, anaerobic digestion, and production of Class 'A' biosolids, in compliance with the EPA's CFR 40, Part 503, for the City of Los Angeles' Hyperion and Terminal Island plants.
- **National Biosolids Partnership Certification:** For 10 consecutive years, lead a team of operators, engineers, and scientists to successfully complete the requirements of the audits in maintaining the NBP's Tier 4 platinum certification of the Environmental Management System Program for the City of Los Angeles, and in advancing the environmentally sound and sustainable biosolids management practices. This program was jointly designed by EPA, WEF, and NACWA.

**Director of Energy and Applied Research
Hyperion Class A Biosolids | City of Los Angeles Bureau of Sanitation | Los Angeles, CA**

In producing Class "A" Exceptional Quality (EQ) biosolids in conformance to the CFR 40, Reg. 503, directed the implementation of the largest-in-the-U.S. thermophilic anaerobic digestion at the Hyperion Treatment Plant and Terminal Island Water Reclamation Plant.



Leila Munla, PhD

Membranes/Pilot Testing

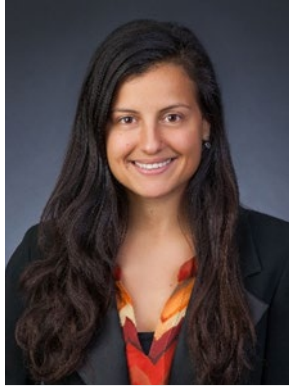

Qualified: PhD, Environmental Engineering, University of Waterloo, Waterloo, Ontario, Canada 2013; BSc, Environmental Science, University of Waterloo, 2006; Civil/Environmental Engineering Technology, Humber College, Toronto, Ontario, Canada 2005.

Connected: American Water Works Association CA-NV Section; Water Reuse, Orange County

Years with GHD: 2 | Home Office Location: Irvine

Professional Summary: Five years of project engineering experience in water and wastewater process design and treatment. Currently, Leila is performing project engineering on Inland Empire's Carbon Canyon Water Recycling Facility and the Rialto Bioenergy Facility, which includes managing permitting, process design, and equipment selection. Leila also has 7 years of experience in membrane filtration systems with a focus on fouling mitigation and quantification, membrane system design and operation.

Project Engineer **Lenain WTP Master Plan and Asset Management | Utilities Department | Anaheim, CA**

Serving as a project engineer for the development of a comprehensive Facility Master Plan including cost and schedule for the replacement and rehabilitation (R & R) of facilities as well as expansion of the LWTP from 15 to 20-22 mgd. The project includes significant pipe treated water pipe modifications to allow the delivery of the additional treated capacity into the distribution system.

The proposed improvements are recommended to maintain Regulatory Compliance and Safety, Water Quality, Plant Reliability, and Flexibility for Plant Expansion. Currently providing engineering services during construction and specialty inspection/resident engineering and startup/commissioning services. Construction is scheduled to be completed by end of 2019. Existing influent and effluent pipelines at LWTP will be upsized from 24" to 36" and will be co-located in the LWTP Secondary Access Road. This new location of the influent and effluent pipelines will increase accessibility for maintenance. Additionally, the Secondary Access Road will be widened to facilitate the flow of vehicles at LWTP. It is anticipated that the cost of the Secondary Access Road improvements will be partially offset by the plan to install new Influent and Effluent pipelines in the road.

Project Engineer **Engineering Design Guidelines | Inland Empire Utilities Agency | Rialto, CA**

Project engineer for the development and update of the Engineering Design Guidelines to communicate design preferences of the Inland Empire Utilities Agency (IEUA) to its consulting engineers/designers to improve consistency and efficiency of project deliveries. Significant workshops and staff interactions were utilized to build consensus regarding Guidelines format.

The Guidelines were developed in tabulated forms to improve their read and ease of future modifications and/or additions. The level of completeness and usefulness of these Guidelines will improve with their use and updates. The level of details included in the Guidelines was targeted to the 30-percent design level. The tabulated format will be helpful to incorporate into Preliminary Design/Basis of Design documents. The level of details/requirements were developed with emphasis on technical areas that are common sources of inconsistencies during designs. Currently updating the Guidelines and adding new technical sections and coordinating its content with the Front End Contract Documents that have been recently updated by GHD. The updated Guidelines are scheduled for publication in late 2018.

Project Engineer **3A Water Recycling Plant Improvement Projects | Moulton Niguel Water District | Mission Viejo, CA**

Serving as Project Engineer for the Moulton Niguel Water District 3A Water Recycling Plant Improvement/Upgrade Projects. GHD is providing Owner Engineering services for plant rehabilitations and replacements required to reliably meeting its rated capacity of 6 mgd. Initial efforts are focusing on facility condition assessments; project definitions; budgetary cost estimations; and prioritizing of plant improvements. Major improvements to the plant include equipment rehabilitation, process optimization, development of standard operating procedures and enhancements, technology evaluations, and site subsidence mitigation. GHD is working on developing RFPs for improvements and upgrades to the solids and liquid treatment train processes including initial technology assessments and evaluations of alternatives to better define design efforts for the required improvements/upgrades. GHD efforts include guiding design efforts to be performed by others and reviewing all submittals for these improvements/upgrades. The total



construction cost for the plant rehabilitations and replacements is estimated to be in the order of \$15M.

Project Engineer
Carbon Canyon Water Recycling Facility –
Asset Management and Improvements
Package III | Inland Empire Utilities Agency |
Chino, CA

Serving as Project Engineer for the CCWRF Asset Management and Improvements Project. IEUA launched the CCWRF Asset Management and Improvement projects in order to improve a number of processes at CCWRF based on input from Operations, Maintenance, Engineering, O&M Documents, and Asset Management Plans. GHD is providing design services for Package III of Asset Management and Improvements at CCWRF.

GHD is completing the detailed design for the following improvements: Replace Leaky Influent and Effluent Tertiary Filter Weirs; New Flocculation Basin Overflow Weir; Demolish Abandoned Chlorine Disinfection System; Replace Filter LCP with a new PLC and integrate to SCADA; Refurbish Corroded Monorails; Refurbish and/or Replace Filter Backwash Troughs; Refurbish or Replace Cast Iron Tertiary Filter Gates; Extend Concrete Lining at the Emergency Storage Lagoon; New Flow Meters at the CCB; Increase Reliability of Plant Utility Water System; Replace Drain Valves and Plug Valves at CCB and Tertiary Filters.

Permitting Manager and Process Design
Rialto Bioenergy Facility (RBF) | Confidential |
Rialto, CA

Expediting permitting for the RBF project with the City of Rialto including demolition, rough/precise grading and building permit issuance. Also serving as a project engineer for the development of the process design and P&IDs.

GHD is providing preliminary and detailed engineering service including civil, water quality and hydrological design for a 2,000 ton per day waste processing facility on 6.5 acres. Half of the incoming material is biosolids and the remaining from large post-consumer food waste slurries. The site will be developed for material receiving, storage, anaerobic digestion involving 3.5 million gallon digesters, two belt dryers for the digestate and biosolids, biogas upgrading to fire onsite appliances, biogas upgrading to RNG quality, CHP units with net 5 MWe, 3MWe transfer switch for net electrical export, use of CHP jacket heat, CHP exhaust heat, battery for peak-electrical use shaving, and a pyrolysis unit to burn dried pellets into a biochar complete with syngas cleanup and firing of onsite appliances. In total, the site is estimated to produce 14 MW of electrical and thermal renewable energy.

Project Engineer
CalFire Greywater Treatment System and
Rainwater Capture | CalFire | San Diego, CA

Designed the greywater treatment system and rainwater harvesting for a CalFire station requiring additional water supply for fire truck washing and irrigation. Optimized tank storage and daily disinfection process for stored water. Created design templates for larger scale CalFire stations. This project served as a benchmark in both design and regulatory precedent to be applied at other CalFire stations.

Project Engineer
Catalina Island Conservancy Trailhead Visitor
Center | Catalina Island Conservancy | Catalina
Island, CA

Designed the water treatment and reuse processes for desalination and rainwater harvesting and storage for Catalina Island's first LEED certified building. Quantified storage including tank size and location required for rainwater and desalinated water as well as designing the delivery process system.

Process Engineer
San Diego Gas and Electric Substation Fire
Storage | SDG&E | Otay, CA

Upgraded a water storage tank and associated piping and valves for fire protection at an SDGE substation. Replaced old valves and refurbished the inside of the tank due to aging and corrosion. Designed a mixing and automated chlorine dosing disinfection system to maintain water quality.

Other related areas of interest

Recognized (Certifications/Trainings)

- Current Chair of the Women's Leadership Committee, AWWA California-Nevada Section.
- Past Vice-Chair of the Leadership Development Committee, AWWA California-Nevada Section.

Awards

- AWWA CA-NV Section 2015 Chair's Award for dedication and leadership in organizing and facilitating women's networking and professional development workshops at the Section conferences.
- Submitted to the University of Waterloo for a Graduate Research Scholarship for research on ceramic membranes for surface water treatment. The submission was accepted and approved for funding of the PhD research project.



Andrew Peek

Durability and Corrosion



Qualified: MSc (Applied Chemistry) Curtin University of Technology, BAppSc (Chemistry) Western Australian Institute of Technology, Chartered Chemist.

Connected: Member of the Concrete Institute of Australia's National Concrete Durability Committee Task Group TG6, co-author of Recommended Practice Z7/07 "Performance Tests to Assess Concrete Durability", also a reviewer and contributor to Z7/02 "Durability Exposure Classification" and Z7/05 "Modelling of Reinforcement Corrosion in Concrete Structures".

Years with GHD: 18 | Home Office Location: Perth, Western Australia

Professional Summary: Over 30 years' experience in durability, deterioration, protection and testing of construction materials related to the performance of conventionally, pre- and post-tensioned reinforced concrete structures in marine and hypersaline exposures and other aggressive environments such as mining/mineral processing, desalination plants, water and wastewater handling and treatment, transport infrastructure and heavy industry. His experience includes durability planning and specification for new installations, condition assessment and

remedial works, failure investigation, and the design and implementation of materials performance test programs. Andrew has provided these services to a diverse range of clients in Australia, New Zealand, Singapore, Hong Kong, Malaysia, Vietnam, Indonesia, USA and UAE.

Durability Design Lead Neerabup GWTP Upgrade Westforce-Sacyr JV | Perth, WA, Australia

Preparation of Durability Plan, durability design support and construction support to upgrade 100 ML/d ground water treatment plant (GWTP) to 150 ML/d.

Lead Durability Consultant Mundaring WTP and Pump Station C Brookfield Multiplex | Mundaring, WA, Australia

Durability consultant to head contractor for the first Water Corporation public private partnership (PPP) project in WA (\$360M). Construction of 160 ML/d expandable to 240 ML/d potable water treatment plant and pump station providing all potable water to the Goldfields and Agricultural Region Water Supply Scheme (GAWS). GAWS is the largest water supply network by area in the southern hemisphere. Detail design and construction phase implementation of durability plan for key structures comprising DAFF tank, BAC filters and rinse/supernatant tank, flocculation chamber, back wash water tank, balancing and chlorination tanks, clear water tanks, wash water balance tank, sludge tank and pump station.

Owner's Engineer Durability Consultant Onslow WTP Upgrade Water Corporation WA | Onslow, WA, Australia

Owner's Engineer review of proposed materials to meet durability requirements for construction of a new ground water treatment plant for the Onslow town supply in conjunction with construction of the Wheatstone LNG plant.

Owner's Engineer Principal Durability Consultant Kwinana SWRO Desalination Plant

Water Corporation WA | Kwinana, WA, Australia

Member of owner's independent review panel on concrete durability and protection for D&C tender and detail design submissions for 150 ML/d SWRO desalination plant. Technical support regarding protective coatings and linings, sealants, and deterioration modelling durability services covering design brief, review of tender design, review of detailed design and technical support on request during construction. Materials technology assessment included compliance with the Durability Plan, coatings application, sealant application, chloride ingress deterioration modelling and support on request for durability consultant input. Structures included seawater intake, permeate and drinking water tanks, limewater tank, brine effluent structures and backwash tanks, and buildings containing the desalination process.

Owner's Engineer Durability Consultant Carlsbad SWRO Desalination Plant Poseidon Water | Carlsbad, California, USA

Provided durability advice for Carlsbad 50 million US gallon per day (mgd) (~190 ML/d) SWRO desalination plant for concrete structures, including technical review of durability modelling at design stage, advice on feasibility of retaining existing former power station outfall structures, and technical review of remediation proposals for repair of construction defects.

Owner's Engineer Durability Consultant Huntingdon Beach WWRO Desalination Plant Poseidon Water | Huntingdon Beach, California, USA

The new Huntingdon Beach Wastewater Desalination Plant treats wastewater for injection into a freshwater aquifer, which is used in the Los Angeles municipal water supply, to mitigate seawater intrusion. Provided durability



advice for concrete structures including repair of construction defects, and advice on feasibility of retaining existing former power station outfall structures.

Specialist Corrosion Consultant
Newman WTP Reject Brine Disposal
BHP Billiton Iron Ore | Newman, WA, Australia

Corrosion resistance study of mineral processing plant construction materials to assess feasibility of reject brine disposal from two inland RO desalination plants (Newman town supply and Yarnima Power Station) by blending with mine dewatering to use as process water in minesites and ore processing plant. Included modelling of effects of various current and predicted future flow and brine composition scenarios on the blended water chemistry, demonstrating technical feasibility of the proposal.

Principal Durability Consultant
Alkimos WWTP
Brookfield Multiplex | Alkimos, WA, Australia

Tender and detail design stage durability planning for Alkimos WWTP, initial 20 ML/d expandable to 160 ML/d full future capacity. Largest WWTP structures in WA at that time. Concrete and protective coatings specifications and materials evaluation. Construction technical support.

Durability Consultant
Mackay Water Recycling Project
Cleaner Seas Alliance | Mackay, Queensland, Australia

Interpretation of laboratory test data for assessment of condition and provision of durability advice for two wastewater treatment plants and two wastewater pump stations proposed for upgrade in Mackay Water Recycling Project.

Specialist Durability Consultant
Asbestos-Cement Water Mains Replacement
Charters Towers Regional Council | Charters Towers, Queensland, Australia

Condition assessment, diagnosis of deterioration mechanisms, and remaining life modelling of municipal asbestos-cement potable water mains. Both supply mains from the Burdekin River source to the treatment plant, and town distribution mains, were assessed for current pressure rating and likely time to replacement. The condition assessment was made through petrographic and SEM/EDX examination of hot-tapped core samples retrieved from the pipes while the system was live. Current pressure capacity was estimated from the dimensions of the remaining sound cross-section, with likely remaining service life estimated using deterioration rate constants calculated from the age and depth of deterioration.

Durability Design Presenter
Durability Design in Desalination Plants
USA and Australia

Preparation and delivery of presentations on durability engineering and plant reliability to US water authorities (El Paso TX and Irvine CA) and Department of Trade hosted delegation of US water asset owners (Perth).

Other related areas of interest

- **Published.** Over 40 conference and journal papers, presentations to professional societies, and presentations to government-sponsored industry events.
- **Recognised.** Twice awarded the A.C. Kennett Award for Best Paper on Corrosion of Non-metallic Materials, and awarded the David Whitby Review Paper Award, for papers published at the Australasian Corrosion Association's international peer-reviewed conferences. Concrete Institute of Australia 2017 National Excellence in Concrete Award – Technology & Innovation for the remaining life assessment of the Wandoo B offshore concrete gravity structure.
- **Memberships.**
 - Royal Australian Chemical Institute.
 - Australasian Corrosion Association.
 - Concrete Institute of Australia.
 - National Association of Corrosion Engineers.
 - Society for Protective Coatings.
 - American Concrete Institute.
 - Surface Coatings Association of Australia.



Casey Raines, PE

Pipeline/Infrastructure



Qualified: California State Polytechnic University, Pomona, CA. Bachelor of Science in Civil Engineering, 2007

Registrations: CA#C76713 Issued July 2010, Expires December 2020

Connected: California Water Environment Association, North American Society for Trenchless Technology, Orange County Water Association

Years with GHD: 6 | Home Office Location: Irvine

Professional Summary: Ms. Raines is a registered professional civil engineer with extensive experience in the design, planning and rehabilitation of domestic water, recycled water and wastewater pipelines. Her emphasis has been in drafting, hydraulic system modeling, master planning, and design of plans for pipelines pump stations, wells and reservoirs. Her experience in hydraulic system modeling has included regional and citywide water and sewer distribution master plans using both steady state and extended period

simulations; fire flow assessments and sewer capacity studies for new developments; pump station and discharge piping improvement studies; and reservoir capacity analyses. Ms. Raines is NASSCO certified in the evaluation of CCTV inspections and assessment of pipe conditions. This certification has resulted in the expertise with various rehabilitation methods including CIPP and point repairs.

Project Engineer **Carlsbad Ocean Water Desalination** **Conveyance Pipeline | Poseidon Resources, CA**

Project engineer for the design review of the Carlsbad Ocean Water Desalination Conveyance Pipeline. GHD is currently the owner's engineer for the Carlsbad Desalination Conveyance Pipeline that will deliver an average flow of 50 MGD of desalinated ocean water from the future Carlsbad Ocean Desalination Plant to the SDCWA's Twin Oaks Valley Water Treatment Plant. The transmission pipeline system is comprised of approximately 53,000 feet of 54" diameter steel pipeline with a shell thickness up to 0.900-inches to withstand a working pressure of 550 psi and surge pressures exceeding 1000 psi.

Project Engineer **P-1046B Recycled Water Conveyance** **Facilities | Camp Pendleton, CA**

Project Engineer for the P-1046B Recycled Water Conveyance Facilities project that will expand the use of recycled water at the Marine Corp Base Camp Pendleton and improve the water aquifer by providing a seawater intrusion barrier. The project includes two pumping stations, over 50,000 linear feet of reclaimed water pipelines, four horizontal directional drill crossings, service connections, 350,000 gallon reservoir, sixteen injection wells for seawater intrusion barrier, and two 75,000 gallon balancing reservoirs. The design includes preparation of permit applications for injections wells, recycled water services, and approval of pipe separations for potable/ recycled/ wastewater lines.

Project Engineer | Newport Coast Sewer Lift **Station Rehabilitation | Irvine Ranch Water** **District, CA**

Project Engineer for the rehabilitation of the Newport Coast Sewer Lift Station consisting of a new CMU block electrical building, a new stairway to the dry well, CIPP lining of the existing 12-inch DIP sewer force main, rehabilitation of the wet well concrete and coating, and the redesign of the pump discharge piping to install flow and pressure monitoring devices. A comprehensive bypass pumping plan was also developed to allow the contractor to rehabilitate the wet well and reconfigure the discharge piping within the dry well. GHD's tasks for the rehabilitation included a condition assessment of the wet well and sewer force main, along with the preparation of bidding documents including plans, specifications, and a cost opinion.

Project Manager | Seawatch Recycled Water **Main Rehabilitation | Irvine Ranch Water** **District, Newport Beach, CA**

Project consisted of the rehabilitation of a 10-inch recycled water main in a fire access road between two communities in Newport Beach. The recycled water main had required several emergency repairs due to failures from improper construction methods. An alternatives analysis was completed examining various rehabilitation methods including CIPP, sliplining, pipe bursting and full replacement. The project recommended CIPP lining approximately 4,500 LF and a full replacement of the existing ductile iron main in place for approximately 140 LF at the connection to the PRV vault. Access pits were designed to facilitate the installation of the CIPP lining along with the reconnection details using internal mechanical seals.



Project Engineer
Wineville Pipeline Extension | Inland Empire Utilities Agency, Ontario and Fontana, CA

Assisted with the design and construction of 6 miles of pipelines including 5 miles of 36-inch and 1 mile of 24-inch welded steel pipelines to extend the Agencies recycled water system from the City of Ontario to the City of Fontana. This project included hydraulic modeling of the recycled water system to determine appropriate pipe diameters by running average daily demand, maximum daily demand, and ultimate deposition into the Agency's groundwater recharge basins. It also included the preliminary and final design of the pipeline, turnouts to IEUA customers including private properties and the Fontana Water Company, and turnouts discharging recycled water to groundwater recharge basins at the IEUA RP-3 site and the SBCFCD Declaz Channel. This included the specification of a 28-inch and 16-inch plunger valves enabling the pressurized recycled water system to discharge to open atmosphere. Other design elements included mitigating several storm drains, flood control channel crossings, railroad crossings through pipe bridges and bore and jack construction methods.

Project Engineer
Mountain View Park New Well and Raw Water Transmission Pipeline | Chino, CA

Project Engineer for the preparation of a Preliminary Design Report and construction plans for a new water well at the Mountain View Park in the City of Chino and a raw water transmission pipeline along Mountain Avenue, Chino Avenue and Bon View Avenue. A hydraulic analysis was completed in H2ONet Analyzer to appropriately size the transmission pipeline based on the contribution of groundwater from three wells. The proposed improvements include the development of the well site with a building that will enclose the well, pump discharge line and electrical equipment and approximately 12,500 linear feet of 12-inch to 24-inch raw water pipeline.

Project Engineer
Philadelphia Force Main Improvements and Regional Force Main Improvements | Inland Empire Utilities Agency, Ontario, CA

Project consists of improvements to the Philadelphia, Montclair, and San Bernardino Lift Station force mains operated and maintained by IEUA. Improvements include construction of two new parallel 18-inch non-reclaimable waste force main pipelines for the Philadelphia Lift Station at 14,800 LF each, construction of clean out valves along the force mains at 500-ft intervals, condition assessment of the Montclair and San Bernardino Avenue Lift Station force mains, temporary sewer bypass plans, and site grading modifications at the Montclair Lift station. Specific project tasks included a comprehensive preliminary design report to analyze various alignment alternatives; design of trenchless alignments including a geotechnical

baseline report; permitting with various cities, Caltrans, and Union Pacific Railroad; and development of construction plans, technical specifications, and cost opinion.

Project Engineer
Relocation of Feeder No. 2 | West Orange County Water Board

Project Engineer for the relocation of the West Orange County Water Board's Feeder No. 2 water transmission main due to impacts from the widening of the Interstate 405 freeway. The relocated 30-inch water transmission main is located in Mahogany Avenue and crosses the Interstate 405 freeway to Willow Lane. The portion beneath the Interstate 405 freeway is constructed via microtunneling within a 42-inch steel casing. Other specific tasks included permitting and coordination with Caltrans, City of Westminster, and Cal-OSHA; development of traffic control plans; geotechnical investigation; potholing; and development of construction plans, technical specifications and cost opinion.

Project Engineer | Rose Canyon Trunk Sewer Joint Repair Project | City of San Diego, CA

Project Engineer for the rehabilitation of a portion of the Rose Canyon Trunk Sewer (RCTS) consisting of 4.5 miles of 54- and 60-inch T-Lock PVC lined RCP piping. Numerous trenchless rehabilitation options were evaluated to repair the failed plastic liner weld strips and the potential environmental, encroachment and traffic impacts of the rehabilitation were considered. Internal mechanical pipe seals and new plastic liner strips were selected to repair the pipe joints installed via manned entry of the trunk sewer. Although labor intensive, these methods were the least invasive to the Rose Canyon habitat and also the most cost effective. To complete the necessary repairs, a 32 MGD bypass system was designed consisting of two temporary pump stations, 2,100 LF of 32-inch HDPE bypass piping, and the installation of fabricated aluminum stop logs and a temporary bulkhead upstream of the work.

Project Engineer | Pacific Avenue Trunk Sewer Rehabilitation Project | Long Beach Water Department, CA

Project engineer for a sewer rehabilitation program in Pacific Avenue between 36th Street and Wardlow Road consisting of 7 sewer segments. Three segments were identified for point repairs and the remaining four segments were identified as lining projects. The rehabilitation also included the reconstruction of three manholes. Specific tasks included identifying the pipes in need of rehabilitation; proposing appropriate rehabilitation methods for various pipe conditions; coordinating with other utilities; and preparing plans, specifications, and cost estimates for the implementation of the rehabilitation program.



Chris Richards, PE

Telemetry



Qualified: Bachelor of Science, Electrical Engineering, 2002, California Polytechnic State University, San Luis Obispo, CA; Electrical Engineer: CA #E17660; Construction Documents Technologist (CSI)

Connected: Member BICSI Telecommunications Association

PE Electrical CA (Issued June 24, 2005; Expiration Date: September 30, 2021)

Years with GHD: 17 | Home Office Location: Santa Rosa

Professional Summary: Mr. Richards has 17 years of experience in the design and implementation of electrical systems. His design experience includes medium and low-voltage design for industrial, educational, laboratory, commercial, and residential power, power generation, photovoltaic generation, cleanroom applications, data and server rooms, lighting, telecommunications, security, audio/visual, and fire alarm systems, power and lighting system analysis and modeling, arc flash and coordination studies, LEED® credit driven design and documentation, and CA Title 24 lighting efficiency & lighting control measures.

Staff Electrical Engineer Dechlorination Facility | Novato Sanitation District | Novato, CA

Staff electrical engineer for the sodium hypochlorite injection facility used to remove chlorine from the outfall. This project involved power supply distribution, chlorine and hypochlorite measurement and analysis and radio telemetry back to the Marin wastewater treatment plant.

Staff Electrical Engineer Power Quality Analysis | City of Rohnert Park | Rohnert Park, CA

Staff electrical engineer, performing a Power Quality Analysis (Harmonic Distortion Analysis) for three (3) 200 HP variable frequency drives at the waste water pump station. A time line was developed for phased replacement of the 6-pulse VFDs to meet City's budgetary constraints.

Staff Electrical Engineer Napa Sanitation Ventilation Upgrades | Napa, CA

Staff electrical engineer designed a variety of systems to improve the ventilation of work areas which included alarm systems to detect hazardous gasses, SCADA interface with existing systems, power distribution to the fans and hazardous gas monitoring systems.

Staff Electrical Engineer Napa Sanitation Lighting Upgrades | Napa, CA

Staff electrical engineer for this project. The purpose of this project was to improve the existing lighting of the wastewater treatment plant.

Staff Electrical Engineer Stevenson Pump Station | Union Sanitary District | Novato, CA

Staff Engineer for this project which consisted of predesign and design of this 9.0 mgd wastewater pump station and 20-inch HDPE force main that will take the

place of two existing pump stations. Provided the design of a wastewater pump station including service generator size, load calculations, and PG&E service applications.

Staff Electrical Engineer Bel Marin Keys Pump Station No. 5 | Novato Sanitary District | Novato, CA.

Staff electrical engineer providing design for the design of a replacement sewage pump station conveying flows from the Bel Marin Keys neighborhood to the Ignacio Treatment Plant including service sizing generator size, and load calculations. Located on a small site, the new pump station will be constructed while the existing pump station continues to operate. The new 1800 gpm facility will be a submersible pump station.

Staff Electrical Engineer Vallejo Grid Pump | Vallejo, CA

Staff electrical engineer for this project. Replaced three natural gas driven water pumps for the City with three pumps driven by variable frequency drives (VFD).

Electrical Engineer Novato Sanitation District Wastewater Facilities Upgrade | Novato, CA

Electrical engineer for the project to combine and upgrade the Ignacio and Novato Treatment Plants into a single 55MGD wastewater treatment facility at the site of the existing Novato Treatment Plant. The project included upgrading to a 12,470-volt PG&E service with medium voltage transmission over the site to a district owned transformer and metal-clad switchgear, and low-voltage distribution to influent, treatment and effluent processes. The design included power distribution, lighting and implementation of a distributed SCADA system. The SCADA system generally consisted of local controllers with touch screen interfaces, local and remote I/O for monitoring and controlling process conditions, and recording and database operations at a central control station manned by District personnel.



Chris Richards, PE

**Electrical Engineer
West College Utilities Facility Short Circuit,
Arc Flash, and Coordination Study | Santa
Rosa, CA**

Electrical Engineer tasked to perform a Short Circuit, Coordination, and Arc Flash Study for the overall project site. The tasks included integrating the single line diagrams and as-built conditions for the various phases of construction, on-site verification of existing systems and settings, and creation of a SKM PowerTools model for the entire facility. Using the model, GHD determined recommended device settings to achieve selective system coordination, short circuit current levels, and produced Arc Flash labeling for the various electrical equipment on site to advise site personnel of the local incident energy levels.

**Electrical Engineer
City of Santa Rosa Utilities Field Office | Santa
Rosa, CA**

GHD prepared plans and specifications for a Solar PV system having a combined total capacity of 150 kW with a potential future build-out to 500 kW. The PV system design utilized high efficiency, mono-crystalline silicon, all-back contact solar cells in order to maximize the power production in the limited roof top area. Both 10-degree tilted and standing seam integrated-rail mounting systems were used. Alternate design options were considered including the use of flexible photovoltaic laminates on the standing seam roof as well as a proposal for an interlocking, insulated & self-ballasted flat panel system. Compatibility of the PV system with the 600 kW backup emergency generator system was analyzed which resulted in a modified PG&E interconnection scheme.

**Electrical Engineer
Maintenance Facility Expansion Lighting |
Mendocino Transit Authority | Ukiah, CA**

Mr. Richards was the Electrical Engineer for the development of a master plan for upgrading and "greening" the facilities. The concept design documented specific office, maintenance, parking, support and circulation space required for current and future operations. The detailed analysis provided recommendations on grading, site utilities, electrical power upgrades including power generation capacity, improved fencing, site lighting and security, covered parking, improvements to the wash bay. The recommended fleet maintenance building includes photovoltaic panels. The recommended administration and operations building includes showers, lockers, and a kitchen and break room. The project was completed on time and budget and the master plan is supporting MTA's grant-writing activities.

**Electrical Engineer
Service Center Relocation at 2025 Aviation
Blvd | Sonoma County Water Agency | Santa
Rosa, CA**

Electrical Engineer for the Water Agency's project at their ALW treatment plant to renovate portions of the existing 6,600 sf building and to add a new 5,000 sf Service Center building complete with space for offices, storage, Labs, and 2 large service bays for vehicle maintenance. The electrical engineering design scope included medium voltage distribution, and low voltage normal and standby power distribution for each building. Signal systems included data, voice, security, fire alarm, and CCTV, with associated racks and infrastructure. Interior and exterior lighting systems included "intelligent" daylighting, dimming, local area controls, and egress lighting. All lighting was designed to meet or exceed CA Title 24 requirements.

**Electrical Engineer
204 Concourse Blvd Tenant Improvement |
Sonoma County Water Agency | Santa Rosa,
CA**

Electrical Engineer for the Water Agency's tenant improvement at 204 Concourse Blvd. The building consisted of approximately 25,000 sf of mixed use space, including modifications to create private office space, open office workstations, conference rooms, shops, server and SCADA rooms, a small shop and parts inventory space, and miscellaneous service and support spaces.

The electrical engineering design scope included normal and standby power distribution for each area, including machine tool power and uninterruptible power for the control and data centers. Signal systems included data, voice, security, fire alarm, and SCADA, with associated racks and infrastructure. Interior and exterior lighting systems included "intelligent" daylighting, dimming, local area controls, and egress lighting. All lighting was designed to meet or exceed CA Title 24 requirements.

**Staff Electrical Engineer
Mendo Lake Credit Union | Fort Bragg, CA**

Electrical Engineer for the design of a 3,000 sf. LEED certified credit union building. Designed power systems including building distribution, supply to mechanical equipment, and a standby generator. Designed interior and exterior lighting systems including advanced user programmable lighting controls to meet LEED and CA Title 24 requirements. Completed LEED forms required for electrical portion of the certification.



James Taylor

Safety/HIS



Connected: American Water Works Association; Arizona Water Association.

Professional Summary: James joined GHD in 2012, bringing more than 25 years of experience in the operation, maintenance, and management of water and wastewater utilities. He has worked as an Operations Manager and Utility Manager for multiple water and wastewater providers throughout the southwest. James has worked as a Project Manager and Operations Manager for 10 years, specializing in water and wastewater operations maintenance and asset management programs.

Senior Project Manager **Environmental Health and Safety / Security** **Assessment | EPCOR Water USA | Phoenix AZ**

Coordinated and led a team of professionals with combined experience of over 100 years. To deliver the client with a detailed 3rd party examination of environmental compliance policies and procedures, employee health and safety programs, facility security and operation and maintenance programs in order to provide recommendations designed to identify risk and continue the owners commitment to constant improvement.

Operations Manager **Global Water Resources | Phoenix AZ**

Provided leadership, oversight and management of water treatment and distribution facilities for the Global Water Resources west valley district. This included the direct supervision of all west valley region operations and maintenance (O&M), customer service and compliance staff. James was directly responsible for the financial performance, operational compliance and vastly improved customer satisfaction.

Operations Supervisor **Arizona Water Company | Phoenix AZ**

Provided leadership, oversight and management of water treatment and distribution facilities for the Sun City, Sun City West, Agua Fria and Surprise water districts. This included the direct supervision of all operations and maintenance, staff. James was directly responsible for the financial performance, operational compliance and vastly improved customer satisfaction. During this period of unprecedented growth, the team set new benchmarks in efficiencies and safety.

Operations Project Manager **Commissioning, Agua Fria Water Treatment** **and Pumping Facilities | Arizona Water** **Company | Phoenix, AZ**

Supervised the operation, start-up, and commissioning of 9 water booster stations in series with capacities from 2 to 10 mgd. Services included developing reliable operations, documenting operating procedures, staff training, and optimizing chemical and energy use and staff utilization.

Operations Supervisor **Private Water Company Evaluation Citizens** **Utilities**

Conducted an asset inventory, assessment, and valuation of a private water company to assist Citizens Utilities in determining the feasibility of acquisition. Compiled asset information on production facilities, including condition assessment, and projected remaining useful life. Determined operating conditions cost and capital improvement requirements.

Operations Project Manager **Lake Pleasant Water Treatment Plant |** **Arizona Water Company | Phoenix, AZ**

As part of the design team the Lake Pleasant Water Treatment Plant was designed in 2003 and to meet the urgent needs to address future water supplies for one of the nation's fastest growing metropolitan areas. Opened in 2007 the facility was constructed with an initial capacity of 80MGD and ability to expand to 320MGD keeping pace with future development in northern Phoenix. Incorporating the latest in modern water treatment technology the facility comprises of an intake structure, pumping station and 90-inch diameter pipeline to deliver raw surface water 2.3 miles from the Waddell Canal to the 225-acre treatment plant site. The facility utilizes a multi-barrier process that includes ballasted flocculation, ozonation, filtration and secondary filtration through granulated activated carbon contactors,



ultraviolet disinfection, and solids processing. A 40-MG finished water storage reservoir and pump station serving multiple pressure zones. Serving a population of 400,000 the facility represented the largest DBO in North America.

**Operations Project Manager
White Tanks Regional Water Treatment
Facility | Arizona Water Company | Surprise,
AZ**

As part of the design team, and utilizing Central Arizona Project surface water the facility allowed West Valley water providers the ability to reduce reliance on groundwater sources and utilize renewable CAP water supplies. With a capacity of 13.5 MGD and serving a population of 30,000 residents this facility saves 3 billion gallons of groundwater per year, with the future capacity to provide 80MGD and serve 250,000 residents.

Key components of the facility include raw water intake screening, storage and pumping stations. Treatment processes including flocculation, dissolved air flotation clarification and granulated activated carbon as well as sand filtration. The finished water process includes UV light disinfection, chlorination, storage and distribution service pumps. Utilizing state of the art security systems and supervisory control and data acquisition SCADA systems the facility sets the standard for the industry.

**Operations Manager
Global Water Resources | A.M.M.S. System |
Phoenix AZ**

Supervised the development and implementation of the Asset Management Maintenance System resulting in immediate operational expense reductions and improved asset effectiveness and improved life cycles. Supervising a team of specialized experts and staff at all levels, initially conducted an extensive audit of assets and condition. Developed program requirements and recommended improvements then prepared a detailed plan for implementing the recommended improvements including priorities and resource requirements. Developed asset data requirements, data management systems, and condition inspection requirements for wells, pump stations and other appurtenances for water distribution, and production. Conducted asset inventory and condition assessment of wells and distribution facility electrical equipment. Assisted in constructing on-line data system for compiling asset and inspection data, and production data from the existing SCADA components.

**Operations Manager
Treatment Optimization | Global Water
Resources | Phoenix, AZ**

Developed and implemented programs intended to establish baseline information including standard operating procedures, conducted on-site inspections

that included testing of treatment processes, and evaluating treatment system's efficiency's. Completed reports calculated to highlight potential savings and how chemical optimization improvements can be facilitated. Researched and provided recommendations for alternative treatment processed designed to reduce operational expenses.

**Operations Supervisor
Emergency Response and Troubleshooting |
Arizona Water Company | Phoenix, AZ**

With over 20 years' experience in all aspects of water and wastewater treatment, distribution and collections James possesses the skills to quickly analyze emergency situations, provide recommendations and implement corrective actions intended to quickly and safely resolve critical system failures.

**Senior Project Manager
Water and Wastewater System Condition
Assessment, Operations and Maintenance
Program Development | City of Carlsbad |
Carlsbad, CA**

Performed facility condition assessments (FCA) for the potable water distribution and pumping facilities as well as the recycled water pumping stations and pressure control stations. Developed standardized condition assessment protocol, and developed strategies to optimize the life or effectiveness of the assets. GHD conducted the FCA along with Carlsbad staff in order to provide training and gain institutional feedback during the condition assessment. The results of the FCA were incorporated into the asset register. Analyzed collected data to calculate the estimated replacement costs of assets. Completed a workshop with stakeholders to review and develop strategies for rehabilitation and develop budget strategies. Reviewed and recommend management strategy groups for incorporation in the asset register and presented the initial management strategies to Carlsbad staff in a workshop and worked together to refine the management strategies. The workshop will included a discussion of rehabilitation efforts, along with replacement costs. This project is ongoing.

Other related areas of interest

Recognized (Certifications/Trainings)

- ADEQ operator certification # OP11500
- Wastewater Treatment Operator Grade 2, AZ
- Wastewater Collection Operator Grade 2, AZ
- Water Treatment Operator Grade 3, AZ
- Water Distribution Operator Grade 4, AZ
- Class A AZ Contractor ROC # 264121
- HAZWOPER 40 hour, Supervisor Certified



Larry B. Tortuya, PE

Stormwater



AutoDesk Civil 3D software.

Qualified: B.S., 2004, Civil Engineering, California State Polytechnic University, Pomona A.S., 2000, Engineering, Long Beach City College CA# C67618

Connected: American Society of Civil Engineers, Society of American Military Engineers, American Public Works Association, Filipino American Society of Architects and Engineers PE Civil CA (Issued July 27, 2007; Expiration Date: December 31, 2019)

Years with GHD: 3 | Home Office Location: Irvine

Professional Summary: Mr. Tortuya has experience in the design of flood control systems, ecosystem and wetlands restoration, erosion control, LID and HCOC design for storm water quality (MS4) compliance, hydrologic/hydraulic modeling, watershed management, flood plain management, and storm drain site design. He has experience in the design of backbone storm drain infrastructure, water quality NPDES Compliance, and large scale drainage projects including reservoirs, dams, levees, and flood attenuation basin design. He is an expert in

Project Manager Standard Plan Updates | Orange County Public Works, CA

Project Manager responsible for overseeing the updates to Orange County Standard Plans. This task order included converting Microstation CAD files to Autodesk, and reviewing the standards for revisions in the design. Revisions were based on knowledge of current design criteria in Transportation, Drainage, and Land Development design. Also included in the revisions were approaches to sustainability in design, and an evaluation of the standards in comparison to other agency standards such as Caltrans.

Project Manager Local Drainage Manual (LDM) Peer Review | Orange County Public Works, CA

Project Manager responsible for overseeing the peer review of the OC LDM. This task includes coordinating experienced hydraulic engineers and scientists to provide a third party peer review of the Local Drainage Manual Updates which were submitted in December 2017. GHD will provide a review with the County of resulting comments and make suggestions on how to incorporate/address the comments. This task order also included the coordination of a Peer Review by all 34 Cities in Orange County. GHD will compile all comments to be evaluated in a review with County staff in September, 2018. The revisions are scheduled to be implemented and a Final version of the LDM released to the public in December, 2018.

Project Manager La Palma Avenue and Richfield Road Storm Drain Improvement Project | City of Anaheim, CA

Project Manager of a storm drain system extension project. The project included grant funding requirements, including schedule, budget, and project costs. The primary objective of the project was stormwater capture

and groundwater recharge. As the designer of record, GHD is tasked to provide hydrology and hydraulic calculations to show annual capture of stormwater runoff. Also included in the scope is final design of the storm drain extension into the ground water recharge basin, and the design of a pre-treatment system that includes a full capture alternative. A secondary objective of the project was to alleviate flooding within the intersection of La Palma Avenue and Richfield Road. The project is scheduled to begin construction in the spring of 2019.

Assistant Project Manager Los Cerritos Channel Sub-Basin 4 Regional BMP and Diversion | Signal Hill, CA

Responsible for the internal supervision of production for plans, specifications, and estimates for a Design/Build Regional BMP and Diversion Structure. This project includes a road relocation, excavation/grading plan for an underground storage system which will store up to 130 ac-ft of storm water run-off, improvements to a regional flood control facility, and a storm water diversion system, hydrology and hydraulic calculations for the system, and permitting. Responsibilities included the quality control of the design, responsible Engineer for the plans, and coordination with the various sub-consultants on the project. Responsibilities also include providing a project schedule and meetings with stake holders to present, and review the project. GHD analyzed multiple channel low-flow configurations and presented alternatives detailing construction costs and environmental impacts. Based on the recommended improvements, GHD will prepare the final design plans, which include grading plans, storm drain pipe plan and profile, structural, and channel modifications. The project is scheduled to break ground November, 2016.



Larry B. Tortuya, PE

**Project Manager
Engineer's Opinion (second) of Probable Cost
for Lane Channel Improvement Project |
Orange County Public Works, CA**

As part of the On-call Services contract we hold with Orange County Public Works, GHD was tasked with providing the County with a second opinion on Engineer's Estimate and Quantities for the Lane Channel Improvement Project. This project included evaluating the 100% plans sheets, and quantifying all materials outlined in the QTO. It also included researching cost data and establishing unit costs for the Bid Items.

**Task Manger
Hydrology and Hydraulics Report/Plan Review
On-Call, City of Buena Park, CA**

Oversee reviews for the City of Buena Park of H&H plans, studies, and other exhibits submitted for entitlement application of new or re-development projects to conform to the Orange County Hydrology Manual and design standards.

**Project Manager
Storm Water Quality Management Plan Review
On-Call | City of Oceanside, CA**

Currently acting as Project Manager of Storm Water Quality Management Plans (SWQMPs) Review On-Call with the City of Oceanside Engineering Division for projects subject to the current San Diego Region NPDES MS4 Permit. Also developed, in conjunction with the GHD team, the City's BMP Design Manual and Storm Water Quality Management Plan templates to comply with the current permit. Additional responsibilities include City staff permit compliance training, consultation with CIP staff for evaluation of current/future projects.

**Project Manager
MS4 NPDES Permit Compliance Support
Services On-Call | City of Anaheim, CA**

The City of Anaheim is required to develop, implement, and refine programs identified in the Orange County's Drainage Area Management Plan (DAMP). Collectively these programs are referred to as Stormwater Permit Compliance Programs. As the permit evolves, the re-issuance often requires refinement to the permit requirements. This project includes providing the City of Anaheim with adequately trained and competent managers, administrative and data management staff to assist the City in interpreting the requirements and refinements in the NPDES Permit or permit compliance programs assist with data collection, and submittals to Orange County and the Regional Water Quality Control Board (RWQCB). Tasks also include assisting the City with grant applications, and design of innovative approaches to water quality compliance, such as regional BMP implementation.

**District Engineer, Flood Control Engineer
Tres Rios - Phase 3 Environmental Restoration
| Maricopa County, AZ**

As part of the project, responsibilities included providing civil engineering support to the Los Angeles Division of the South Pacific Division as part of the Genterra Consultants, Inc. team. On the Tres Rios project, Consultant was responsible for the preparation of design and contract documents for construction of Phase 3 of the Tres Rios ecosystem restoration project. The project extends 5.2 miles along the Gila and Salt rivers and included the restoration of critical riparian and wetland habitats that have been lost in the area. The project will improve more than 500 acres of cottonwood-willow-riparian corridors and open water-wetland marshes along the river. The team completed a DDR for the final design features and produced civil and landscape plans and specifications using SpecsIntact and cost estimates in MII.

**Task Manager
Irvine Community Development Company |
Irvine, CA**

Prepare Grading and Infrastructure Plans for Phase 1 responsible for overseeing the plan, specifications, and estimates production for the storm drain infrastructure of Planning Area 39. The project included the improvements of two reinforced concrete box systems, stream restoration and embankment protection for San Diego Creek, and a bicycle trail low flow water crossing. The Task Manager role included overseeing plan production and support during the construction of the project. Consultant contracted with the Irvine Company to prepare the grading and infrastructure plans for Phase 1 of the Irvine Apartment Community project, Planning Area 39. The project will provide approximately 1,750 apartment units, with parks and trails to serve the community.

Other related areas of interest

- Fluent in 2 languages. Tagalog and English
- IT savvy. Expert in Civil 3D, HEC-RAS, WSPGW, WMS, STORM, AES, FLOWMASTER, HY8, HDS5, XPSWMM, Arc GIS, Infracore 360.
- Memberships. FASAE, ASCE

Certifications/Trainings

- CA Registered Professional Engineer (2007)
- Envision Certified Professional (ENV SP)
- Certified Floodplain Manager (CFM)

Recognized

- Excellence in Teamwork Awards 2009, Client Service Award 2008



Nathan Towleron, PE, QSP/QSD, QISP

WQ Management Plan



Qualified: B.S. Chemical Engineering – Environmental Process, Oregon State University, 2006

Connected: American Society of Civil Engineers (ASCE); Environmental & Water Resources Institute (EWRI); American Public Works Association (APWA); Licensed Civil: CA (#C81643)
PE Civil CA (Issued May 29, 2013; Expiration Date: September 30, 2021)
QSP/QSD (Issued 2017)

Years with GHD: 4 | Home Office Location: Long Beach

Professional Summary: Mr. Towleron is a licensed professional engineer who has worked on a multitude of stormwater projects throughout Southern California. His expertise includes MS4 & Industrial General Permit compliance, Stormwater Pollution Prevention Plan (SWPPP)

development, hydraulic and hydrologic modeling, stormwater feasibility studies, BMP maintenance compliance, structural analysis, and construction oversight. Mr. Towleron specializes in the design of structural stormwater BMPs including bioretention/biofiltration, detention/retention/rainwater harvesting systems, hydrodynamic separators, and media filtration systems.

Project Engineer **Stormwater Quality Management Plan** **Review | City of Oceanside, CA**

Mr. Towleron is currently acting as expert reviewer of Stormwater Quality Management Plans (SWQMPs) on behalf of the City of Oceanside Engineering Division for projects subject to the current San Diego Region NPDES MS4 Permit. He also developed, in conjunction with the GHD team, the City's BMP Design Manual and Storm Water Quality Management Plan templates to comply with the current permit. Additional responsibilities include City staff permit compliance training, and consultation with CIP staff for evaluation of current/future projects.

Project Engineer **Richfield Road | City of Anaheim, CA**

Mr. Towleron performed alternatives and feasibility analysis for City of Anaheim area storm drain infrastructure. Analysis included dynamic modeling of storm drain network to minimize stormwater infrastructure and mitigate peak flow rates. The feasibility study analyzed multiple options for storm drain infrastructure improvement with an emphasis on obtaining grant funding through specific improvement characteristics.

Project Engineer **State College Blvd. Regional BMP | City of Anaheim, CA**

Mr. Towleron performed the analysis and feasibility study for conversion of existing sanitary sewer to regional stormwater BMP. Analysis included delineation of contributing watersheds, evaluation of available storage volumes, and design/hydraulics of connections to existing storm drain system.

Project Engineer **Ball Road Storm Drain | City of Anaheim, CA**

Mr. Towleron conducted the review and alternatives analysis of the City of Anaheim storm drain master plan. Analysis included dynamic modeling of storm drain network to minimize stormwater infrastructure and mitigate peak flow rates.

Project Engineer **Lambert Road WQMP | Orange County** **Department of Public Works, CA**

Mr. Towleron developed a Water Quality Management Plan for the Orange County Public Works bikeway project. Development included site evaluation, hydrologic analysis, and specification and design of stormwater BMPs in accordance with Orange County Model WQMP and U.S. EPA's Green Streets Handbook.

Project Engineer **Live Oak and Trabuco Canyon WQMP |** **Orange County, CA**

Mr. Towleron developed a Water Quality Management Plan for Orange County Public Works safety improvement project along rural highway in unincorporated Orange County. Tasks included specification and design of Green Streets stormwater BMPs, development of long-term operation and maintenance specifications, and WQMP document and appendices.

Project Engineer **Anaheim Alley Sewer Improvements |** **Anaheim, CA**

Mr. Towleron designed greenway stormwater BMPs as part of sewer improvement project for the City of Anaheim Department of Public Works. The project utilized grant funding based on stormwater volume



Nathan Towleron, PE, QSP/QSD, QISP

capture. He used Orange County stormwater methodology to design modified sand filters and permeable pavement to meet volume capture requirements.

Project Engineer Stormwater Permitting Compliance | ConAgra Foods | Azusa, CA

Mr. Towleron developed a Stormwater Pollution Prevention Plan (SWPPP) and provided guidance to client in transition from Notice of Non-Applicability to Notice of Intent in compliance with New Industrial Stormwater General Permit 2014-0057-DWQ.

Stormwater Design Engineer Otay Ranch Village 2 | Chula Vista, CA

Mr. Towleron provided specification and hydraulic design of Vortechs hydrodynamic separator as an end of pipe stormwater treatment solution in compliance with the San Diego County Municipal Stormwater Permit.

Stormwater Engineer Stormwater Permitting Compliance | Kraft Foods | Fullerton, CA

Mr. Towleron developed a SWPPP as part of compliance with the Industrial General Permit.

Project Engineer Stormwater Improvements | Morton Salt | Newark, CA

Mr. Towleron served as Engineer of Record for bioretention stormwater improvements at an existing industrial facility, utilized volume/flow-based design to conform to facility size constraints while still meeting provisions of the City's Municipal Regional Stormwater Permit.

Stormwater Engineer Jefferson at Platinum Triangle | Anaheim, CA

Mr. Towleron designed modular concrete underground infiltration sand filters for a 400-unit luxury multifamily residential site in Orange County. System requirements included design of sedimentation forebay and volume/flow-based analysis to provide both treatment and storage of the water quality volume. Underground design allowed maximization of site use while still meeting Orange County's stormwater quality and quantity regulations.

Stormwater Design Engineer Del Rey Apartments | Marine Del Rey, CA

Mr. Towleron designed multiple high-rate proprietary biofilters as treatment segment of multifamily development storm drain system. He performed hydraulic analyses for the proper design of inlet/outlet control features, biofilters media bed, and an

underdrain system. Site constraints required excessive burial depth and unique sloped slab design to meet structural and grading requirements.

Stormwater Engineer Broadway Neighborhood Greenway | City of Los Angeles, CA

Mr. Towleron provided design assistance to City of Los Angeles and local consulting firms on a 55,540 cu ft concrete stormwater infiltration vault for a pilot project in South Los Angeles. Requirements included a hydraulic analysis for overall system volume and design of integrated water quality sedimentation pond to meet requirements of City's Municipal Stormwater Permit.

Stormwater Engineer Civita Park | City of San Diego, CA

Mr. Towleron provided engineering expertise to local consulting firm on design and construction of a 98,670 cu ft underground modular concrete stormwater hydromodification vault for City of San Diego. Design included hydraulic analysis and design of integrated high-capacity overflow system along with structural review.

Stormwater Design Engineer Distribution Center | Amazon | San Bernardino, CA

Mr. Towleron provided consulting assistance to local engineering firm with the design of three large-scale underground corrugated metal pipe stormwater detention systems for high-profile industrial development. Design requirements included hydraulic analysis, structural evaluation, and soils analysis.

Recognized (Certifications/Trainings)

- Qualified Industrial Stormwater Practitioner (QISP)
- Qualified SWPPP Practitioner (QSP) / Qualified SWPPP Developer (QSD)

Presentations

- City of Oceanside SWQMP Template Training for the 2013 San Diego Region MS4 Permit, Oceanside, CA, January 2017



Matthew Winkelman

Digital Integration



Qualified: B.S. Civil Engineering, University of Washington, 2000.

Connected: Member of Water Environment Federation. Member of California Water Environment Association (Redwood Empire Section Board Member). Member of American Society of Civil Engineers.

PE Civil CA (Issued: July 23, 2009; Expiration Date: December 31, 2019.)

PE Civil WA (Issued: December 15, 2004; Expiration Date: August 29, 2021)

Years with GHD: 11 | Home Office Location: Santa Rosa

Professional Summary: Matt Winkelman is a Project Manager with GHD and has over 19 years of experience designing and managing municipal water resources projects. Project experience covers a wide range of assignments in planning, design, and project management, including: feasibility and infiltration/inflow studies, sanitary sewer master and management planning, hydraulic modeling, utility and pump station design and rehabilitation, regulatory compliance, funding assistance, and construction management. Mr. Winkelman's project

experience is described below.

Project Director | Stanly Ranch Wastewater Project | Napa, CA

Project Director for preparation of a Phased Wastewater Master Plan for Stanly Ranch and senior civil engineer for the design of a 2,800-LF HDD crossing under the Napa River bundling both a 6-inch sanitary sewer force main and 24-inch recycled water line and connecting to the Napa Sanitation District Soscol Water Recycling Facility.

Project Manager, Lead Project Engineer Eastside Trunk Sewer Phases 2 and 3 | City of Rohnert Park, CA

Project manager and lead civil engineer designer for the completion of the design documents for Phases 2 and 3: \$17 million, 12,600-LF, 18- and 24-inch diameter AWWA C905 sewer main project. Aside from pipeline design, project work included review of design criteria, hydraulic modeling, survey, field reconnaissance, update of the hazardous materials corridor study, permit review, and road rehabilitation design. Project challenges included difficult geotechnical conditions and the review and design of project-specific trench design based on the soil and groundwater conditions.

Project Manager | Browns Valley Trunk Sewer | Napa Sanitation District, CA

Project manager for the planning and design for a new 3-mile, 18- to 54-inch diameter trunk sewer located in West Napa. The project began with an alignment study and hydraulic assessment that resulted in the selection of the preferred alignment. Specific tasks for the alignment study included: preparation of an extended period simulation model utilizing synthetic hydrographs to approximate the effect of peak wet weather flows on the sewer collection system; and evaluation of various alignments based on several selection criteria, including hydraulics, environment, stakeholders, permitting, constructability, schedule, and cost. Design includes

trenchless crossing of Caltrans Highway 29 right-of-way, CEQA evaluation, Caltrans permitting, coordination with various stakeholders, and preparation of SRF funding documents.

Project Manager | Long Drive and Vicinity Sewer and Water Improvements Project | City of Santa Rosa, CA

Project manager for the replacement of sewer and water infrastructure in busy City roadways and Highway 12 (Caltrans). Sewer improvements include CIPP rehabilitation of sewer main and laterals within private property and trunk sewer improvements in busy City roadways.

Project Manager | Boyce Road Lift Station Project | Union Sanitary District, Fremont, CA

Project manager for project scoping and design to replace the District's existing Boyce Road Lift Station with a new 7.0-mgd lift station. The scoping effort included site layout alternatives, collaboration with the District, and recommendations for design features based on operational preferences and cost-efficiency. Project challenges included Bay Mud, high groundwater table, and the development of contract documents for construction within a small project site and adjacent to the existing lift station that needed to remain in operation until the new lift station was ready for operation.

Project Engineer | Sunnyside WWTF Project – Vernon Road Diversion | Lake Stevens Sewer District, WA

Following completion of the District's WWTF Feasibility Study, Matt worked as a project engineer for the development of contract documents for this \$4.9 million 5,500-linear foot, 36-inch diameter, PVC and DI sewer gravity main. During preliminary design, coordination with the Washington State Department of Transportation determined that the alignment for the



sewer main would not be permitted within the State's Highway 204 right-of-way. Working with the District, Matt identified an alternate alignment that included trenchless construction under Highway 204 and forested wetlands, through various County rights-of-way, and 11 private properties. Preparation of contract documents included: coordination with right-of-way and appraisal sub-consultants and various property owners for the acquisition of the private property easements and two right-of-way permits; coordination with environmental, geotechnical, and cultural resource sub-consultants to prepare permit and construction documents for various permitting agencies; jack and bore installation of 1,300-linear feet of 54-inch diameter casing under a wetland and State Highway; and the preparation and administration of project funding documents (\$54 million construction loan funding).

Project Manager | 20th Street SE Sewer Improvements Project | Lake Stevens Sewer District, WA

The Lake Stevens Sewer District is located about an hour north of Seattle, Washington and serves a population of approximately 40,000 people. Project management and lead civil engineering services included comprehensive planning, design, and project needs presentations to the District Commission for this \$2.5 million 4,000-linear foot, 15- and 24-inch diameter PVC and DI sanitary sewer main project. Project responsibilities also included: development and implementation of an Interlocal Agreement between the District and County; preparation of project scopes, budgets, and construction documentation; coordination with County engineering staff and geotechnical sub-consultant; and the acquisition of permits from the DOT and County.

Project Engineer | Coal Mines Trail Interceptor Project | City of Roslyn, WA

Design engineer services included design support and client coordination for this \$1.0 million, 7,000-linear foot, 12-inch diameter HDPE and PVC sanitary sewer main located within a recreational trail corridor. Project responsibilities included the preparation of plans, specifications, and estimates, coordination with geotechnical sub-consultant, Coal Mines Trail Commission, Bonneville Power Administration, and the City of Cle Elum.

Project Engineer | SW 7th Street Storm Drainage Project | Renton, WA

Project engineer services included lead design and construction management assistance to the City for this \$3.5 million, 5,500-linear foot, 36- and 60-inch HDPE and RCP diameter storm sewer main located in a heavily trafficked commercial corridor with multiple existing utilities and businesses. Project responsibilities included the preparation of contract documents,

coordination with utility location and geotechnical sub-consultants and the City's Project Manager. The project area had multiple utility conflicts that required relocation or redesign of the project alignment. As the project engineer, Matt coordinated with the City, business owners, and utility providers, including project team site visits to verify the pipeline alignment prior to the detailed design phase.

Project Engineer | Sewer System Management Plans (SSMP), Statewide | California Department of Corrections and Rehabilitation (CDCR), CA

Project engineer for the preparation of SSMP documents for 38 CDCR Institutions located throughout the state. The purpose of the project was to provide CDCR with standardized documentation and procedures to meet the requirements of the State's SSO Program. SSMP documents include evaluation and modification to various CDCR and Institution-specific programs, including: legal authority, operation and maintenance (O&M), Sanitary Sewer Overflow Emergency Response Plan (OERP), and fats, oils, and grease (FOG). Project work was coordinated with CDCR Headquarters staff and various personnel at each Institution.

Project Engineer | Sewer System Management Plan (SSMP) | United States Coast Guard, TRACEN Petaluma Facility, CA

Project engineer for the preparation of the SSMP for the Coast Guard base's sanitary sewer collection system.

Project Engineer | North Old Redwood Highway Area Utility Infrastructure Study | Town of Windsor, CA

This project included a comprehensive review of sanitary sewer, potable water, storm drainage, recycled water, and overhead utilities within a portion of the Town's designated redevelopment area. Project work included site reconnaissance, records review and data collection, close coordination with Town staff, various meetings and workshops with Town planning, engineering, and O&M staff, coordination with Sonoma County Water Agency, hydraulic evaluation, and preparation of recommendations for capital projects and funding.

Project Manager | Sewer Collection System Planning | Napa Sanitation District, Napa, CA

Project manager for various technical evaluations of the District's sewer collection system, including hydraulic assessment of the 16-mgd West Napa Pump Station.

WILLIAM D. BELLAMY



William Bellamy is an adjunct Professor of Practice and Deputy Director of the Center of Excellence in Produce Water Management at the University of Wyoming. Prior to joining UW, he had 40 years experience with organizations such as CH2M Hill, Texaco Inc, US Army Environmental Hygiene Agency, US EPA, as a professional design, operations, construction engineer and planner. He specializes in the application of sustainable facility development and assessment principles for government, municipal, and industrial clients, focusing on water treatment and quality issues.

Education

Ph.D., Civil (Environmental) Engineering, 1984, Colorado State University

M.S., Civil (Environmental) Engineering, 1974, University of Wyoming

B.S., Electrical (Bio-medical) Engineering, 1972, University of Wyoming

Overview of Work Experience

2014 to Present, Adjunct Professor of Practice, University of Wyoming – Current research activities include systems to provide safe drinking water, resource recovery from wastewater and energy production waters, economics of beneficial use. Current teaching has included Sustainability in the Built Environment, Senior Environmental Design, Intro to Environmental Engineering, and freshman Introduction to Engineering, and lectures on professionalism and decision making.

1984 to 2014, CH2M HILL; Fellow and Senior Vice President - Fellow and Senior Vice President of Water Technologies at CH2M HILL, a \$6 billion engineering planning, design, construction and operations company. He provided leadership and direction for the water business and application of technologies worldwide. He was instrumental in the development of innovative methods for assisting clients develop sustainable infrastructure projects which balance stakeholder input, economics, and environmental considerations. He provided engineering services including studies, designs, construction, and operations for clients, valued at over \$4 billion.

1978 to 1980, ARAMCO Inc., Dhahran, Saudi Arabia; Senior Environmental Engineer – Senior planner and environmental engineer for oil refining, distribution and marine facilities as well as project manager for various water, wastewater, and reuse projects. Project responsibilities included the development of designs and operating plans for RO treatment, seawater filtration, non-potable reuse, and assisting with the development of a new 5,000-person community. Served as the emergency response engineer for environmental incidences such as well fires and pipeline brakes.

1974 to 1978, Texaco, Inc., Port Arthur, Texas; Senior Process Engineer – Process engineering duties included technical supervisor of the wastewater treatment facility, and hazardous waste treatment and reclamation facility. Design, construction, and operations duties included hazardous and non-hazardous waste reclamation and landfill disposal facilities. Certified as a wastewater treatment operator by the State of Texas.

1971 to 2001, Environmental Hygiene Agency, US Army, Captain – Duties included conducting reviews of water and wastewater treatment plants and water quality on US military installations, as well as review of US Army positions on environmental subjects. Prior duties included 3 years as an infantry officer (1966 to 1969).

William Bellamy 303-807-2195 wbellamy@uwyo.edu

Research Grants and Projects

Participation in research grants and projects include grant procurement and management as principle investigator (PI) or in a significant participatory role.

- Senior advisor for the study of biological treatment for removal of nitrate including two types of heterotrophic reactors and one autotrophic reactor using hydrogen as the energy source, Water Research Foundation.
- Greenhouse Gas Emission Inventor Guidance, Specialty Protocol Development, and Management Strategies for Water Utilities, Senior Advisor and co-author, WRF.
- Treatability of Algal Toxins Using Oxidation, Adsorption, and Membrane Technologies, Co-Principle Investigator, AwwaRF and Saint John's Water Quality District, FL.
- Ultraviolet Light Disinfection of Surface Waters, Co-Principal Investigator, with AwwaRF and City of Winnipeg.
- Surrogate Indicators for Treatment Plant Evaluations, Co-Principal Investigator, AwwaRF.
- Full-Scale Ozone Contactor Evaluations, Principal Investigator, AwwaRF.
- Backwash Waste Recycle Impacts of Potable Water Treatment Efficiency, Co-Principal Investigator, AwwaRF.
- Implementation of the Integrated Disinfection Design Framework, Co-Principal Investigator, AwwaRF.
- Addressing Operational Impacts of Enhanced Coagulation/Enhanced Softening, Co-Principal Investigator, AWWA and AwwaRF.
- Integrated Disinfection Design Framework (IDDF), Principal Investigator, AwwaRF.
- Capital Planning Strategy Manual, Contributing Author, AwwaRF.
- *Giardia* Treatment Efficiency of Slow Sand Filtration, U.S. EPA project conducted at Colorado State University, Project Engineer.
- *Giardia* Treatment Efficiency of Diatomaceous Earth Filtration, U.S. EPA project conducted at Colorado State University, Project Engineer.
- Atmospheric Monitoring and Data Analysis of Hydrogen Sulfide, State of Wyoming project, University of Wyoming, Principal Investigator, State of Wyoming.

Applications Research for Utilities and Municipalities

Participated in over 40 municipal and industry research and study activities. Projects resulted in the development of several new treatment technologies and significant reduction in capital and operating costs. In each case, regulatory compliance was an important component.

Board Appointments

- Board member Iofina Inc., chemical company, 2014 to present
- CH2MHILL Foundation, Board Member, philanthropic foundation, 2012 to 2015
- Colorado Water and Energy Consortium 2010 to 2016

Professional Advisory Boards and Committees

- Advisory Board Member, Center for Advanced Energy Studies (CAES), Idaho Falls Idaho (consortium of Idaho State, Idaho, Boise State, Wyoming University and Idaho National Lab) 2015 to 2018
- Drinking Water Subcommittee, Board of Scientific Counselors (BOSC), to USEPA, 2010 to 2012
- Science Advisory Board, USEPA, Homeland Security Advisory Committee 2005 to 2010
- National Advisory Board, University of Wyoming, College of Engineering 2002 - 2010
- International Experts Committee, Sydney Water Corporation 1999 and 2003, Sydney, Australia
- National Drinking Water Advisory Council, USEPA, 1998 to 2000

- U.S. EPA appointment to National Drinking Water Advisory Committee, Co-chairman of Working Group on Research Prioritization, 2000
- Co-chairman of AwwaRF and EPA's experts workshop on Microbial and Disinfection Byproduct Research Needs, 1999
- Technical Committee member for EPA and AwwaRF Disinfection and Disinfection Byproducts Council, 1997 to 2002
- Chairman Blue Ribbon Expert Panel, Impacts of Recreation on Drinking Water Supplies, Metropolitan Water District Southern California, 1995
- Co-chairman for AwwaRF and EPA Research Prioritization, 1996

Representative Engineering Studies, Designs, and Construction Activities

The following is representative of involvement in over 150 water projects totally over \$4 billion.

- Project lead consultant for the investigation of desalination, solar power enhancements, and conveyance of water for Riyadh Master Planning which included potable water for 9 million, regional sustainable agriculture, 800 km conveyance, and reuse opportunities (2013).
- Senior consultant for Master Planning of the water treatment and distribution system, City of Longmont Colorado, 2012
- Senior consultant for the study of ozone application and implementation at the 120 mgd Crescent Hill Water Treatment Plant for the Louisville Water Company.
- Lead technologist and consultant for the expansion of the Dublin Road Water Treatment Plant for Columbus Ohio. 80 mgd with additions of ozone, granular activated carbon filters (BAC), ion exchange for nitrate and improvements to chemicals, flocculation, sedimentation, lime soda softening and recarbonation processes.
- Lead consulting engineer for the preliminary design, build, and operate, 100 mgd membrane water treatment plant for San Diego County Water Authority. Process train included, direct membrane filtration, ozone, BAC filtration. (2005 to present)
- Senior Project Advisor and Consultant for the Southern Nevada Water Authority disinfection byproducts study, including advise and direction on regulations, decision making techniques, and technologies.
- Member Experts Panel assessing current and future CIP development for Metropolitan Water District of Southern California
- Managing Engineer for the \$2.2 billion (Public Works and Water) Iraqi reconstruction program.
- Project Director for design of 100 mgd water treatment plant, presedimentation, enhanced coagulation, ballasted clarification, ozone, GAC filtration, Albuquerque Bernalillo County Water Authority, NM.
- Senior consultant and lead process engineer for the design of 120 mgd UV disinfection system for the City of Winnipeg, Canada, as well as the conceptual design of the advanced water treatment plant consisting of enhanced coagulation, DAF, ozone, GAC filtration, UV.
- Senior technologist for the design of the 180 mgd ozone and UV disinfection facilities for Seattle Public Utilities (1999-2002)
- Senior consultant for the development of distribution system early warning system, City of Anaheim, CA (2002)
- Senior consultant for the study and design of water treatment facilities including UV for the City of Henderson, NV (1999-2002)
- Senior Technologist for 30 mgd arsenic water treatment plant, enhanced coagulation, clarification, filtration, El Paso, TX (2002-2004)
- Senior consultant for the upgrade and expansion of the 20 mgd water treatment plant; enhanced coagulation, ballasted clarification, ozone, biofilters, Melbourne, FL

Over 100 Presentations and Papers



Emily L. Owens-Bennett, P.E., BCEE
Trussell Pasadena Office

EDUCATION

- M.S. Environmental Engineering, Master's International Program, *Michigan Technological University, Houghton, Michigan*
- B.A. Environmental Studies-Geology, French minor *Whitman College, Walla Walla, Washington*

REGISTRATION

Civil Engineer, State of California - No. 78720
Issued: 6/10/11 Exp: 9/30/20

CERTIFICATION

Board Certified Environmental Engineer,
American Academy of Environmental Engineers –
No. 19-10007 Issued: 11/8/19 Exp: 12/31/20

SUMMARY

Emily Owens-Bennett is a Supervising Engineer with more than 10 years of water quality and treatment project experience with Trussell Technologies. Ms. Owens-Bennett has been involved in projects spanning a wide variety of applications, including assessment of source water quality for new drinking water projects, implementation of rigorous water quality monitoring programs aimed at demonstrating regulatory compliance for future full-scale facilities, characterization and laboratory investigation of solids in a brine wastewater matrix, seawater desalination through the use of UF/RO and the application of preformed chloramines, a study of the seawater quality impacts of red tides and stormwater inputs, pilot project field monitoring and water quality analyses, sampling and maintenance of soil columns replicating groundwater water quality and contaminant attenuation (synthetic organic compounds, microbes, nutrients, etc.), routine laboratory water quality analyses associated with a variety of water and wastewater treatment applications, investigation and pilot treatment of groundwater odor issues, bench-scale testing of advanced oxidation processes (solution ozone test and collimated beam testing), and the development of point-

of-use (POU) water treatment technologies.

PROJECT EXPERIENCE

East Valley Water District

Plant 134 Disinfection Byproduct Investigation

Year: 2019

As part of a diverse water supply portfolio, East Valley Water District (East Valley) treats surface water from the State Water Project (SWP), as well as local surface water from the Santa Ana River at the Plant 134 Water Filtration Facility (Plant 134). The current treatment train for Plant 134 includes coagulation, membrane filtration, and chlorination. Seasonal water quality changes in the two surface water sources for Plant 134 have historically resulted in elevated concentrations of disinfection byproducts (DBPs), namely trihalomethanes (THMs), in certain areas of the East Valley distribution system. In response to an exceedance of the regulatory limit for total THMs, East Valley submitted a Corrective Action Plan (CAP) to the State Water Resources Control Board Division of Drinking Water (DDW) in June 2017. Trussell Tech was retained to investigate DBP formation and optimize treatment at Plant 134 for the removal of DBP precursors from the SWP source water, which historically has higher bromide concentrations. Trussell Tech conducted bench-scale tests comparing the effectiveness of three coagulants—ACH, aluminum sulfate, and ferric chloride—at three target pH conditions, for DBP precursor removal. Simulated distribution system (SDS) THM formation of the coagulated/filtered water was tested for quantitative comparison of DBP formation. The bench-testing results showed that pretreatment with ferric and sulfuric acid (to a pH of 6.5) yielded the lowest DBP levels and can be used to improve DBP levels within the EVWD distribution system.

Role: *Project Manager*

Mesa Water District

Free Chlorine Conversion Study

Year: 2018 to present

The Mesa Water District (Mesa Water) is considering converting its clear groundwater wells from chloramines to free chlorine disinfection and engaged Trussell Tech to complete a phased Free Chlorine Conversion Study. To avoid issues with disinfection byproduct (DBP) formation, two of Mesa Water's sources, amber-colored groundwater treated at the Mesa Water Reliability Facility (MWRF) and supplemental imported water provided by the Metropolitan Water District of Southern California (Met) would continue to be chloraminated. Owens-Bennett led a technical evaluation of the feasibility of the chloramine to free chlorine residual conversion for the clear groundwater wells through bench testing blended water scenarios of free chlorinated clear well groundwater with chloraminated

MWRF and Met waters. A feasibility assessment included hydraulic modeling by Carollo over a range of operating scenarios to confirm locations of potential problematic blends in the system. Owens-Bennett contacted a number of local drinking water utilities that currently operate with a blend of free chlorinated groundwater and chloraminated imported water from Met in a single distribution system pressure zone. A full-scale testing program has been developed and reviewed by the California State Water Resources Control Board Division of Drinking Water. This testing will pave the way for permanent system conversion.

Role: *Project Manager*

West Yost Associates – Stanislaus Regional Water Authority

Regional Surface Water Supply Project

Year: 2016 – Present

Driven by historic drought conditions, degradation of groundwater supplies, and declining groundwater levels, the Stanislaus Regional Water Authority is seeking to develop a reliable supplemental surface water supply. Trussell Technologies is part of the Program Management team, guiding and performing technical work to inform decisions regarding the proposed Surface Water Treatment Plant Project. Owens-Bennett has worked on the source water evaluation, including review of historical water quality data, development and oversight of the sampling program, and working with California's Division of Drinking Water to gain approval for source water monitoring, including Bin classification per LT2ESWTR regulations. Owens-Bennett completed a bench-scale testing program to evaluate treatment alternatives, including enhanced coagulation via jar tests, ozonation using solution ozone testing, DBP formation, as well as process performance, including manganese removal.

Role: *Project Engineer*

Goleta Water District

Bench-Scale Pretreatment Evaluation

Year: 2017

The Goleta Water District (District) treats surface water from Lake Cachuma, a reservoir fed by local runoff and dechloraminated State Project Water from the Sacramento-San Joaquin River Delta, at the Corona Del Mar Water Treatment Plant (CDMWTP). Lake Cachuma was influenced by runoff associated with above-average rainfall in early 2017, as well as a watershed impacted by fire, resulting in elevated total organic carbon (TOC) concentrations in the CDMWTP feed water. The District increased its prechlorination dose to prevent algae growth in the CDMWTP sedimentation basins, however elevated levels of total trihalomethane (TTHM) were

measured in the CDMWTP effluent and within the distribution system. Trussell Technologies was retained to conduct bench testing to evaluate ozone and chlorine dioxide as alternative pretreatments to replace prechlorination at the CDMWTP. The bench test evaluation was completed in the Trussell Technologies Lab in Pasadena, CA and included: assessment of CDMWTP influent water oxidant demand for ozone, chlorine dioxide, and free chlorine; simulation of the CDMWTP treatment process; assessment of disinfection byproducts (DBPs) – TTHM, haloacetic acids (HAAs), bromate, chlorite, and chlorate – formed over a maximum distribution system residence time of 6 days.

Role: *Project Manager*

Mesa Water District

Title: Water Quality and Compliance Supervisor

Date: 2014-2015

Mesa Water District (Mesa Water) retained Owens-Bennett for five months as a full-time consultant working in the capacity of Water Quality and Compliance Supervisor within their Operations Department to provide support for the position on a temporary basis, while recruiting a permanent employee. Responsibilities of this position included oversight of water quality and cross-connections staff, including implementation of the District's monitoring plan, working with operators to enact operational changes in response to water quality measurements, regulatory compliance reporting, capacity building through cross-training on water quality and sampling, coordination with operators, maintenance staff, and the District's Engineering Group, as well as training the permanent hire on job-related tasks during a three-week transition period. Mesa Water predominantly uses local groundwater from five clear wells and two amber-colored wells that are treated at the Mesa Water Reliability Facility using a combination of nanofiltration, air stripping, and odor polishing. All water within the Mesa Water distribution system is chloraminated at the source wells, and supplemental disinfection boosting is implemented, as needed, at the reservoirs for improving chlorine-to-nitrogen ratios and controlling nitrification.

Role: *Project Manager*

Western Municipal Water District

Western Riverside County Regional Wastewater Authority Plant Expansion – Chlorine Contact Basin Tracer Study

Year: 2017

Demonstrated to the State Water Resources Control Board Division of Drinking Water the modal contact time of the chlorine contact basins for the WRCRWA plant

expansion project. Developed a test plan; obtained test plan approval from DDW; prepared for and conducted tracer tests with team; analyzed results; prepared final report; and obtained approval from DDW.

Role: *Project Manager*

James H Borchardt PE

Water Treatment Technical Director



Jim has 40 years of experience in project management and engineering for water treatment, conveyance, and storage facilities. He is an award winning water treatment expert and a contributing author of the MWH Water Treatment Principles and Design Text Book (3rd Edition) that is used to teach water treatment in universities across the country. Jim has managed water quality studies, bench and pilot scale testing, facility planning and design, process evaluation, site development, hydraulic analysis, treatment plant design, construction management, and startup and operation on more than 125 treatment facilities. Jim has also served as technical advisor on more than 250 other treatment projects.

EDUCATION

Bachelor of Science, Civil Engineering, Colorado State University, Fort Collins, Colorado, 1976

Master of Science, Environmental Engineering, University of North Carolina, Chapel Hill, North Carolina, 1979

CERTIFICATIONS & TRAINING

Awards, 2006 Engineer of the Year in Santa Barbara County

REGISTRATIONS

Registered Professional Engineer #21603, State of Nevada

Registered Civil Engineer #17847, State of Colorado

Registered Civil Engineer #35819, State of California

MEMBERSHIPS

Member, WaterReuse Association

Member, Water Environment Federation

Member, International Ozone Association

Member, American Water Works Association

Member, Chi Epsilon National Civil Engineering Honor Society

Member, American Membrane Technology Association

Member, American Society of Civil Engineers

OFFICE LOCATION

Pasadena, CA

PROJECT EXPERIENCE

Weymouth WTP Filter Rehabilitation Design and Construction, Los Angeles, California (Project Manager), 2007-2017

Client: Metropolitan Water District of Southern California (MWD)

The Weymouth WTP is a 520-mgd plant with 48 dual-media gravity filters. Initially, Jim oversaw the rehabilitation of four filters, each with an individually different filter design. The four filters were studied for two years to determine the best design for long-term performance. After the optimum design was determined, all 48 plant filters were rehabilitated in a \$35M construction project. The design included media and underdrain replacement, and new surface wash and wash troughs, raising the concrete gullet walls, hatch and connection replacement, new handrails, and instrumentation.

Green River Filtration Facility, Tacoma, Washington (Principal-in-Charge), 2012-2016

Client: Tacoma Water

Jim was the principal-in-charge of this \$180 million new treatment plant project. The facility is constructed on the site of the existing Green River Headworks, and treats water from both the Green River and from groundwater supplies delivered from the North Fork Wellfield. The initial maximum filtration capacity of the new facilities is 150 mgd with an ultimate filtration capacity of 168 mgd. The Green River Filtration Facility is a hybrid facility,

James H Borchardt PE

Water Treatment Technical Director

with a capacity of 90 mgd operating in conventional treatment mode (with clarification preceding the filters), and full capacity operating in direct filtration mode. Turbidity in the Green River varies widely, ranging from less than 1 NTU in the summer to over 500 NTU during winter storms or reservoir flushing operations. The solids treatment facilities include mechanical dewatering to provide reliable, year-round ability to process solids in preparation for final disposal. Jim provided support for the pilot testing of alternate filter media combinations, which led to approval from the state to design the plant at a 10 gpm/sf filtration rate.

Advanced Water Treatment Demonstration Facility, Los Angeles, California (Project Manager), 2016-2019

Client: Metropolitan Water District of Southern California

Jim serves as project manager for the 0.5 mgd Advanced Water Treatment Demonstration Facility, proposed as a partnership between the Metropolitan Water District of Southern California and the Los Angeles County Sanitation Districts. The AWTDF will provide biological NdN treatment with MBR, followed by traditional RO-UV/AOP treatment on secondary effluent from the 400-MG Joint Water Pollution Control Plant, to investigate treatment needs for indirect potable reuse. The goal of the project is to obtain DDW approval for log removal credits for MBR. In related studies, full-scale facilities of up to 340-mgd have been modeled and cost estimates prepared to support the Regional Recycled Water Supply Project.

Jensen Solids Handling Facilities Project, Granada Hills, California (Technical Director), 2005-2017

Client: Metropolitan Water District of Southern California (MWD)

Jim served as technical director for the solids handling facilities project at the 750-mgd Jensen Water Treatment Plant. He was responsible for

managing all technical aspects of the project, including concept development, discipline engineering, and presentation of results. Project facilities included new equalization, thickening, four pump stations, temporary and permanent lagoons, four 2-meter belt presses, and storage hoppers for processing up to 40 tons of dry weight solids per day.

Water Treatment Plant Expansion and Disinfection-By-Product Control Project, Antelope Valley, California (Project Manager), 2004-2010

Client: Antelope Valley East Kern Water Agency

Jim led the planning and pilot studies, through detailed design services, construction support, and start-up for the expansion and upgrade of four WTPs. These plants ranged in size from 4 to 90 mgd. The four treatment plants (Quartz Hill, Eastside, Acton, and Rosamond) were upgraded to include intermediate ozonation, deep-bed GAC filtration, and chloramines. The work required coordination of three main contractors and more than a dozen equipment suppliers. The project emphasis on schedule control was critical to allow coordinated conversion of the distribution system residual. Standby disinfection was also provided with the addition of chlorine contact basins. In addition, the largest treatment plant was expanded to 90 mgd by the addition of plate settler modules and new sludge removal mechanisms to the existing sedimentation basins. Jim also provided final start-up and commissioning services.

Design Manager, Corona Del Mar WTP Upgrades and Modifications, Goleta, California 2006-2009

Client: Goleta Water District

Jim managed the design under a design-build contract for the extensive upgrades and modifications to an existing 30-year-old, 36-mgd conventional surface WTP. The design team's work included hydraulic flocculation, pumped flash mixing, reconfiguration of the sedimentation

James H Borchardt PE

Water Treatment Technical Director

basins, filter-to-waste, new chemical storage and feed systems, and a new LEED® certified laboratory/administration/control building. Jim was nominated by the District and received the Engineer of the Year Award in Santa Barbara County for this work and the project received the Achievement Award for the Best Infrastructure Project under \$50M.

Technical Lead, Recycled Water Seasonal Storage Facility Plan of Action and Basis of Design, 2014-2016

Client: Las Virgenes – Triunfo Joint Powers Authority

Jim led the JPA Board, project stakeholders, and Stantec team through a facilitated public workshop process to develop and evaluate six conceptual project alternatives. The JPA Board selected two scenarios for further investigation and established a Plan of Action for development of a project. The subsequent Basis of Design provided detailed evaluation of the two scenarios and continued the process of stakeholder engagement, four public workshops, and technical analysis. The conceptual scenarios were refined into two specific project alternatives, each with strong stakeholder support. On August 3, 2016, the JPA Board of Directors voted to explore Potable Reuse using surface water augmentation in the Las Virgenes Reservoir as the preferred option to address seasonal storage.

Sustainable Water Infrastructure Project (SWIP), Santa Monica, California (Project Manager), 2016-2019

Client: City of Santa Monica

Jim managed the planning and conceptual design of the SWIP project and is now leading Stantec's team as Owner's Engineer on this progressive design-build project. SWIP was created to help the City to achieve its long-term goal of water sustainability and drought resilience by using all of its local water resources, including stormwater

runoff, recycled municipal wastewater, and brackish groundwater. The SWIP combines each of these sources to produce approximately 1,680 AFY of advanced treated water for City use in lieu of imported water supply. The SWIP will produce water of advanced treated quality that, when properly permitted, will be acceptable for potable reuse via replenishment of the City's natural groundwater aquifers. Until final permits are obtained, the SWIP water will be used to meet existing recycled water demands.

CS-879 Sunol Valley Water Treatment Plant Improvements Project, San Francisco, California (Technical Advisor)

Client: San Francisco Public Utilities Commission

Jim served as technical advisor on multiple phases of improvements to the 160-mgd Sunol Valley WTP. The initial \$50M project lifted a regulatory compliance order and increased peak capacity to 160 mgd. Improvements included replacement of all filter valves, new filter-to-waste facilities, new chemical feed facilities, a new water quality laboratory, modification of the plant control building and maintenance shops, and seismic strengthening of all plant structures. A subsequent project will increase peak capacity to 200 mgd by adding a new 40-mgd flocculation/sedimentation basin, a new 3.5-MG chlorine contact tank, and a 17.5-MG circular storage tank; and upgrading the plant's existing filters with new filter media, new underdrains, and air/water backwash capability. Upgrading the plant's 12 existing filters and increasing filtration rates to 8 gpm/sf saved the SFPUC \$18 million, compared to building 4 new filters operating at 6 gpm/sf. Stantec prepared the high rate test plan, conducted training of plant staff, analyzed performance data, and obtained operating permit approval.



Mr. Cruz is a registered Civil Engineer and a Vice President at SPI. He has experience in the design of water, wastewater and water reuse facilities. His assignments have included detailed design, pilot testing, equipment procurement, equipment selection, life-cycle evaluations, feasibility studies, and construction services. He has experience with advanced treatment technologies and equipment including membrane filtration, membrane bioreactors, ozone, reverse osmosis, granular activated carbon, and UV as well as conventional water treatment technologies.

EXPERIENCE

Water Treatment

KETTLEMAN CITY COMMUNITY SERVICES DISTRICT

Surface Water Treatment Plant Project, Kettleman City, CA (2009–Present)

Project Manager – Mr. Cruz is the project manager for the membrane filtration component of a 1.3 mgd surface water treatment plant. The plant will produce drinking water by treating California Aqueduct water. He oversaw the planning, construction, and operation of a 3 month pilot study for the project which included membrane system pilot testing, conventional water treatment plant evaluation, and a disinfection by-product mitigation evaluation. He prepared plans and technical specification for the membrane filtration system. During construction, Charles will provide contract administration for the selected Pall microfiltration system as well as installation, commissioning, start-up, training, and operations assistance services.

SWEETWATER AUTHORITY

Electronic O&M Manual Project, Chula Vista, CA (2011- 2018)

Project Manager – Charles was the project manager for a five year project involving design, content development, installation, and integration of an Electronic O&M Manual for all of Sweetwater Authority's facilities. Facilities included three water treatment plants, wellhead treatment facilities, and distribution system facilities including numerous pump stations and storage tanks. Activities included coordination of software development sub consultants, development of O&M content, deployment of O&M content, and training of Sweetwater Authority staff for content management and general use of the Electronic O&M Manual.

SWEETWATER AUTHORITY

Lockout/Tagout Procedures Project, Chula Vista, CA (2011–2018)

Project Manager – Charles served as the project manager for a five year project involving development of lockout/tagout procedures for all of Sweetwater Authority's facilities. Facilities included three water treatment plants, wellhead treatment facilities, and distribution system facilities including numerous pump stations and storage tanks. Activities included conducting field visits in conjunction with Sweetwater Authority safety and operations staff to collect information for development of lockout/tagout procedures, and production of electronic lockout/tagout procedures.

SOLANO IRRIGATION DISTRICT

Pleasant Hills Water Treatment Plant Project, Vacaville, CA (2009 – 2017)

Project Manager – Charles was the project manager for procurement and design of a 150 gpm packaged Pall microfiltration system. The treatment system employs direct filtration followed by chlorination to treat surface water for drinking water

Education:

B.S., Chemical Engineering,
Stanford University, 1985
M.S., Civil Engineering,
Stanford University, 1992

Registrations/Certifications:

Professional Engineer,
Civil, California, C59845, issued
7/23/1999, expires 12/31/2021

Professional Affiliations:

Water Environment
Federation

Employment History:

Separation Processes, Inc. -
2005- to Present
CDM, Inc. – 1995 to 2005,
1991 to 1993
Dow Chemical, U.S.A. –
1985-1990

Areas of Expertise:

MF/UF Treatment
Design/Construction
MF and MBR Procurement
Advanced Water Treatment
Water Reuse
Membrane Bioreactor

Years of Experience: 34

Years with SPI: 17

Office Location:

Carlsbad, CA



use. Provisions for coagulant addition upstream of the membranes will be provided to assist with Total Organic Carbon removal.

METROPOLITAN WATER DISTRICT OF SOUTHERN CALIFORNIA

Weymouth Water Treatment Plant Oxidation Retrofit Program, La Verne, CA (2014-2016)

Sr. Project Engineer – The Weymouth Water Treatment Plant is a 520 mgd surface water treatment plant. The Oxidation Retrofit Program included the addition of pre-ozonation ahead of the conventional water treatment process. Mr. Cruz prepared commissioning manuals for retrofit equipment including ozone system ancillary equipment, washwater pumps, chemical systems, life and safety systems and plant utilities.

TURLOCK IRRIGATION DISTRICT

Regional Surface Water Supply Project, Turlock, CA (2006–2007)

Project Manager – Charles served as the project manager for membrane filtration pre-design activities for a 40.5 mgd surface water treatment plant. He prepared a detailed process analysis that reviewed conventional flocculation/sedimentation, high rate clarification, membrane filtration, media filtration, ozone, GAC and UV processes. Charles also oversaw the membrane filtration component of a nine month pilot testing program for the project which included development of the membrane pilot system protocol. He developed the membrane filtration section of the preliminary design report for the project.

CITY OF SCOTTSDALE

CAP Water Plant Expansion, Scottsdale, AZ (2005–2006)

Project Manager – Charles developed preliminary design documents for the membrane filtration component of the 30 mgd CAP Water Treatment Plant Expansion as well as the detailed procurement documents for the membrane system.

GLOBAL WATER

Maricopa Groves and Terrazo Water Treatment Plant Feasibility Study, Maricopa, AZ (2005–2006)

Project Engineer – Charles prepared a detailed process analysis of two 5 mgd water treatment plants treating CAP water for potable use. The process analysis reviewed conventional flocculation/sedimentation, high rate clarification, membrane filtration, media filtration, ozone, GAC and UV processes. The evaluation determined the standard processes to be used in both facilities.

CITY OF SANTA MONICA

Sustainable Water Infrastructure Project (SWIP) Advanced Water Treatment Facility (AWTF), Santa Monica, CA (2018-Present)

Project Manager – Charles is leading membrane procurement support efforts for the MBR and reverse osmosis components of a 1 mgd indirect potable reuse facility. The facility will be located in a subterranean structure and will operate as a scalping plant to treat a blend of municipal wastewater and stormwater runoff for indirect potable and non-potable reuse. Activities include assistance to the progressive design-build team for design criteria development, procurement specification review, and bid evaluation.

CITY OF POST FALLS

Post Falls Water Reclamation Facility Tertiary Treatment Improvements, Post Falls, ID (2016-Present)

Project Manager – Charles is the project manager for membrane filtration pre-design and procurement activities for a tertiary wastewater treatment system. The existing 5.2 mgd average/8.8 mgd peak water reclamation facility will add tertiary treatment to achieve ultra-low phosphorus removal for regulatory compliance and recycled water use. He led the supplier prequalification and membrane filtration equipment procurement efforts. The membrane filtration system will be designed to accommodate membranes from at least two different membrane module suppliers. Charles also oversaw the membrane filtration component of a six month pilot testing study to evaluate high rate clarification and membrane filtration. He led the membrane pilot design, construction, operation, data evaluation, and pilot study report efforts.



Kirill Dolinskiy, PMP

Project Manager/ Scheduling/ Document Management

SUMMARY

Mr. Dolinskiy has more than twenty years of program and project management, risk and change management, governance, compliance audit, and engineering experience (USA and International).

Below are the key elements of Mr. Dolinskiy's expertise:

- Program Management
- Project Management
- Governance and Compliance Audit
- Project Controls
- Program/ Project Delivery Models
- Risk Management
- Change Management
- QA/QC Management
- Contract Management
- Document Management
- Design Management
- Engineering Services during Construction
- EPC Management
- Construction Management
- Conflict Resolution

EDUCATION/ CERTIFICATIONS:

M.S. in Civil and Environmental Engineering, University of Pittsburgh, Pittsburgh, PA

B.S in Civil Engineering, Chelyabinsk State Technical University, Chelyabinsk, Russia

Project Management Professional (PMP Number: 1584705); Expiration Date – 3/13, 2022

HOME OFFICE

630 South Indian Hill Boulevard, Suite 1, Claremont, California 91711

YEARS WITH THE COMPANY – 6 years

2019- Current
Inland Empire Utilities Agency (IEUA)
CIP Program Project Control Services
Principal-In-Charge/ Project Manager

Mr. Dolinskiy served as a Principal-In-Charge and Project Manager for the Engineering Department-wide CIP program. The services include developing

the Department-wide project control (scheduling and cost estimating) policies and procedures, project management SOPs, claim management and reporting protocol.

2019 - Current
City of Beverly Hills, CA
Reverse Osmosis (RO) Water Treatment Plant
QA/QC Reviewer

Mr. Dolinskiy is responsible for technical and constructability review of the design of the City's Reverse Osmosis Water Treatment Plant improvements. The improvements were triggered by a decrease in source well capacities and challenging source well water quality. The improvements consisted of addition of sand separator system, an oxidation media filter (OMF) process, upgrade of RO system and membranes to increase facility reliability, operability, and to operate at maximum flow capacity, upgrade of the existing facilities to include new chemicals required for the oxidant media filtration process and improve existing chemical systems, modification of the control system to incorporate new pre-treatment processes and provide automated monitoring of RO performance, as well as changing wellhead facility control from flow control to pressure control to limit plant unexpected shutdown

2017 - 2019
Inland Empire Utilities Agency (IEUA)
CIP Program Management Assistance
Principal-In-Charge/ Project Manager

Mr. Dolinskiy served as a Principal-In-Charge and Project Manager in assisting Agency to execute 10-year \$750MM CIP engineering infrastructure (pipeline and pumps stations) and treatment plants expansions projects to assure executing efficiency, schedule and cost compliance. Mr. Dolinskiy assists Agency's Engineering Department with the development of the department's organizational structure, development of the department-wide project management procedures, risk and change management protocol, reporting and document management requirements, as well as standards and procedures for project controls consisting of



scheduling, cost estimating, and claim management.

2017 - 2019
Coachella Valley Water District (CVWD)
Program Management Support
Program Manager

Mr. Dolinskiy served as a Program Manager assisting District in execution its \$110M engineering CIP consisting of various pipeline, pump stations, state loans and grants and consolidating projects. In addition, Mr. Dolinskiy provided support to CVWD Engineering Department in development of project control scheduling methodology, as well as developing program and project management operating procedures.

2016
City of San Diego Pure Water Program
Risk/ Change/ Quality Control and Quality Assurance Manager

Mr. Dolinskiy served as Risk, Change and Quality Manager at the City of San Diego \$3.6B Pure Water Program, which is a phased, multi-year program that will provide 1/3 of San Diego's water supply locally by 2035. Mr. Dolinskiy was responsible for establishing the overall methodology, policies, business processes and procedures that will be put in place to manage program and project-specific risks, changes and quality; training all program and project team members on the requirements established in the program's Risk, Change and Quality Management Plans; running analyses on the program and project-specific risks to identify highest risks and determine whether adequate contingencies are available to address those risks; and performing program and project-specific audits to monitor compliance with all program policies, directives, business process procedures and standards.

2012 –2015
Altalink, Calgary, Canada
PMO Governance. Stage Gate and Risk Manager, Audit Compliance Manager

Mr. Dolinskiy served as Governance/ Stage Gate and Risk Manager at Altalink, L.P. – a power

transmission Calgary-based company. As a part of a \$7B Altalink's infrastructure upgrade, Mr. Dolinskiy was responsible for development, implementation and improvements of a project governance framework, Projects Delivery Model (PDM), KPIs, and change and risk procedures to ensure program's compliance with industry best practices and PMI standards. In addition, Mr. Dolinskiy developed and ran the stage gate framework process to assure that each project meets pre-determined criteria to advance to the following execution stage. Mr. Dolinskiy successfully guided projects with a total value of over \$5B for governance, corporate and industry standards compliance and served as a liaison between the project's teams and Altalink's senior executive management team. Mr. Dolinskiy was responsible for coordination of overall portfolio, program and project risk assessments across Altalink's major, regional and customer capital projects.

In addition, Mr. Dolinskiy served as an Audit Compliance Manager to ensure Altalink's compliance with ISO (International Organization for Standardization) and AESO (Alberta Electric System Operator) rules and regulations. Mr. Dolinskiy developed the workflow process and Audit Delivery Model, and ensured project teams' conformity to the audit requirements.

Mr. Dolinskiy developed and implemented a methodology of document management system to be utilized across Altalink's portfolio.

2007-2012
Temporary Ocean Water Desalination Demonstration Facility, West Basin Municipal Water District
Project Manager

Mr. Dolinskiy served as a Project Manager for the development, design and construction of Temporary Ocean Water Desalination Facility in Redondo Beach, CA. Mr. Dolinskiy provided project management, coordination among project team, over 20 subconsultants, and more than 10 local, state and federal regulatory agencies to provide West Basin Municipal Water District (WBMWD) with professional engineering, environmental, construction management, and operational services, necessary to complete the project.



Hashmi Quazi, PhD, PE, GE

Principal in Charge/Project Manager

Dr. Quazi works out of our Redlands office and has over 32 years of experience and 31 years with Converse Consultants providing geotechnical engineering services and has earned a reputation for providing quality work in an honest and ethical manner, on time and within budget. Dr. Quazi provides quality control, budget oversight, and technical assistance on water treatment plants, water storage, basins, pump stations and other related studies.

Relevant Experience

EVWMD Expansion & Upgrade, Lake Elsinore, CA. Principal in Charge. Provided resource and budget oversight, technical review and contract management for the geotechnical investigation. The Elsinore Valley Municipal Water District constructed a 4.0 MGD MBR Plant to expand the existing plant. Work included upgrades to the existing 8.0 MGD Extended Aeration Plant, plant-wide comprehensive condition assessment, Distributed Control System conversion to SCADA and other limited upgrades. The improvements included clarifier 6 and well point system, secondary equalization and stormwater ponds, diversion structure, stormwater drainage ditch retaining walls, stormwater return pump station, operations building expansion and maintenance workshop.

IEUA Regional Plant 1, Ontario, CA. Principal in Charge. Provided resource and budget oversight, technical review and contract management for the geotechnical investigation. The proposed improvements were located south of the existing tertiary filter banks and east of the waste wash water holding basin. The vault was located near the north of two tanks. The disinfections improvements project consisted of 4 circular steel tanks contained within hexagonal concrete structures and a valve vault. The tanks were installed on a 93 foot long by 33 foot wide concrete slab.

San Bernardino Municipal Water District Clean Water Factory, San Bernardino, CA. Principal in Charge. Provided budget and technical oversight for design phase. The project consisted of the construction of a Clean Water Factory (CWF) which will treat effluent from the San Bernardino Water Reclamation Plant (SBWRP) and convey the treated effluent to the Waterman Basins and the East Twin Creek Spreading Grounds. Recycled water spread at these facilities will artificially recharge the Bunker Hill Groundwater Basin.

HDWD Water Reclamation Facility, Yucca Valley, CA. Principal in Charge. Provided budget and technical oversight for design phase. The Hi-Desert Water District (HDWD) Wastewater Reclamation Facility was located on a 16.4 acre site northeast of Sunnyslope Drive and Indio Avenue in Yucca Valley, California. The project included ponds, basins, pump stations, aeration tank, maintenance/operations building, electrical building, above-ground and underground utilities, asphalt and concrete pavement, and open spaces. The facility has the capacity of processing 1.0 million gallons per day.

Montclair Valley Water District Plant 30 Wellhead Treatment Plant, Montclair & Ontario, CA. Principal in Charge. Provided budget and technical oversight for the proposed project. The project consisted of improvements of a Wellhead Treatment Plant within the existing Well 30 to treat water from Montclair Valley Water District (MVWD) Wells 30 and 32, and from Well 33. The project will provide treatment for 1,2,3-TCP, perchlorate, and nitrate at Wells 30, 32, and 33. Well 33 is the only one of the 3 wells with current treatment consisting of more than disinfection. MVWD intends to bring the treated Well 33 water and untreated Well 32 water to the Well 30 site for granular activated carbon (GAC) and partial ion exchange (IX) treatment.

EDUCATION

- Ph.D., Civil Engineering, University of Arizona, 1987
- M.S., Civil Engineering, Arizona State University, 1982
- B.S., Bangladesh Engineering University, 1978

REGISTRATIONS/CERTIFICATIONS

- California, Civil Engineer, #46651, issued 2/1/1991, expires 6/30/2021
- California, Geotechnical Engineer, #2517, issued 2/8/2001, expires 6/30/2021

OFFICE LOCATION

Redlands, California



Samir Hijazi, Asso. AIA

Architect

Bachelor of Science in Architecture, 1988

College of Architecture
University of Houston
Houston, TX

Land Use and Environmental Planning, 1991–1992

University of California at Irvine (UCI)
Irvine, CA

Project Management Certificate, 2008

California State University - Fullerton
Fullerton, CA

Connected:

Construction Specification Institute, CSI

American Institute of Architects, AIA

International Code Council, ICC

Measurement Science Conference, MSC

Professional Summary:

- Recognized for completing multi-million dollar projects on time and on budget for private and public clients
- Combines excellent managerial and team-building skills with effective project controls.
- A mastery of the financial aspects of construction assembly replacement costs and useful life analysis.
- Extensive Job Order Contract (JOC) experience for municipal and governmental projects.
- Successfully managed design and construction projects for private and public clients with varying budgets and construction types.
- Represented projects at public hearings and public forums for design reviews, conditional use permitting, variances, and entitlements.
- Conducted due diligence efforts for projects through governmental discretionary processing and research.
- Demonstrated strong analytical and problem solving skills.
- Effective negotiator with strong contract administration skills.
- Managed staff and coordinated interdisciplinary consulting design and engineers for varying project types and orders of magnitude.
- Comprehensive knowledge of the construction and design industries processes and phases from both angles: design and construction.

Arch. Project Manager

Anaheim Water Treatment Plant| City of Anaheim Utilities| Anaheim, CA

Samir conducted client meetings for scope development for Reservoir Outlet Structure. Worked on the conceptual design, design development and construction document phases of the project. Coordinated the interdisciplinary engineering for the project. Managed and coordinated the permitting effort from the submittal and application phase through permit issuance from building, civil, electrical, mechanical, and fire. Departments.

Arch. Project Manager

Lenain Water Treatment Plant| City Of Anaheim | Anaheim, CA

Samir conducted client meetings for scope development for the Operations Building Remodel; led the design and

space planning effort; oversaw the design development and construction document phases. Coordinated the interdisciplinary engineering for the project. Managed the permitting effort through permit issuance from building, civil, electrical, mechanical, and fire department requirements.

Arch. Submittals and Materials Reviewer WRD -GRIP | Water Replenishment District | Lakewood, CA/

Samir's primary responsibility includes the review of submittals by the contractor for architectural material submittals to ascertain conformance with plans and specifications and quality of architectural materials and systems being installed for the project. Other responsibilities include review of conditions that may have impact on codes such as exiting, fire rating and ADA..



John D. Kenny, P.E.

Trussell Oakland Office

EDUCATION

- M.S., Civil & Environmental Engineering, *University of California at Berkeley*
- B.S., Civil, Environmental, & Architectural Engineering, *University of Kansas*

REGISTRATION

Civil Engineer, State of California, No. 82975

Issued: 5/24/14 Exp: 9/3/20

SUMMARY

John Kenny is a process and water quality expert with Trussell Technologies, Inc. He is the lead process engineer for the Santa Margarita River Conjunctive Use Project, an 8-mgd groundwater treatment project including brackish water desalination, as well as the lead process engineer for the Pure Water Monterey project, a 5-mgd groundwater replenishment reuse project utilizing ozonation upstream of membrane filtration and reverse osmosis. Mr. Kenny leverages both science and experience to solve emerging water quality issues and enjoys finding elegant solutions to complex problems.

PROJECT EXPERIENCE *(Select Projects)*

Alameda County Water District

Joint ACWD, SFPUC, and USD Purified Water Feasibility Evaluation

2019 – Present

As part of the consulting services to Alameda County Water District for their Purified Water Feasibility Evaluation, Trussell Tech will conduct a reliability assessment of the Newark Desalination Facility, which includes the use of reverse osmosis to reduce the total dissolved solids concentration of brackish groundwater.

Role: *Desalter Task Lead*

Fallbrook Public Utilities District

Santa Margarita River Conjunctive Use Project Facilities Design

2014 – Present

The Fallbrook Public Utility District is integrating a new potable water supply into their portfolio through the Santa Margarita River Conjunctive Use Project, where FPUD will receive infiltrated Santa Margarita River water from Marine Corps Base Camp Pendleton. Trussell Technologies was hired to assist with designing the SMRCUP facilities, which include iron and manganese treatment, reverse osmosis, stabilization and disinfection. The effort has included developing a raw water quality characterization of the source water, defining treatment goals, and developing alternative treatment options, developing the design through the 30-% to 100%-level for use in a bid package, bid-phase support services, engineering services during construction, and working with regulators to ensure compliance. Most recently, Mr. Kenny is helping FPUD evaluating the use of Granular Activated Carbon to treat the RO bypass.

Role: *Process and Water Quality Lead*

Monterey One Water

Pure Water Monterey Project

2013 – Present

To meet water supply needs in the region, Monterey One Water consulted Trussell Tech in developing the Pure Water Monterey project, a Groundwater Replenishment Reuse Project. Trussell Tech has been provided technical guidance from the conception phase through construction. Trussell Tech conducted preliminary bench-scale tests of new source waters, pilot-tested the treatment train, evaluated regulatory compliance, assisted with obtaining permits, assisted with public outreach, designed and helps operate their Demonstration Facility, designed the facilities, provided bid-phase support, is providing engineering services during construction, developed the Engineering Report, and developed the Operations Plan, including the Membrane Filtration Integrity Verification Protocol. Trussell Technologies helps operate the Demonstration Facility membrane filtration unit, including optimization of the backwash and chemical cleaning strategies, and used the Demonstration Facility to evaluate threshold inhibitors and optimize the RO feed pH. Mr. Kenny continues to provide technical and regulatory guidance as the project considers expansion.

Role: *Process and Water Quality Lead*

City of Santa Cruz

Graham Hill Water Treatment Plant Filter Rehabilitation, As-needed Production Support, and Source Water Quality Monitoring

2014 - 2017

Trussell Tech used their filter model and Santa Cruz's historical data to develop a filter media design for the Graham Hill Water Treatment Plant Filter Rehabilitation. Trussell Tech piloted tested the selected filter media design, along with alternatives, and a control, to validate the filter design media design prior to installation. The alternatives included dual media Granular Activated Carbon with sand and various anthracite with sand designs. Trussell Tech supported the City through the rehabilitation process, and developed alternative methods for reducing trihalomethanes in their treated water and distribution system. Trussell Tech developed jar testing procedures to evaluate disinfection alternatives. In order to support the City with increasing their San Lorenzo River water use, Trussell Tech also developed a source water monitoring program, including test plan, regular calls and final recommendations with respect to turbidity and disinfection by-products.

Role: *Project Engineer*

California American Water

Monterey Peninsula Water Supply Project Watershed Sanitary Survey

Date: 2015-2018

Trussell Tech was retained to support California American Water in pursuit of a new Domestic Water Supply Permit for the operation of the proposed Monterey Peninsula Water Supply Project (MPWSP). This effort includes watershed delineation, assessment of the quality of the source water, as well as identification of potential activities that could influence its quality. Trussell Tech prepared a report that will serve as the initial Watershed Sanitary Survey (WSS) and Source Water Assessment for the MPWSP source water – ground-filtered ocean water that is designated as groundwater under the direct influence of surface water (GWUDI). This report fulfills the requirements promulgated by EPA's Surface Water Treatment Regulations and through DDW's Drinking Water Assessment and Protection Program. Mr. Kenny provided support for with slant well sampling and analysis, assessment of brine discharge, and CO₂ emissions. The final WSS report was reviewed and approved by DDW.

Role: *Project Engineer and Technical Advisor*

City of San Diego/ Kleinfelder

Title: North City Water Reclamation Plant Tertiary Filter Capacity Evaluation and Pathogen Study

Year: 2015 – Present

The City of San Diego is in the process of expanding the North City Water Reclamation Plant (NCWRP) in

order to supply feed water to a new Advanced Water Purification Facility (AWPF) which will be used to augment the region's water supply portfolio. Trussell Technologies was consulted evaluate the capacity of the filters and to determine the removal of pathogens across the NCWRP treatment process.

California's Water Recycling Criteria limit tertiary filtration rates to 5 gallons per square foot per minute (gpm/sf); however, Trussell Technologies has previously shown that equivalent water qualities can be produced at a higher filtration rate of 7.5 gpm/sf. Trussell Technologies demonstrated to the State Water Resources Control Board Division of Drinking Water that the City of San Diego North City Water Reclamation Plant's tertiary filters have equivalent effluent water quality at a filtration rate of 8.7 gpm/sf as 5 gpm/sf, resulting in approval to operate the filters at 8.7 gpm/sf. This project involved development of the test plan, an update of the Engineering Report, development of the interim operations plan, communication with DDW, support of operations and project team to conduct testing, assessment of results.

Role: *Project Engineer*

City of Calistoga

Disinfection By-Product Control for the Wastewater Treatment Plant and Drinking Water System

2018-2019

Trussell Technologies assisted the City of Calistoga with complying with a Cease and Desist order on the discharge of trihalomethanes to the Napa River; assisted the City with considering optimization disinfection by-product precursor removal at their Kimball Water Treatment Plant; evaluate the use of on-site hypochlorite generation for their Feige Canyon water storage tank; and evaluate alternatives to remove trihalomethanes and haloacetic acids from their North Bay Aqueduct Napa water supply.

Role: *Project Lead*

Ed Macias Jr.

Electrical Inspector/Instrumentation and Controls



Firm

- MNS Engineers, Inc.

Areas of Expertise

- Electrical construction inspection
- Electrical project management
- SCADA
- Instrumentation and controls specialist
- Water and wastewater treatment plant experience
- Public works experience

Years of Experience

- Total: 26
- With MNS: 4

Education

- AS, Electronics Technology, Don Bosco Technical Institute, CA
- AA, Allan Hancock College, CA

Professional Development

- Water Distribution Operators Certification Course for Operators I and II

Office Location

- Ontario, CA

Mr. Macias specializes in electrical construction inspection services for water and wastewater treatment facilities projects. Ed has provided electrical inspection services for various clients such as the Los Angeles County Sanitation Districts (LACSD). He has extensive experience with electrical construction project management and design; electrical engineering startup and modifications of instrumentation and controls; control cabinet design and fabrication; third-party electrical point to point and functional system testing; various volt-free contacts (VFCs) installation; instrumentation and related accessory application, calibration, installation, and internal operation; conduit installation (underground and exposed); and service and repair of wastewater flowmeters and instrumentation. Ed is also experienced with AutoCAD and HMI/SCADA software. His experience includes:

Owner's Agent/Owner's Engineer (OA/OE) Services for the Groundwater Reliability Improvement Program (GRIP), Water Replenishment District of Southern California (WRD), CA. *Construction Inspector.* WRD established the GRIP to find alternative sources of water to offset the imported water used for replenishment in the Montebello Forebay. As part of the GRIP, an advanced water treatment facility (AWTF) is being designed and constructed to treat 10,000 acre feet per year of tertiary recycled water. The GRIP AWTF is located in a 5.2-acre lot, adjacent to the San Gabriel River in the City of Pico Rivera. Treatment processes include automatic strainer to protect downstream membrane treatments systems from large particles; microfiltration (MF) or ultrafiltration (UF) to reduce turbidity and silt density index (SDI) of reverse osmosis (RO) feed water; cartridge filtration to protect downstream of the RO process; RO to remove salts, minerals, metal ions, organic compounds, and microorganisms; advanced oxidation with ultraviolet light (UV) treatment using hydrogen peroxide in concert with UV to reduce N-Nitroso-Dimethylamine (NDMA) concentrations and provide additional disinfection, decarbonation to release excess carbon dioxide and stabilize the product water; and pH adjustment/corrosivity stabilization.

Vista Canyon Water Factory, City of Santa Clarita, CA. *Construction Inspector.* This \$10M project constructed the Vista Canyon Water Factory—a tertiary wastewater treatment and recycling plant to treat wastewater generated from Vista Canyon Project in accordance with the requirements of California Code of

Regulation, Title 22. During rainy weather, effluent will be conveyed to downstream facilities of the Santa Clarita Valley Sanitation District (SCVSD) facilities. The Water Factory has a design capacity of 392,000 gallons per day (GPD), which generates 371,000 GPD of effluent to be recycled. The wastewater treatment process consists of influent pumping, screening, flow equalization, extended aeration activated sludge, disc filtration, and ultraviolet (UV) disinfection. The facility building's footprint is less than an acre and consists of two separate levels of subterranean construction with the finish floor elevation extending approximately 10 to 19 feet below the surrounding finish grades. The design of the building matches the character of the community while providing protection for the treatment elements. Noise is minimized by the building enclosures and careful selection of equipment. MNS provided comprehensive inspection services for the Water Factory through the construction phase.

New Turn-Out Structures at the San Gabriel River Coastal Basin Spreading Ground, Water Replenishment District of Southern California, CA. Construction Inspector.

This project constructs two new turn-out structures and associated discharge structures at the San Gabriel River Coastal Basin Spreading Grounds, which will provide needed operational flexibility for the spreading of an additional 11,000 acre-feet per year (AFY) of tertiary recycled water and 10,000 AFY of advanced treated recycled water. Additional work includes shotcrete lining of an existing approximately 6,400-linear-foot distribution channel and the installation of new 66-inch pipelines approximately 500 linear feet along with electrical and instrumentation and control systems.

EM Enterprises, Baldwin Park, CA. Owner/Operator.

For the past 18 years, Edmundo owned EM Enterprises where he specializes in electrical project management and inspection services for various clients in Los Angeles County. He maintained long-term contracts with LACSD providing electrical project management and inspection. Sample projects include:

- Electrical project management and design at LACSD Carson Joint Water Pollution Control Plant (JWPCP) 85,000 cfm odor control with high Hp Siemens VFCs 3-500 Hp and 2-1000 Hp VFCs.
- Engineering and management for the termination team at OC-88 (7-1,500 Hp pumps with Toshiba 12kV VFCs), Hyperion Primary Sedimentation Battery-A, and 180,000 cfm odor control scrubber system. Interfaced control panels to a US filters skid system with Allen Bradley Control Logix PLCs and 500 Hp Schneider-Electric Altivar VFCs.

- Complete startup of controls and systems, third-party electrical testing including wire checking, Megger testing, and functional commissioning. Honeywell HVAC commissioning (LACSD Lab/Ops Building in Palmdale).
- Panel and control cabinet design, fabrication, and installation for MAS to UL-508 standards (specification grade). PLCs included Control Logix, Flex I/O, GE Fanuc, Siemens/TI, Modicon, and Honeywell DCS systems with RTU fabrication.
- Panel QC and fabrication for MAS prior to shipping and FAT, wire checks, Megger testing, labeling, checkout for UL-508 conformity. In shop FAT for MWD for a 7-1500 Hp Pump Station (OC-88).
- Design, fabrication, and installation of alarm annunciation panels at LACSD Carson odor control.
- Verified contractor compliance to contract specifications and drawings, NEC Codes, and NFPA-70E.
- Calibration, installation, and operation of relay logic, 4-20mA circuits and instrumentation.
- Field and factory service, warranty repairs, and calibration of ISCO water and wastewater products, water quality monitors, samplers and superior electrical voltage and power monitors/meters.

Manufacturing Automation Solutions. Project Manager/Project and Field Engineer. Ed managed a long-term contract for Manufacturing Automation Solutions (MAS) for projects up to \$4.5M.

Responsibilities included:

- Panel design, integration, layout, fabrication, quality control, FAT, installation and commissioning, and in-house cabinet inspection for UL-508 requirements.
- Design of instrumentation and controls for various MAS projects.
- Ran all MAS field employees and electrical subcontractors at the LACSD Carson odor control project.
- Calibration and startup of control cabinets, SCADA MCCs, VFCs, relay logic, 4-20mA circuits, equipment, and instrumentation.
- Third-party quality assurance for electrical contractors (Clark County Wastewater Reclamation Plant rehabilitation of existing cabinets in the field and shop and Elkhorn Reservoir in Las Vegas, NV).

FLW Inc./RC Hoffman Company, Inc., Costa Mesa, CA. ISCO Service/Calibration Technician.

Responsibilities included field and factory service, warranty repairs, and calibration of flow-monitoring products, voltage and power monitors, all brands of pH meters, chart recorders, water quality monitors, and liquid samplers.

Jason Mate, CMAA, CPEI Construction Manager



Firm

- MNS Engineers, Inc.

Areas of Expertise

- Water/wastewater projects
- Roadways
- Project management

Years of Experience

- Total: 12
- With MNS: 4

Certifications

- Certified Construction Manager, CMAA (awaiting certificate)
- Certified Public Infrastructure Inspector, APWA (issued 5/5/2017; expires 5/4/2022)
- Concrete Field Testing Technician, ACI Grade 1 (issued 4/20/2017; expires 4/29/2022)
- 10-hour Construction Safety, Cal/OSHA (issued 12/31/2015; no expiration date)

Education

- BEng, Environmental Engineering, minor in Civil Engineering (Honors), Griffith University, Queensland, Australia

Professional Development

- Stormwater Pollution Prevention Plan (SWPPP) training

Office Location

- Ontario, CA

Mr. Mate has over 12 years of experience in environmental and civil engineering. Jason's roles have ranged from project engineer, resident engineer, to project manager for several large-scale \$500M+ projects involving water/wastewater resources, transportation, and solar energy. His experience includes:

Owner's Agent/Owner's Engineer (OA/OE) Services for the Groundwater Reliability Improvement Program (GRIP), Water Replenishment District of Southern California (WRD), CA. Construction Manager. WRD established the GRIP to find alternative sources of water to offset the imported water used for replenishment in the Montebello Forebay. As part of the GRIP, an advanced water treatment facility (AWTF) was designed and constructed to treat 10,000 acre feet per year of tertiary recycled water. The GRIP AWTF is located in a 5.2-acre lot, adjacent to the San Gabriel River in the City of Pico Rivera. Treatment processes included automatic strainer to protect downstream membrane treatments systems from large particles; microfiltration (MF) or ultrafiltration (UF) to reduce turbidity and silt density index (SDI) of reverse osmosis (RO) feed water; cartridge filtration to protect downstream of the RO process; RO to remove salts, minerals, metal ions, organic compounds, and microorganisms; advanced oxidation with ultraviolet light (UV) treatment using hydrogen peroxide in concert with UV to reduce N-Nitroso-Dimethylamine (NDMA) concentrations and provide additional disinfection, decarbonation to release excess carbon dioxide and stabilize the product water; and pH adjustment/corrosivity stabilization. The 11,700-square-foot treatment facility is LEED certified with approximately 40,000 square feet of additional surface landscape and bioretention, 4,000 square feet of vegetated roof garden, with 79,000 square feet of surface parking and pedestrian hardscape.

EI Estero Wastewater Treatment Plant Tertiary Filter Replacement, City of Santa Barbara, CA. Assistant Resident Engineer. This \$8.4M project replaced the treatment plant's existing filtration system with a microfiltration (MF)/ultrafiltration (UF) facility. Work included demolition of an existing gravity filter, installation of driven concrete piles, construction of a new MF/UF facility, new filter feed pumps, replacement of chemical feed pumps, modifications to the chlorine contact basin, modifications to the reclaimed water storage reservoir, new reclaimed water transfer pumps, yard piping modifications, associated electrical and instrumentation modifications, and other appurtenant work.

New Turn-Out Structures at the San Gabriel River Coastal Basin Spreading Ground, Water Replenishment District of Southern California, CA.

Construction Manager. This project constructed two new turn-out structures and associated discharge structures at the San Gabriel River Coastal Basin Spreading Grounds, which will provide needed operational flexibility for the spreading of an additional 11,000 acre-feet per year (AFY) of tertiary recycled water and 10,000 AFY of advanced treated recycled water. Additional work included shotcrete lining of an existing approximately 6,400-linear-foot distribution channel and the installation of new 66-inch pipelines approximately 500 linear feet along with electrical and instrumentation and control systems.

Government Wastewater Treatment Plant (WWTP) Upgrade (ICI), Ontario, Canada.

Project Superintendent/Engineer. This \$15M project constructed a new state-of-the-art polymer distribution system for sludge discharge, a new oil handling facility, civil cut/fill operation for new roads and access paths, retrofit of entire WWTP facility including a four-story demolition and reinstallation of concrete slabs and office layout. Project management responsibilities included conformance to stringent government specifications, requests for information (RFIs), monthly draws, cost estimating, close-out reports, document control, weekly contract negotiations and bid approval, quality assurance/quality control (QA/QC) inspections, project scheduling and update (250-line CPM schedule), four-week-look-ahead schedule, operations and maintenance (O&M) manuals, as-built markups, cost and budget management, and weekly client meetings. Project completed successfully on time and within budget; 10% extra work was granted with full use of contingency. The project resulted in a \$500K/year savings for client and plant capacity increased from 17M to 22M liters per day.

Utility Scale Solar Farm (30 megawatts) for FIT program with LEED Certification, Ontario, Canada.

Assistant Project Manager/Project Engineer. This \$135M project required CAD layout and pre-side inspection of three utility scale solar farms with road access, module layout, structural footings, cultural excursion zones, racking supports, inverter, structural pads, substation, and interconnection point. Responsibilities included managing the principal contractor (PCL Constructors and RES USA), contract compliance, scheduling milestone and phase construction, problem solving design discrepancies onsite, extra work approvals, and quality assurance/quality control (QA/QC) inspections with 200 manpower onsite daily. Project management tasks included weekly and monthly reporting; monthly draws and cost; requests for information (RFIs); NCR; letters

and notices; engineer reporting; chairman meetings; operations and maintenance (O&M) manuals; four-look-ahead forecast schedule; submittal of future project plans, testing plans, permits; contract negotiation; native exclusion zoning; and complete site due diligence for three future solar farm locations.

Two Main Roads Government Projects, Brisbane, Canada.

Site Engineer. This \$700M major roadway infrastructure improvements project involved multiple subprojects: construction of large cut/fill operations, landscaping, and embankments (\$7M); installation of 110,000 tons of four-lane highway asphalt (\$10M); inner city installation of stormwater drainage and manholes (\$1.5M); construction of a new road including diversions and traffic switches, which required 10 to 15 closures per week \$1.25M; and installation of heavy-duty structural walls for a new road subgrade and paving (\$5M). Detailed and site specific paperwork were created for each project including safe work method statements, process control plans, specification conformance, scheduling, bid analysis, contractor meetings, engineer meetings, permitting (road closure), NCR, requests for information (RFIs), and budgeting. Responsibilities included managing a total of \$20-25M as a client engineering representative of AECOM and SKM, contract management, and site engineering.



John Robinson
Principal
John Robinson Consulting, Inc.

Education/Training

BS, Civil Engineering, California State University, Long Beach, 1993

Licenses/Registrations

Engineer in Training – CA

Office Location

Pasadena – CA

Key Experience

- ✓ Facilitator and Technical Advisor for multiple Infrastructure Projects
- ✓ Assisted clients with 50 environmental documents (CEQA, NEPA, EIS and EIR) documents.
- ✓ Provided technical and management support for preliminary design through construction for projects.

Summary

Mr. Robinson's over 25 years of environmental engineering experience has focused exclusively on water reclamation, wastewater engineering, and wastewater master plan projects for municipalities in California and Arizona. He has been the Principal-in-Charge or Project Manager for infrastructure projects that include feasibility/master studies and planning, preliminary and final design, bidding, construction management and commissioning. His project experience includes 15 new water reclamation and wastewater facilities, 4 groundwater treatment projects, 300 miles of sewer, potable water and recycled water pipeline designs, 15 pump stations, 12 groundwater wells and 10 reservoirs and 45 master plans for water, sewer and recycled water.

Mr. Robinson has served as both a principal in charge as well as program manager for approximately fifty (50) environmental documentation projects. As a principal in charge, he has on numerous occasions successfully led my project teams to complete the work within the project budgets and time schedules and with a high degree of responsiveness to the clients. His project experience includes California Environmental Quality Act (CEQA), Environmental Impact Reports (EIRs), Initial Studies (IS) and NEPA for developments, water resource and federal projects.

Relevant Project Experience – Agency Coordinator

Principal-in-Charge, Rosemead Extension, City of Rosemead, CA - Mr. Robinson managed the preliminary and final design and construction services for 6000-LF of 18-inch CML&C Steel and Ductile Iron Pipe alternate recycled water pipeline within the City of Rosemead. The project serves approximately 510 AFY to three adjacent irrigation customers.

Centralized Groundwater Treatment System, City of Monterey Park – Owner's representative for the permitting of the Centralized Groundwater Treatment System (CGTS) project that involves the permitting and approval from SWRCB DDW and USEPA for the treatment of groundwater pumped from the South El Monte Operable Unit. Permitting agency efforts includes the development of a 97-005 report as well as a Title 22 report both for DDW review and approval. Mr. Robinson is coordinating with the City for the Department of Water Resources Proposition 84, Round 3 funding of approximately \$4.0M as well as assisting staff in the daily inspection of the facility that is being constructed as a part of a design/build.

Project Manager, Whittier Narrows Water Recycling Project Phase IIA-Pipeline and Pump Station Expansion, Upper San Gabriel Valley Municipal Water District, CA - The facilities for the project include a pump station and reservoir at the County Sanitation Districts of Los Angeles County Whittier Narrows Water Reclamation Plant and approximately 18,000 linear feet of pipeline.

Project Manager, Hollydale Pump Station and Pipeline, Central Basin Municipal Water District and City of Vernon, South Gate, CA - Mr. Robinson's responsibilities included the preliminary design, design, and construction management of the Hollydale Pump Station located in the City of South Gate and approximately 8,000 linear feet of 12-and 18-inch

recycled water pipeline to supply Marburg Generation Station. Part of the planning of the system included the ENVISION rating system. The facilities were in partnership between Central Basin Municipal Water District and City of Vernon.

Principal In Charge, 2015 Urban Water Management Plan, Foothill Municipal Water District, La Canada Flintridge, CA - Mr. Robinson's responsibilities included three (3) workshops involving staff members from FMWD, their 8 member agencies, City of Pasadena, City of Glendale and Metropolitan Water District. The first two meetings were to discuss short term emergency storage and supply issues and the 2nd workshop as to discuss long term emergency storage and supply issues. The 3rd workshop included the general manager of the agencies and reviewed the conclusions from the previous workshops and further developed next steps to secure the service area during short and long term emergencies.

QA/QC, Highland Pump Station, Yorba Linda Water District, CA - Mr. Robinson provided a QA/QC review for the new pump station that will include a combination of natural gas pumps and electric pumps to provide redundancy for this critical facility. Part of the planning of the system included the ENVISION rating system. The pump station will be in a new building with a separate electrical room. Backup power to the electric motors will be provided from the existing natural gas generator that was constructed in 2004. The pump station will be located adjacent to the existing Highland Reservoir and very close to an existing residence.

Relevant Project Experience – Environmental Assistance

Program EIR and Permitting, Recycled Water Distribution System, Central Basin Municipal Water District, Commerce, CA – Mr. Robinson prepared environmental compliance and permitting for the construction of 25 miles of recycled water distribution pipelines in existing city streets for the cities of East Los Angeles, Commerce, Montebello, Pico Rivera, West Whittier- Los Nietos and Whittier. Part of the planning of the system included the ENVISION rating system. The analysis complied with the EIR environmental requirements of the State Water Resources Control Board since the project sought State Revolving Fund (SRF) loans and grants.

Program EIR and Permitting, Recycled Water Distribution System, San Gabriel Valley Municipal Water District, Azusa, CA – Mr. Robinson prepared environmental compliance and permitting for the construction of 15 miles of recycled water distribution pipelines in existing city streets for the cities of Alhambra and Montebello. Part of the planning of the system included the ENVISION rating system. The analysis complied with the EIR environmental requirements of the State Water Resources Control Board since the project sought State Revolving Fund (SRF) loans and grants.

CEQA Compliance and Permitting, Recycled Water Distribution System Phase IIB, Upper San Gabriel Valley Municipal Water District, West Covina, CA – Mr. Robinson prepared environmental compliance and permitting for the construction of 12 miles of recycled water distribution pipelines in existing city streets and three aboveground steel tank reservoirs to be sited in the existing residential neighborhoods of the cities of West Covina and Walnut. Part of the planning of the system included the ENVISION rating system. The analysis complied with the CEQA-Plus environmental requirements of the State Water Resources Control Board since the project sought State Revolving Fund (SRF) loans and grants.

Environmental and Permit Tasks Leader, Mid-Valley Pipeline CEQA and Permitting, CVWD, Coachella, CA – Mr. Robinson completed CEQA compliance (Subsequent EIR) and obtained permits for the pumping station and 7-mile-long pipeline project to serve Coachella Canal water to up to 50 golf courses. Permits included USACE Clean Water Act (CWA) section 404 Nationwide Permit, Regional Board CWA section 401 Water Quality Certification, California Department of Fish and Game Streambed Alteration Agreement, and a modification of CVWD Water Reclamation Plant No. 10 operation permit. Mr. Robinson oversaw a wetland jurisdiction delineation and delineations of waters of the State and waters of the US for the channel and negotiated onsite and offsite mitigation measures.

Project Scientist, Federal Environmental Impact Analyses, US Army Corps of Engineers, Bureau of Reclamation, Fort Irwin, CA – Mr. Robinson has prepared environmental impact analyses under NEPA for the USACE, the US Navy, the Engineering Staff at Fort Irwin, California, and the US Bureau of Reclamation (Boulder City, Yuma, and Sacramento offices). He has also prepared environmental documents under NEPA regulations of the United States Agency for International Development (USAID). Mr. Robinson prepared an Environmental Assessment (EA) for USACE on wastewater conveyance and disposal facilities in Prado Basin, a wetland habitat containing several endangered bird species, and developed construction mitigation measures with the US Fish and Wildlife Service.



R. Rhodes Trussell, Ph.D., P.E., BCEE

Trussell Pasadena Office

EDUCATION

- Ph.D., Sanitary Engineering, *University of California, Berkeley*
- M.S., Sanitary Engineering, *University of California, Berkeley*
- B.S., Civil Engineering, *University of California, Berkeley*
- Graduate, *Stanford Executive Program*

REGISTRATION

Civil Engineer, State of California – No. 25107
 Issued: 2/12/75 Exp: 12/31/21
 Corrosion Engineer, State of California – No. 745
 Issued: 3/9/77 Exp: 9/30/21

CERTIFICATION

Board Certified Environmental Engineer,
 American Academy of Environmental Engineers
 – No. 89-30012 Issued: 1/1/90 Exp: 12/31/20

HONORS

1995 National Academy of Engineering
 2001 AAMWA Boyd Award
 2005 AEESP/AEE Pohland Medal
 2010 AWWA Black Award
 2012 IWA's Global Water Award
 2013 NWRI Clarke Prize

ORGANIZATIONS:

- American Association of Environmental Engineering Professors (Associate)
- American Chemical Society
- American Society of Civil Engineers
- American Institute of Chemical Engineers

- American Water Works Association (Life Member)
- California Water Pollution Control Association
- International Water Association
- National Association of Corrosion Engineers
- Sigma Xi - The Scientific Research Society of North America
- Water Environment Federation

SUMMARY

Dr. Trussell is recognized worldwide as an authority in the field of water treatment. His career has been characterized by the use of fundamental scientific principles and research to effectively design water treatment plants and improve treatment technologies. He is often called upon to help utilities effectively manage critical projects involving regulatory authorities and public health. Dr. Trussell has also for more than 40 years maintained an active practice in the corrosion of materials in water systems, having conducted more than a dozen pipe-loop tests. Dr. Trussell was awarded the 2013 Clarke Prize from the National Water Research Institute, for his extraordinary accomplishments. Dr. Trussell has authored more than 200 publications. He has worked on the process designs for dozens of treatment plants, ranging from 1 to more than 900 mgd in capacity, and has experience with numerous physiochemical and biological processes. Dr. Trussell is available to review and advise on any complex water quality problem.

PROJECT EXPERIENCE (*Select Projects*)

Stanislaus Regional Water Authority/ West Yost Associates

Title: Regional Surface Water Supply Project

Year: 2016 - Present

Driven by historic drought conditions, degradation of groundwater supplies, and declining groundwater levels, the Stanislaus Regional Water Authority is seeking to develop a reliable supplemental surface water supply. Trussell Tech led the evaluation of the proposed source water, reviewed historical water quality data, and developed a sampling plan to address any data gaps. The sampling plan defined parameters to be analyzed, analytical methods, and sampling

frequency. Trussell Tech worked with DDW to gain approval of the proposed source water monitoring, and reviewed the collected data and prepared a technical report summarizing the results. In addition, Trussell Tech evaluated treatment alternatives for the new source water. This included the development of treatment goals, evaluation of source water impacts, and recommendation of treatment processes. Trussell Tech executed a bench-scale testing plan to evaluate the impacts of enhanced coagulation using jar tests and ozonation using solution ozone testing. The test plan included an evaluation of DBP formation, as well as process performance of coagulation, sedimentation, and ozonation. Trussell Tech performed all necessary data analysis and prepared a report summarizing the results. Currently, Trussell Tech is providing technical guidance on treatment process selection and RFP documents for the selection of a Design-Build firm to construct the new 15 MGD surface water treatment plant, with projected expansion to 45 MGD.

Role: *Technical Advisor*

Hazen and Sawyer/New York Department of Environmental Protection (NYDEP)

Title: Catskill/Delaware Water Supply Blue Ribbon Expert Panel

Date: 2018 – Present

Dr. Rhodes Trussell is on the second year of a seven year assignment to serve on the Blue Ribbon Expert Panel appointed to advise Hazen and Sawyer and the New York Department of Environmental Protection (NYDEP) in completing bench testing, pilot testing, process selection, and conceptual design for a future filtration plant for the Catskill/Delaware water supplies. The Catskill/Delaware sources have met the criteria for waiving the United States Environmental Protection Agency requirements per the Surface Water Treatment Rule (SWTR) since EPA's SWTR came into effect in 1993, but the waiver requires that the NYDEP complete a preliminary design and cost estimate so that filtration can be quickly implemented should the supply fail to meet the requirements of the waiver in the future.

Davis-Woodland JPA/ West Yost Associates

Title: Davis-Woodland Water Supply Project

Year: 2009 – 2016

The Cities of Davis (Davis) and Woodland (Woodland) and the University of California at Davis (UC Davis) are working in partnership to develop a regional water supply for this “new” water supply integration project. The Davis-Woodland Water Supply Project (DWWSP) is intended to divert and treat Sacramento River water and convey the resulting potable water to the project partners. Trussell Technologies, Inc. was hired by West Yost to assist with treatment process selection, procurement document preparation and permitting for the Davis-Woodland Water Supply Project (DWWSP). As part of this project, Trussell Technologies has conducted a detailed analysis of historical and current water quality of the Sacramento River; prepared a report of the occurrence and treatment of synthetic organic chemicals, including pharmaceuticals and personal care products (PPCPs) and endocrine disrupting chemicals (EDCs), in the Sacramento River; conducted bench-scale tests assessing enhanced coagulation, disinfection by-product formation and ozone demand of this water; prepared permitting documents for submittal to CDPH, participated in process train selection and conceptual-level facility design for a new 40 mgd treatment facility; and assisted in preparation of procurement documents for selection of a Design-Build-Operate team to construct and operate this new 40 mgd surface water treatment facility.

Role: *Technical Director*

City of Woodland

Title: Surface Water Project

Year: 2016

Trussell Tech worked with the City of Woodland to address issues related to colored water in its distribution system after integration of a new surface water supply into its historically groundwater distribution system. Trussell Tech assembled a panel of corrosion experts to review water quality and distribution system data to understand the cause of the colored water and plan for implementation of additional monitoring, and recommended solutions.

Role: *Technical Advisor/ Expert Panel Leader*

California American Water

Title: Owner's Representative for Monterey Peninsula Water Supply Project

Year: 2014 – Present

California American Water (CAW) is pursuing the Monterey Peninsula Water Supply Project (MPWSP) to develop a new water supply to replace the region's existing reliance on the Carmel River and Seaside Aquifer. This project includes a new desalination facility to produce drinking water from seawater pulled from the Pacific Ocean via beach wells, the potential for expansion of CAW's current Aquifer Storage and Recovery activities, and related facilities (pipelines and desalination brine disposal). Trussell Tech, with expertise in desalination, post treatment, corrosion control, and DDW permitting, is serving as the owner's representative for the MPSWP with regards to these topics. Trussell Tech is assisting CAW with development of the seawater desalination facility conceptual design, consisting of pretreatment, reverse osmosis, post-treatment, and disinfection; technical guidance during the Design Build procurement process, including RFP document preparation; and application to Proposition 50 grant funding. Trussell Tech is also working with CAW to ensure a smooth permitting process with DDW on this new water supply and treatment plant, by facilitating meetings and providing technical and scientific guidance on the necessary monitoring and treatment processes to meet current and future regulations. In addition, because bringing a new water supply into an existing distribution system has the potential to create corrosion issues and consumer complaints, Trussell Tech is working with CAW to pre-emptively understand the situation and develop strategies to minimize future distribution system issues.

Role: *Technical Advisor*

EBMUD/ MWH

Mokelumne Aqueduct Corrosion Optimization Study

Year: 2014 – 2016

Trussell Tech performed an evaluation of corrosion control strategies for the East Bay Municipal Utilities District (EBMUD). The cement mortar lining (CML) in two of EBMUD's aqueducts

had shown signs of deterioration and EBMUD hired the Trussell Tech/MWH team to evaluate different aqueduct lining alternatives and various water quality strategies to manage corrosion. Dr. Trussell served as a Technical Advisor to the team, who began by reviewing the historical and existing corrosion control strategies and the condition of the existing linings. The team developed a framework for defining the potential aqueduct lining materials and water quality options. The team worked with EBMUD to refine the water quality goals and establish design criteria for improvements to the stabilization treatment technologies, including the addition of lime, CO₂, and caustic to maximize treatment efficiency and protect pipes in the distribution system.

Role: *Technical Advisor*

MWH/San Francisco Public Utilities Commission

Title: Comprehensive Report on Lead and Copper Rule Compliance

Date: 2005 - 2006

Working with MWH, Trussell Tech was retained to prepare a comprehensive report on the implementation of the lead and copper rule in the San Francisco Water System, and in the Regional Water Systems also served by SFPUC. The study addressed past and current practice, compared it to the practices of several other U.S. cities treating similar water supplies and recommended pH adjustment as corrosion control treatment. The study also included an extensive assessment of the impact of this strategy on the protection of cement-based assets in the system and made recommendations to maximize their protection. Finally, the study examined the rationale for water quality parameters in the system to address lead and copper rule requirements. In the end all the recommendations of the study were approved by CDHS.

Role: *Project Manager*



Mr. Vickers is President of SPI and a nationally recognized authority in membrane treatment processes used for recycled water and drinking water treatment. His expertise covers over 36 years with MF/UF/NF/RO membrane technology including membrane procurement, piloting, design, commissioning and operational support. Mr. Vickers is a primary reviewer of the AWWA MF and UF Manual of Practice (MOP) and author of the chapters on membrane system design and cost. He is also one of the primary authors of the USEPA Membrane Filtration Guidance Manual. Mr. Vickers is the former chair of the AWWA Membrane Process Committee.

Education:

B.S., Chemical Engineering -
Youngstown State University
1982

MS Engineering Management –
George Washington University
1991

Registrations/Certifications:

Registered Professional
Engineer in California CH 5979,
issued 6/1/2000, expires
9/30/2020

Professional Affiliations:

AWWA, AMTA

Employment History:

Separation Processes, Inc.
2000 - Present

Malcolm Pirnie, Inc. 1993 – 2000
Memtec America Corporation
1988 – 1993

Filterite (Brunswick-Memtec
America Corp) 1984 - 1988

Area of Expertise:

Microfiltration
Ultrafiltration
Nanofiltration
Reverse Osmosis
Drinking Water Treatment
Coagulation & Process
PLC/SCADA

Years of Experience:

36

Years with SPI:

20

Office Location:

Carlsbad, CA

Mr. Vickers has a detailed understanding of membrane integrity and regulatory compliance issues. He has recently developed a concept for automated conductivity profiling for characterizing RO membrane LRVs. This concept has won awards from the USBR crowd sourcing prize as part of its Pathogen Challenge program. He has also obtained a provisional patent to allow for further development. He recently received the 'best paper award' for his conductivity profiling paper presented at the AMTA/AWWA Membrane Technology conference in 2019.

EXPERIENCE

YUCAIPA VALLEY WATER DISTRICT

Yucaipa Valley Regional Water Filtration Facility, Yucaipa, CA (2002–Present)

Project Manager – Jim is the Project Manager for the membrane system design of a 12 mgd MF and 6 mgd NF membrane treatment facility. SPI has assisted the District with various phases of the project including, MF procurement, MF and NF pilot testing, NF membrane procurement, membrane system engineering design, construction services, O&M Manual preparation and provided commissioning and start-up services. The facility was recognized as the 2010 AMTA Plant of the Year.

YUCAIPA VALLEY WATER DISTRICT

NF SCRAM Project, Yucaipa, CA (2009-Present)

Project Manager – Jim is the Project Manager for the membrane system design of a 3 mgd NF membrane treatment system expansion to the facility. SPI developed the basis of design, contract drawings and specification for a 95 percent recovery NF system that will increase the overall NF system recovery to 98 percent.

SAN PATRICIO MUNICIPAL WATER DISTRICT

20 mgd Facility Expansion Study, Ingleside, TX (2012–Present)

Project Manager – Jim is the Project Manager for the development of a facility plan to increase facility capacity by 20 mgd. The facility planning study assessed the conditions of the existing facilities, evaluated hydraulic limitations, and determined which structures would be retained, abandoned or modified. The study also included the development of a 12 mgd expansion alternative using a non-proprietary (universal) membrane system design. The output of the project will be used to develop a sequence of improvements necessary to expand the facilities.

SAN PATRICIO MUNICIPAL WATER DISTRICT

2013 TPCO Expansion Project, Ingleside, TX (2012–Present)

Project Manager – The project is for the expansion of the 16.55 mgd Plant C Facility to 19.4 mgd using Pall microfiltration. Jim is the Project Manager and membrane process design engineer for this facility which commenced operation in 2000. The Project includes new sedimentation basins, chemical feed equipment and storage facilities as well as additional Pall Membrane Filtration Equipment.

**SAN PATRICIO MUNICIPAL WATER DISTRICT****Ingleside Facility Planning Study (2012-2014)**

Project Manager – Jim was the project manager to identify the site constraints of the District facilities located in Ingleside Texas. Expansion requirements and phasing alternatives were developed to increase the capacity of the Plant C facility from 19.4 mgd to 32 mgd using a Universal Membrane Filtration System for the expansion. SPI developed facility and equipment requirements and developed a layout for a Universal Membrane System

MONTEREY REGIONAL WATER POLLUTION CONTROL AUTHORITY**Advanced Water Treatment Facility (2016 – present)**

Technical Specialist – Developed plans and specifications for the procurement of a 6 mgd Universal Membrane Filtration system designed to accommodate membranes from 4 different suppliers (Pall, Toray, Dow, Scinor). Prepared the technical specification, developed programming and control requirements and selected equipment to satisfy the individual requirements

WEST BASIN MUNICIPAL WATER DISTRICT**Universal Membrane Filtration System, Los Angeles, CA (2013-Present)**

Project Manager – As Project Manager and design engineer for a universal “non-proprietary” microfiltration/ultrafiltration system that can test up to 3 membrane modules using the same or different operating conditions, Jim developed P&ID’s, and equipment layout and requirements, as well as specification for the major component equipment.

WEST BASIN MUNICIPAL WATER DISTRICT**Portable Membrane Filtration System, Los Angeles, CA (2013-Present)**

Quality Control Engineer – Jim was the engineer for a 1.0 mgd “non-proprietary” microfiltration/ultrafiltration system that will be used by the District to augment its existing membrane treatment capacity at various sites. He reviewed the project specifications and proposal offerings of various equipment suppliers for conformance to the project requirements.

YUCAIPA VALLEY WATER DISTRICT**Wochholz WISE Project, Yucaipa, CA (2010-2013)**

Project Manager – Jim was the Project Manager for the design of a new 2.5mgd RO system in order to reduce salinity in Title 22 reclaimed water in order to achieve groundwater basin objective. SPI was the prime consultant for the various phases of the project including, Conceptual Design, Detailed Design, and Construction Management and start up.

GROUNDWATER REPLENISHMENT SYSTEM, ORANGE COUNTY, CA (2013-2016)

Construction Manager (Subcontractor) – Jim is assisting with the construction and start-up of the 30 mgd expansion (100 mgd total) Microfiltration and Reverse Osmosis system to treat secondary effluent for injection into the seawater intrusion barrier and for aquifer recharge. His responsibilities included oversight of the start up for microfiltration reverse osmosis and chemical feed systems.

ORANGE COUNTY WATER DISTRICT**Groundwater Replenishment System, Orange County, CA (2016-present)**

Project Advisor/Extension of District Staff– Jim is currently assisting the District as a Project Advisor/Extension of the District Staff for the design of the 30mgd Final Expansion (130mgd total). His responsibilities include preparation of procurement documents, review of Technical Memorandums and other deliverables developed by the design engineer.

GROUNDWATER REPLENISHMENT SYSTEM, ORANGE COUNTY, CA (2013-PRESENT)

SARI Feasibility Study Water Quality Specialist (Subcontractor) – Jim is assisting with analysis of alternatives necessary to expand the GWRS system from 100 mgd to 130 mgd. Microfiltration and Reverse Osmosis and Advanced oxidation will be used to system to treat secondary effluent for injection into the seawater intrusion barrier and for aquifer recharge. His responsibilities included analysis and commentary regarding the water quality available from OCS&D’s Plant 1 and Plant 2 to determine the impact on MF and RO processes as a function of water quality.

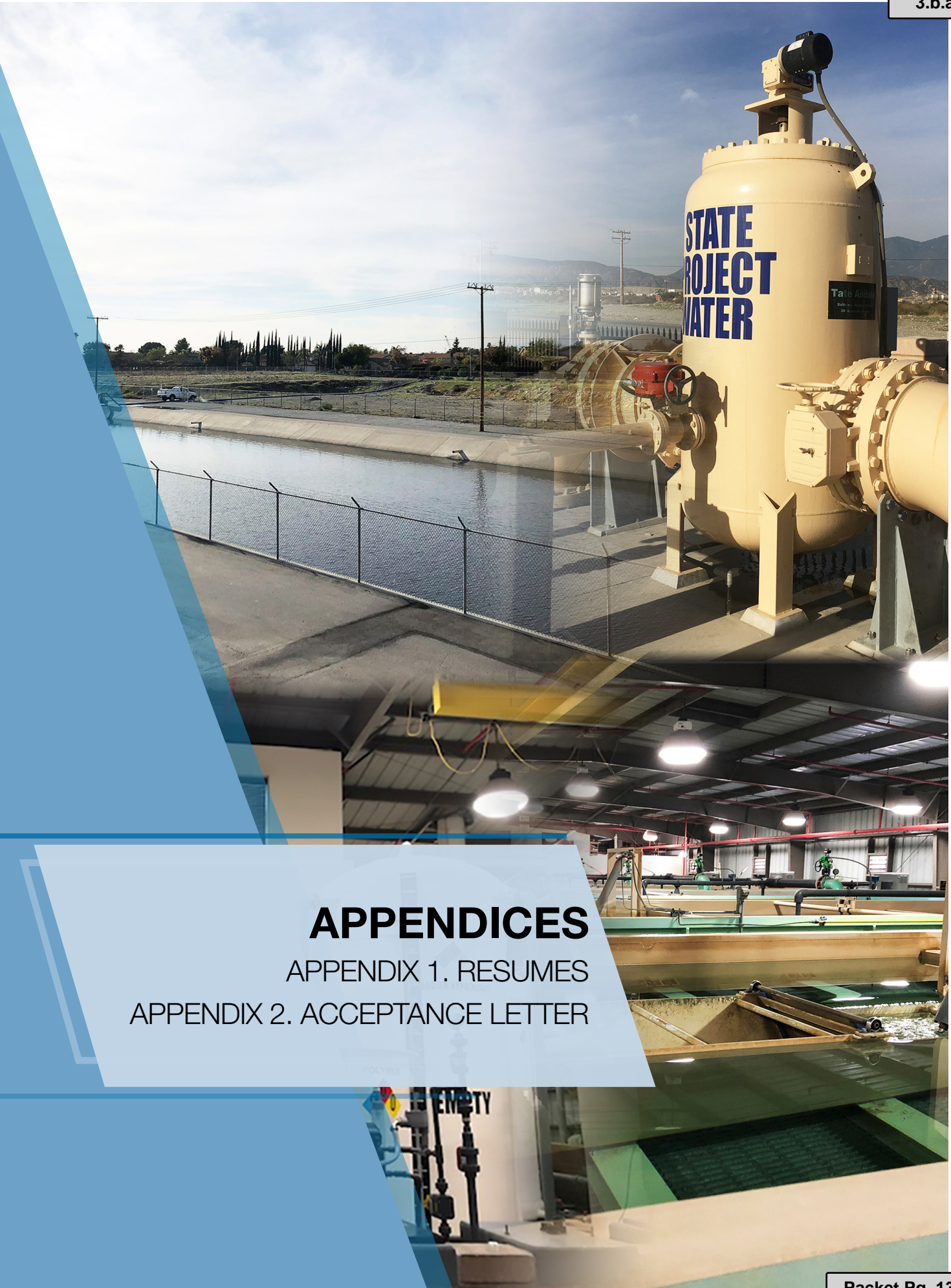

APPENDICES
APPENDIX 1. RESUMES
APPENDIX 2. ACCEPTANCE LETTER

ACCEPTANCE LETTER

Company Name: GHD Inc.

Address: 175 Technology Drive, Suite 200, Irvine, CA 92618

Telephone: P 949 585 5200

Subject: Solicitation for Professional Engineering Design Services for the
16 MGD Oliver P. Roemer Water Filtration Facility
Expansion Project

By my signature below, I, on behalf of the Company named above, acknowledge that I have read and understand the subject solicitation and all its attachments. I further acknowledge that, by submission of a submittal, proposal, quotation, or bid in response to the subject solicitation, the Company named above accepts all the terms and conditions, and meets the minimum requirements set forth in the subject solicitation and its attachments, including, but not limited to, the Sample Agreement for Professional Services Standard Terms and Conditions.

ACCEPTED:



Signature

Paul Hermann, CPEng

Name (please print)

Principal / Vice President

Title

1.15.2020

Date



about GHD

GHD is one of the world's leading professional services companies operating in the global markets of water, energy and resources, environment, property and buildings, and transportation. We provide engineering, environmental, and construction services to private and public sector clients.

Jamal Awad, PhD, PE
Jamal.Awad@ghd.com
949.585.5235

www.ghd.com



**BOARD OF DIRECTORS
ENGINEERING AND PLANNING COMMITTEE
STAFF REPORT**

DATE: March 11, 2020
TO: Engineering and Planning Committee
FROM: Clarence Mansell Jr., General Manager
SUBJECT: CONSIDER A JOINT USE AGREEMENT WITH CALTRANS FOR TRANSMISSION PIPELINES CROSSING THE 210 FREEWAY AT CACTUS AVENUE IN THE CITY OF RIALTO

BACKGROUND:

In May of 2001, West Valley Water District (“District”) and the California Department of Transportation (“Caltrans”) entered into a Utility Agreement to relocate the District’s existing transmission pipelines under the proposed 210-Freeway at Cactus Avenue in the City of Rialto. As the District has prior rights, the relocation of the pipelines was funded by Caltrans’s project.

In October 2016 the District was contacted by a Caltrans Right of Way Utility Coordinator who was trying to identify and verify the District’s waterline location at the southwest quadrant of the 210-Freeway at Cactus Avenue in the City of Rialto. Discussions ensued and it came to light that although there was a Utility Agreement in place, a Joint Use Agreement (“JUA”) for construction, reconstruction or future maintenance needed to be generated.

DISCUSSION:

Staff has been working with Caltrans since October 2016 to obtain a JUA and easements for a 24-inch and 18-inch transmission pipeline in Cactus Avenue where they cross under the 210-Freeway. Attached, as Exhibit A, is a final draft of the JUA between the District and Caltrans. Legal counsel is currently reviewing the JUA.

FISCAL IMPACT:

No fiscal impact.

STAFF RECOMMENDATION:

It is recommended that the Engineering, Operations and Planning Committee approve the Joint Use Agreement with Caltrans, and have this item considered by the full Board of Directors at a future meeting.

Respectfully Submitted,



Clarence Mansell Jr, General Manager

LJ:ce

ATTACHMENT(S):

1. Exhibit A - Joint Use Agreement

EXHIBIT A

California Department of Transportation
District 8 Office of Right of Way
464 W. Fourth Street, MS 950
San Bernardino, CA 92401-1400
Attention: Jerry Americh R/W Utility Coordinator

3.c.a

STATE BUSINESS: FREE

This is to certify that this document is presented for record by the State of California under Government Code Section 27383 and is necessary to complete the chain of title of the State to property acquired by the State of California.

By Jerry Americh

STATE OF CALIFORNIA - DEPARTMENT OF TRANSPORTATION

Space above this line for Recorder's Use

JOINT USE AGREEMENT

RW-13-1 (REV 12/2018)

DISTRICT	COUNTY	ROUTE	POST MILE	JUA NO.
08	San Bernardino	210	128+95 to 129+40	24936-1

THIS AGREEMENT, entered into this _____ day of _____, 20____, by and between
West Valley Water District,

hereinafter called "Owner," and the STATE OF CALIFORNIA, acting by and through its Department of Transportation, hereinafter called "State."

WITNESSETH

WHEREAS, Owner is in possession of certain rights of way and easements, hereinafter referred to as "Owner's easement," and described as prior and superior right: perpendicular crossing of Route 210 just west of Cactus Avenue in the City of Rialto and

WHEREAS, State has acquired certain lands for highway purposes in the vicinity of Cactus Avenue at Route 210 in the City of Rialto,

County of San Bernardino on State Road RT 210, hereinafter referred to as "highway right of way,"

which said highway right of way is subject to Owner's easement; and

WHEREAS, Owner's facilities on said highway right of way will interfere with or obstruct the construction, reconstruction, maintenance or use of said highway, and State desires to eliminate such interference or obstruction.

NOW, THEREFORE, Owner and State hereby mutually agree as follows:

1. The location of Owner's easement so far as it now lies within said highway right of way be and it hereby is changed to the strip of land within said highway right of way hereinafter referred to as "new location," described as follows:
Described as Exhibit "A" and Depicted as Exhibit "B1" and Exhibit "B2" all of which are attached to, and made part of, this Joint Use Agreement
2. Owner will rearrange, relocate or reconstruct within said new location any of its facilities now installed pursuant to Owner's easement within said highway right of way and Owner does hereby surrender and quitclaim to the State all of Owner's right, title and interest under and by virtue of Owner's easement in the old location within said highway right of way and not included in said new location. Owner hereby consents to the construction, reconstruction, maintenance or use by State of a highway over, along and upon Owner's easement both in the old location and in the new location within said highway right of way upon and subject to the terms and conditions herein contained.
3. State acknowledges Owner's title to Owner's easement in said new location and priority of Owner's title over the title of State therein. Owner has and reserves the right and easement to use, in common with the public's use of said highway, said new location for all of the purposes for which Owner's easement was acquired, without need for any further permit or permission from State. Except in emergencies, Owner shall give reasonable notice to State before performing any work on Owner's facilities in said new location where such work will be performed in, on or over the traveled way or improved shoulders of said highway or will obstruct traffic. In all cases, Owner shall make adequate provision for the protection of the traveling public.

JOINT USE AGREEMENT

RW-13-1 (REV 12/2018)

JUA NO.
24936-1

- 4. Owner shall exercise its rights of way solely by use of the gates installed in the freeway fence (right or left) of Engineer's Stations 207 feet left of STA 129+08 and 156 feet right of STA 129+05. The said gates (and road approach) shall not be used for any purpose other than construction, reconstruction, operation, inspection, repair or maintenance of Owner's facilities now or hereafter installed pursuant to Owner's easement. Owner shall close and lock said gates after each use thereof by Owner.
- 5. In the event that the future use of said highway right of way shall at any time or times necessitate a rearrangement, relocation, reconstruction or removal of any of Owner's facilities then existing in said new location the State shall notify Owner in writing of such necessity and agree to fund Owner in advance for such relocation, on demand. Owner will provide documentation for its costs incurred, after such relocation, in complying with such notice. Owner will provide State with plans of its proposed rearrangement and an estimate of the cost thereof and, upon approval of such plans by State, Owner will promptly proceed to effect such rearrangement, relocation, reconstruction or removal. Owner shall make adequate provisions for the protection of the traveling public. No further permit or permission from State for such rearrangement shall be required and State will (1) enter into a Joint Use Agreement on the same terms and conditions as are herein set forth covering any such subsequent relocation of Owner's facilities within said highway right of way, (2) provide executed document(s) granting to Owner good and sufficient easement outside of the highway right of way if necessary to replace Owner's easement or any part thereof, and (3) fund Owner for any costs which it may be required to expend to acquire such easement, provided it is mutually agreed in writing that Owner shall acquire such easement.
- 6. Except as expressly set forth herein, this Agreement shall not in any way alter, modify or terminate any provision of Owner's easement. Both State and Owner shall use said new location in such a manner as not to interfere unreasonably with the rights of the other. Nothing herein contained shall be construed as a release or waiver of any claim for compensation or damages which Owner or State may now have or may hereafter acquire resulting from the construction of additional facilities or the alteration of existing facilities by either State or Owner in such a manner as to cause an unreasonable interference with the use of said new location by the other party.
- 7. This Agreement shall inure to the benefit of and be binding upon the successors and assigns of both parties.

IN WITNESS WHEREOF, the parties hereto have caused this Agreement to be executed in duplicate by their respective officials thereunto duly authorized.

RECOMMENDED FOR APPROVAL:

Name: Vincent Lundblad
Title: CA District 8 Senior Utility Coordinator

OWNER

By

Name: Clarence C Mansell Jr.
Title: General Manager
West Valley Water District



If Required:

Name: Jerry Arnerich
Title: CA District 8 Right of Way Utility Coordinator

By

Name:
Title:

**STATE OF CALIFORNIA
DEPARTMENT OF TRANSPORTATION**

Director of Transportation

By

Rebecca Guirado, Deputy District 8 Director, Right of way
Attorney in Fact

Exhibit "A"
Legal Description
Joint Use Agreement Parcel No. 24936-1

The west 40.00 feet of the east 90.00 feet of the southeast quarter of the southeast quarter of Fractional Section 27 and the west 40.00 feet of the east 90.00 feet of the northeast quarter of Section 34, Township 1 North, Range 5 West, San Bernardino Meridian, according to the Official Plat thereof, situated in the City of Rialto, County of San Bernardino, State of California.

EXCEPTING THEREFROM all that portion of said Section 27 lying northerly of the northerly right-of-way line of State Route 210 as shown on map filed in Book 160, Pages 26 through 44, of Records of Survey, in the Office of the County Recorder of said County.

ALSO EXCEPTING THEREFROM all that portion of said Section 34 lying southerly of the southerly right-of-way line of State Route 210 as shown on said Record of Survey map.

The bearings and distances used in the above description are on the California Coordinate System of 1983 (Epoch 1984.00), Zone V. Divide the above distances by 0.999909961 to obtain ground level distances.

This real property description has been prepared by me, or under my direction, in conformance with the Professional Land Surveyors' Act.

Signature *Jonathan D. Maddox*
Jonathan D. Maddox, PLS

Date: February 05, 2020



08-SBd-210-PM R17.9-24936 (24936-1)

**CITY OF RIALTO
COUNTY OF SAN BERNARDINO
T.1N., R.5W., S.B.M.**

DIST.	COUNTY	ROUTE	POST MILE
08	Sbd.	210	R17.9

EXHIBIT "B1"
SHEET 1 OF 2

BOHNERT AVENUE

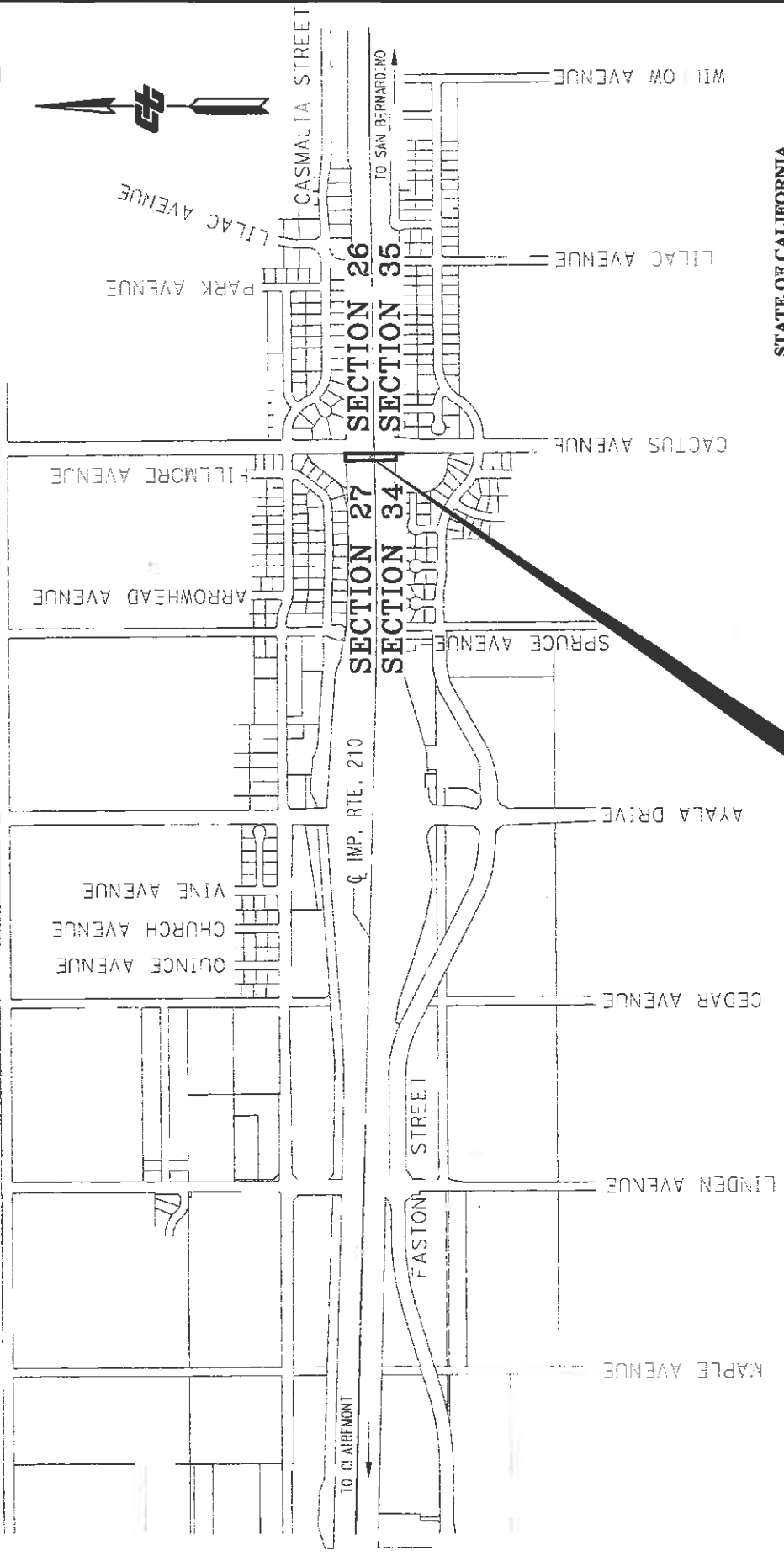

STATE OF CALIFORNIA
 CALIFORNIA STATE TRANSPORTATION AGENCY
 DEPARTMENT OF TRANSPORTATION
RIGHT OF WAY
JOINT USE AGREEMENT MAP
 J U A No. 24936-1
 VICINITY MAP
 NO SCALE

J.U.A. PARCEL No. 24936-1
 JOINT USE AGREEMENT
 (WEST VALLEY WATER DISTRICT)

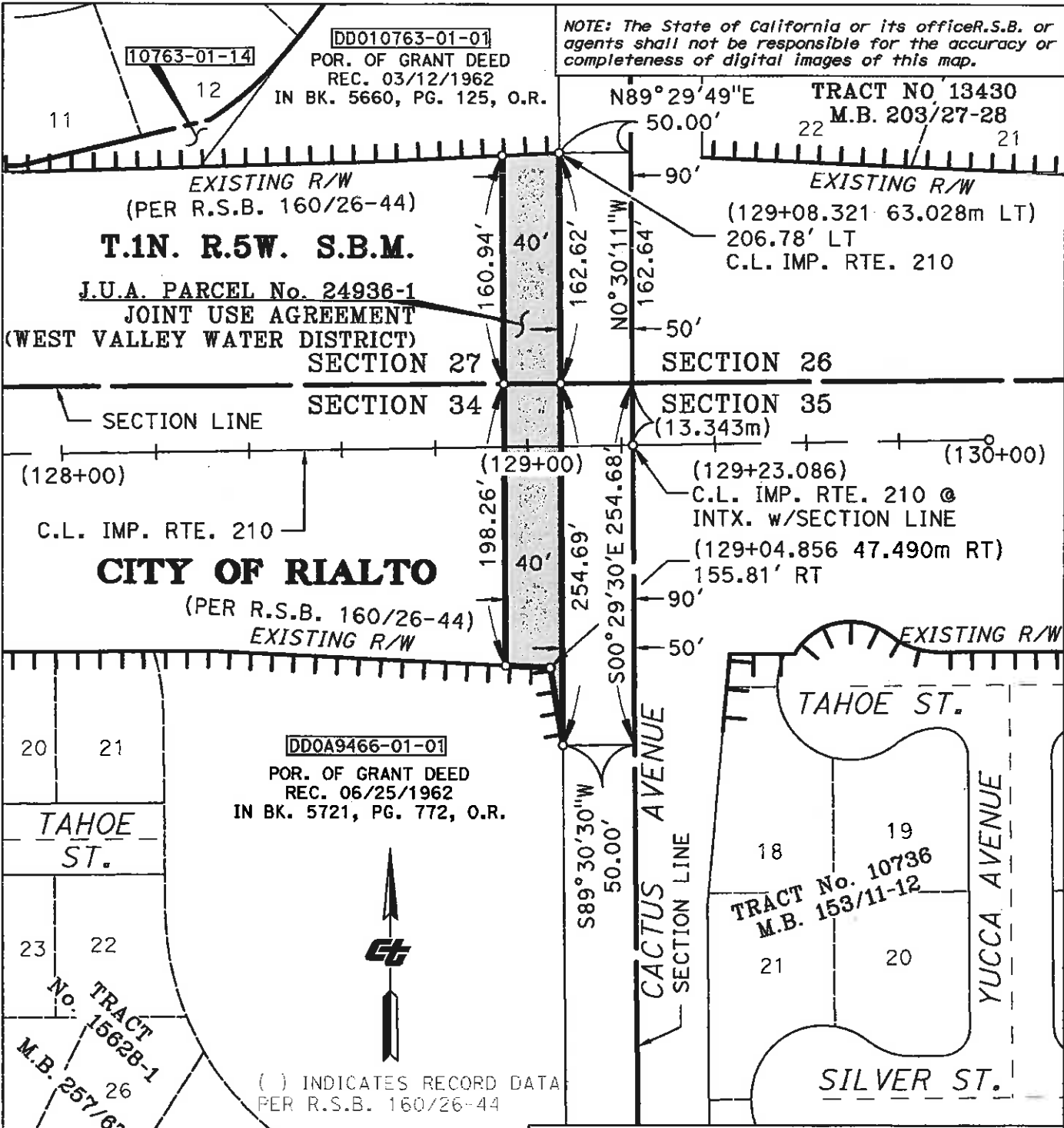

NOTES
 Bearings and distances are on CCS 1983, Zone V. Distances and stationing are grid distances. Divide by 0.999909961 to obtain ground distances. All distances are in feet unless otherwise noted.

EXHIBIT "B2"
 SHEET 2 OF 2

STATE OF CALIFORNIA
 CALIFORNIA STATE TRANSPORTATION AGENCY
 DEPARTMENT OF TRANSPORTATION
RIGHT OF WAY
JOINT USE AGREEMENT MAP
 J U A No. 24936-1
DETAIL MAP
 COPYRIGHT 2019 CALIFORNIA DEPARTMENT OF TRANSPORTATION.
 ALL RIGHTS RESERVED.
 NO SCALE

DRAFTED BY	DATE	DISTRICT	COUNTY	ROUTE	SHEET PM	SHEET NO.	TOTAL SHEETS
Jonathan Maddox, LS 9257	02/05/2020	08	Sbd	210	R17.9	2	2

ACKNOWLEDGMENT

A notary public or other officer completing this certificate verifies only the identity of the individual who signed the document to which this certificate is attached, and not the truthfulness, accuracy, or validity of that document.

State of California
County of _____)

On _____ before me, _____
(insert name and title of the officer)

personally appeared _____,
who proved to me on the basis of satisfactory evidence to be the person(s) whose name(s) is/are subscribed to the within instrument and acknowledged to me that he/she/they executed the same in his/her/their authorized capacity(ies), and that by his/her/their signature(s) on the instrument the person(s), or the entity upon behalf of which the person(s) acted, executed the instrument.

I certify under PENALTY OF PERJURY under the laws of the State of California that the foregoing paragraph is true and correct.

WITNESS my hand and official seal.

Signature _____ (Seal)



**BOARD OF DIRECTORS
ENGINEERING AND PLANNING COMMITTEE
STAFF REPORT**

DATE: March 11, 2020
TO: Engineering and Planning Committee
FROM: Clarence Mansell Jr., General Manager
SUBJECT: CONSIDER A REIMBURSEMENT AGREEMENT WITH THE LYTLE DEVELOPMENT COMPANY FOR CONSTRUCTION OF A 30-INCH TRANSMISSION PIPELINE

BACKGROUND:

In the early 2000's, West Valley Water District ("District") embarked on a multi-year project to transport up to 20 million gallons per day of Bunker Hill Groundwater to the District's northern service area. The multi-year project began with the preparation of CEQA documents to construct transmission pipelines across the Lytle Creek Wash from the District's East End Complex to Terrace Avenue. The District then obtained approval from the railway to allow boring under their facilities. Finally, in 2007 over 4,400 linear feet of transmission pipeline was constructed. Subsequent sections were constructed in 2010, 2011, 2013, 2017 and 2019. Section 5 involved the lengthy coordination process with Caltrans to construct the pipeline under the 210-Freeway and Section 6 was plagued with difficult excavation due to several feet of concrete tile roofing material encountered underground. Section 6 of the 30-inch transmission pipeline was completed in 2019 and ended at the intersection of Oakdale Avenue and Highland Avenue in the City of Rialto.

The alignment of future Section 7 was anticipated to travel up Riverside Avenue to the District's Reservoir 4-3 site where 14 million gallons of storage will eventually be located. Riverside Avenue is a busy street that contains numerous existing utilities. There is limited space to construct a 30-inch transmission pipeline. Not only would this alignment be very difficult to construct within, but the cost to repave the street would add a significant cost to the project. Other alignments for the 30-inch transmission pipeline were evaluated, each with their own challenges.

One of the alignments evaluated was through the future Lytle Creek Ranch master-planned community. This alignment had several pros and only one con. The pros to this alignment were that the transmission pipeline could be designed and constructed in a brand new roadway at the same time that the development was constructing utilities to serve their housing development. This would eliminate any unforeseen underground obstacles during construction. This alignment would also eliminate the cost to replace pavement. The disadvantage to this alignment was the timing of the two projects. Attached as Exhibit A, is the current and proposed alignment of the 30-inch transmission pipeline through the development.

DISCUSSION:

Lytle Development Company (“Developer”) is the owner of land located north-east of Riverside Ave. in the City of Rialto, formerly known as the El Rancho Verde Golf Course. This area is part of the Lytle Creek Ranch master-planned community. The Developer plans to construct their most southerly housing tract and the main transportation corridor this summer. This new roadway will contain the developments utilities such as storm drain, sewer, water, gas and dry utilities. The main entrance to the Lytle Creek Ranch master-planned community will be from Oakdale Avenue off Highland Avenue.

As these two projects are progressing at the same time, and at the same location, the District is requesting that the Developer construct 7,700 linear feet of 30-inch transmission pipeline when the Developer is installing other utilities. This would save the District the costly expense of replacing pavement, avoid the numerous conflicts that would be encountered in an existing roadway installation and reduce any potential change orders. As outlined in the Reimbursement Agreement, attached as Exhibit B, the District will reimburse the Developer for the actual cost of constructing the 30-inch transmission pipeline.

The Developer will obtain a minimum of three (3) bids from the District’s pre-approved list of contractors. The lowest responsible bid will be reviewed and approved by the District prior to construction. All materials used will be approved by the District and the District will oversee the inspection of the facilities installed.

FISCAL IMPACT:

The estimated cost to construct the 30-inch transmission pipeline is \$2,000,000 but the actual cost of the reimbursement will be based on the bid received from the successful bidder. The reimbursement costs would also include third-party out of pocket costs incurred such as design costs, insurance and bonding. These costs would be paid upon acceptance of the facilities by the District. This item is not included in the fiscal year 2019/2020 budget. The costs associated with the reimbursement agreement will be included in the fiscal year 2020/2021 budget.

STAFF RECOMMENDATION:

It is recommended that the Engineering, Operations and Planning Committee approve the Reimbursement Agreement with the Lytle Development Company for the construction of the 30-inch transmission pipeline, and have this item considered by the full Board of Directors at a future meeting.

Respectfully Submitted,



Clarence Mansell Jr, General Manager

LJ:ce

ATTACHMENT(S):

1. Exhibit A - Pipeline Alignment
2. Exhibit B - Reimbursement Agreement

EXHIBIT A



Exhibit A Transmission Pipeline

- reservoirs**
 - Proposed (Green circle)
 - Existing (Blue circle)
- Pump Station**
 - Proposed (Purple square)
 - Existing (Orange square)
- Pipeline**
 - Existing (Green line)
 - In Design (Blue dashed line)

EXHIBIT B

REIMBURSEMENT AGREEMENT

THIS REIMBURSEMENT AGREEMENT (“Agreement”) is made and entered into this ____ day of _____, 2018, by and between the WEST VALLEY WATER DISTRICT, a public agency of the State of California (“District”), and THRIFTY OIL, INC, a California Corporation (“Applicant”). District and Applicant are sometimes referred to herein singularly as “Party” and collectively as the “Parties.”

RECITALS

WHEREAS, the Applicant is the owner of certain real property located at the northwest corner of Cedar Avenue and Orange Street in the unincorporated area of Bloomington, County of San Bernardino, State of California, legally described as Parcel 1 on Parcel Map 15729 in Exhibit “A” attached hereto and by this reference incorporated herein (“Cedar and Orange Business Center”).

WHEREAS, Applicant is developing a commercial project (“Project”) on APN 0253-171-16.

WHEREAS, the Project will require multiple water connections in order to provide water service to Cedar and Orange Business Center, including, without limitation, those water facilities described and/or depicted on Exhibit “B” attached hereto and by this reference incorporated herein (“Facilities”).

WHEREAS, the District desires that a portion of the Facilities be oversized or constructed (“Reimbursable Facilities”). The description of the Reimbursable Facilities to be oversized or constructed are described on Exhibit “C” attached hereto and by this reference incorporated herein.

WHEREAS, by approval of the Board of Directors of the District, District authorized certain reimbursement to Applicant arising out of the oversizing and construction of the Reimbursable Facilities by or on behalf of Applicant.

WHEREAS, Applicant desires the District to provide domestic water service to Cedar and Orange Business Center, and the District is willing to accept such transfer and to provide domestic water service to Cedar and Orange Business Center on the terms and conditions set forth herein.

NOW, THEREFORE, THE PARTIES HEREBY AGREE AS FOLLOWS:

1. Applicant shall at Applicant’s sole cost and expense, be responsible for compliance with the California Environmental Quality Act (“CEQA”) and all other applicable state and federal environmental laws and all requirements of the Federal Endangered Species Act and the California Endangered Species Act arising out of or in connection with the design and construction of the Facilities and for compliance with all conditions and mitigation measures which must be satisfied in connection with the same. As part of its obligation to fund the CEQA process, Applicant shall prepare or

cause to be prepared all instruments, documents, reports and other like or kind writings required to be prepared and/or filed by CEQA. District has received a copy of the Mitigated Negative Declaration for the Project approved by the County on May 04, 2017 as referenced in Exhibit “D” attached hereto.

2. District has approved West Valley Water District Waterline Improvement Plans, Offsite Water Plan Cedar and Orange Business Center – D18005 (“Plans”). Notwithstanding the approval, District shall have no responsibility for the Plans and Applicant hereby releases the District from and waives on its behalf and on behalf of its successors and assigns, all Costs (as that term is defined herein) for any matter arising out of or in connection with the Plans, including review thereof. Applicant represents and warrants to District, to Applicant’s knowledge that the Plans conform to all applicable federal, state and local laws, rules, ordinances and regulations. To Applicant’s knowledge, after due inquiry, the Plans are complete, accurate, workable and are in compliance with all governmental requirements with respect thereto.

3. The Facilities shall be constructed in the locations identified in Exhibit “B” attached hereto and by this reference incorporated herein (“Route”). Applicant shall not change the Route without the prior written consent of District, which consent may be withheld in District’s sole and absolute discretion. Prior to construction and acceptance of the Facilities, Applicant shall furnish to District easement documents or encroachment permits for public rights-of-way satisfactory to District (in its sole and absolute discretion) as to content, form and width which assures District’s unequivocal right to own, operate, maintain, replace, repair, enlarge, reconstruct, remove and improve the Facilities. Applicant shall ensure that all deeds of trust, mortgages and monetary liens and encumbrances are subordinated to the easements referred to herein.

4. The provisions of Resolution No. 397 designated as the Rules, Rates and Regulations for Water Service by the West Valley Water District and any amendments thereto, are hereby incorporated by reference in this Agreement. Notwithstanding the foregoing, Applicant shall construct the Facilities in accordance with the following requirements:

- a. Prior to commencing work on any Facility, Applicant shall arrange a pre-construction meeting. At such meeting there shall be at least one (1) representative of Applicant, Applicant’s contractor and District.
- b. *The Applicant* shall utilize one of the Districts pre-approved contractors and submit a copy of the contract between the Applicant and the selected contractor, to the District for review and approval.
- c. *The Applicant and* the selected contractor shall agree to install waterlines only after the construction of concrete curb and gutter.
- d. The Applicant shall deposit, in advance, all required funds and inspection fees.

- e. The Applicant shall provide material list submittal to District for approval.
- f. Prior to commencing work on any Facility, Applicant shall, at its sole cost, expense, and liability, obtain all necessary permits and licenses and give all necessary and incidental notices required for the lawful construction of the Facilities and performance of Applicant's obligations under this Agreement.
- g. The Facilities shall be completed in strict accordance with the Plans and specifications, and all other applicable maps, plans, specifications, standard drawings and special amendments thereto approved and on file with District. Any deviations from the approved Plans must be approved by District, in writing, prior to being made. The Facilities shall be completed in conformance with all applicable federal, state, and local laws, ordinances, regulations codes, standards, and other requirements.
- h. Applicant and its contractors shall construct the Facilities in a skillful and workmanlike manner, and consistent with the standards generally recognized as being employed by professionals in the same discipline in the State of California. Applicant represents and maintains that its employees and its contractors shall be skilled in the professional calling necessary to perform the work. Applicant warrants that all of its employees and contractors shall have sufficient skill and experience to perform the work assigned to them, and that they shall have all licenses, permits, qualifications and approvals of whatever nature that are legally required to perform the work, and that such license, permits, qualifications and approvals shall be maintained throughout the term of this Agreement.
- i. Once construction and/or installation of the Facilities has commenced, Applicant shall diligently prosecute the same to completion at no cost or expense to District, except for the reimbursement set forth in Section 6.
- j. District shall be under no obligation to protect the Facilities or any material, tool and equipment until written acceptance thereof by District. Prior to the acceptance of the Facilities, Applicant shall bear all risk of loss or damage thereto by whatever cause inflicted. Applicant shall rebuild, repair, restore and replace or cause to be rebuilt, repaired, restored or replaced, and make good all injuries or damages to any portion of the Facilities before completion and acceptance by District and Applicant shall bear the expense thereof.
- k. Applicant shall directly pay all costs associated with the construction and installation of the Facilities, including, but not limited to, furnishing of materials, and Applicant shall keep District free and harmless from such costs, except for the reimbursement set forth in Section 6.

1. Applicant may not be subject to all of the same requirements as would be applicable to District had District undertaken construction of the Facilities, including, without limitation, the payment of prevailing wages, and other public works requirements pursuant to the California Labor Code, the California Government Code and the California Public Contracts Code. Applicant undertakes such construction at Applicant's risk. Should Applicant not pay prevailing wages or if it be determined in the future by either the legislature or a court of competent jurisdiction that Applicant was required to comply with some or all of the requirements as would be applicable to District had it undertaken such construction of the Facilities, Applicant shall indemnify, defend and hold harmless the District Indemnitees (as defined below) from all Costs (as defined below) to which they may be subjected or put, by reason of or resulting from failure to comply with public works requirements, including, but not limited to, the failure to pay prevailing wages or such other requirements as would be applicable to District had it undertaken such construction.

- m. Applicant hereby irrevocably appoints District to inspect the construction and installation of the Facilities. Applicant shall provide District representatives with reasonable access for inspection purposes. It is understood and agreed that District's inspection personnel shall have the authority to enforce the Plans, which authority shall include requiring that all unacceptable materials, workmanship and/or installation be replaced, repaired or corrected by Applicant's contractor. Nothing herein shall be construed to grant District direct control over Applicant's contractor. District's inspection does not include inspection for compliance with safety requirements by Applicant's contractor. Any inspection completed by District shall be for the sole use and benefit of District, and neither Applicant nor any third party shall be entitled to rely thereon for any purpose. Except for District's duties and obligations set forth in this Agreement, District does not undertake or assume any responsibility for or owe a duty to select, review or supervise the creation of the Facilities.

In the event of an inconsistency or ambiguity between the terms of this Section and Resolution No. 397, the terms of Resolution 397 shall control.

5.
 - a.
 - (i) Upon completion of the Facilities, Applicant shall give District notice of the same. District shall make a final inspection and provide written notice to Applicant either (A) confirming that the Facilities have been completed in accordance with the requirements of this Agreement or (B) setting forth a punch list of items that need to be completed or corrected. If District provides such a punch list, the above-referenced notice and inspection procedure shall be repeated upon completion of the punch list items. Nothing herein shall be considered a waiver of any warranty, guarantee or other right in favor of the District.

- (ii) Upon completion and acceptance of the Facilities, Applicant shall prepare and District shall execute a Certificate of Completion as to the Facilities in such form and content as set forth in California Civil Code Section 8182 and record said notice with the Office of Recorder of the County of San Bernardino, State of California. In addition, thereto, District shall record a document releasing the lien of this Agreement with respect to Cedar and Orange Business Center. The release of the lien of this Agreement shall not affect any term of condition set forth herein.
 - (iii) Upon receipt of the Certificate of Completion, the Applicant shall provide a bill of sale to District in the form of Exhibit "E" attached hereto or such other form as shall be reasonably acceptable to the District which shall convey title to the Facilities to District at no cost and expense to the District except for the reimbursement set forth in Section 6. The Facilities shall be transferred to District free of all liens and encumbrances. Upon acceptance of the bill of sale, District shall own and operate the Facilities subject to any express warranties set forth herein. Subject to the Applicant satisfying the requirements and the District's rules and regulations, including, but not limited to, the payment of fees, District shall provide domestic water service to Cedar and Orange Business Center, subject to circumstances within the control of District or as otherwise provided by the District's rules, regulations, policies and procedures, as may be amended from time to time. Further, Applicant acknowledges that domestic water service shall be provided from such facilities as shall be available to the District. In the event water is unavailable to serve all of District's customers, service to Cedar and Orange Business Center may be discontinued or subject to reduction in service, as determined by the District.
- b. Upon completion of the Facilities, Applicant shall cause all contractors, subcontractors and materialmen to provide unconditional lien and material releases and provide copies of the same to District prior to District's acceptance of the Facilities.
 - c. Applicant shall provide District with a declaration by all contractors that the contractors and all persons and entities who furnished material in the construction of the Facilities have been paid in full.
 - d. All permits, plans and operating manuals related thereto, shall be delivered to and become the sole property of the District, subject to Applicant's warranty work and other obligations required hereunder. On the acceptance of the Facilities, Applicant shall deliver to District, at no cost

to the District, all surveys and as-built drawings associated with the construction of the Facilities.

6. a. The Applicant estimates that the cost to construct the Reimbursable Facilities is as follows:
 - (i) SEVENTEEN THOUSAND SEVEN HUNDRED SEVENTY NINE DOLLARS (\$17,779.00) representing the oversizing of the waterline in Cedar Place from the eight inch (8") cross located at the north end of the cul-de-sac to Cedar Avenue. From eight inches (8") to twelve inches (12"); and
 - (ii) TWENTY THREE THOUSAND SIX HUNDRED NINETY DOLLARS (\$23,690.00) representing the installation of twelve inch waterline in Cedar Avenue. From the intersection of Cedar Place and Cedar Avenue to the point of connection at the ten inch (10") water line in Orange Street.

Notwithstanding the foregoing, the amount of the reimbursement to be paid to Applicant by District shall be the amount determined herein. Applicant shall obtain a minimum of three (3) bids from the District's approved list of contractors. Applicant shall prepare alternate bid items for the Project showing the cost to construct the Facilities with and without the Reimbursable Facilities. Applicant shall furnish to the District true and accurate copies of bids received. Applicant shall award the contract to the lowest bidder for the Project which includes the Reimbursable Facilities. In addition to the foregoing, Applicant shall be required to post payment and performance bonds as required by the District for the Facilities. District shall have the right to review and approve the bids and the successful bidder. The District shall reimburse the Applicant between the bid by the successful bidder for the Facilities without the Reimbursable Facilities and with the Reimbursable Facilities.

- b. Applicant will not issue a change order with respect to the Reimbursable Facilities without the prior written consent of District, which consent shall not be unreasonably withheld. Subject to the foregoing, District shall have no obligation to pay any cost increases for changes to the work for the Reimbursable Facilities unless District has approved the same in writing.
- c. Upon the completion of the Facilities and the acceptance thereof pursuant to Section 5 of this Agreement, and upon the compliance by Applicant with Section 5.b and 5.c, Applicant shall submit an invoice to District for the Reimbursable Facilities. The invoice shall include an itemized accounting. The invoice shall be subject to the review and approval by District, which approval shall not be unreasonably withheld. District shall pay the undisputed portion of the invoice within thirty (30) days of receipt

thereof. Payment of the disputed amount, if any, shall be paid within ten (10) business days following resolution of the payment dispute, with interest at the rate of ten percent (10%) per annum beginning on the date that District paid the undisputed amount and ending on the date that District pays the agreed-to disputed amount

7. Applicant shall be required to repair any Facility which has been damaged by any party (other than by District or its Representatives) prior to District's acceptance of the Facility. Applicant shall provide to District a two (2) year guarantee bond (following the date of final acceptance of the Facility) acceptable in form and substance to District (in its reasonable discretion), for defects in materials and workmanship which appear within said two (2) year period (the "Warranty Period"). In addition, thereto, Applicant specifically agrees to make or require Applicant's contractor to repair, at its or their expense, all failures of the Facilities (or any portion thereof) which was furnished, installed and/or constructed due to faulty materials or installation, within the Warranty Period. In the event surety, Applicant or Applicant's contractor fail to cause satisfactory repair, as reasonably determined by District, within forty-eight (48) hours after written notice or such longer period of time as District may reasonably determine (the "Repair Period"), District may cause such repairs to be completed at Applicant's cost and expense. Notwithstanding the Repair Period, District shall have the unqualified right to immediately make any emergency repairs reasonably necessary to eliminate any imminent and material threat to the public's health, safety or welfare, at Applicant's cost and expense. Nothing in this Section shall limit or abrogate any other claims, demands or actions District may have against Applicant or Applicant's contractor on account of damages sustained by reason of such defects, nor shall the provisions of this Section limit, abrogate or affect any warranties in favor of District which are expressed or implied by law or set forth in any construction agreement.

8. The Applicant shall assume the defense of, indemnify and hold harmless District and its officers, directors, administrators, representatives, consultants, engineers, employees and agents, and their respective successors and assigns (collectively, "District Indemnitees") and each and every one of them, from and against all actions, causes of action, damages, demands, liabilities, costs (including, but not limited to reasonable attorneys' fees), claims, losses and expenses of every type and description (collectively, "Costs") to which they may be subjected or put, by reason of, or resulting from: (A) the design, engineering and/or construction of the Facilities; (B) the performance of or failure to perform, the work covered by this Agreement which is caused or occasioned by any act or neglect on the part of Applicant or its Representatives (as defined below); (C) any death, injury, property damage, accident or casualty caused or claimed to be caused by the negligence or willful misconduct of Applicant or its Representatives or including Applicant or its Representatives or its or their property; and (D) any breach by Applicant of its obligations under this Agreement. The foregoing indemnity shall not apply to the extent any such Costs are ultimately established by a court of competent jurisdiction to have been caused by any act or omission on the part of District Indemnitees or any of them. Nothing herein shall be construed to increase the Warranty Period set forth in Section 7. District shall make all decisions with respect to its representation in any legal proceeding concerning this Section. If Applicant fails to do so, District shall have the

right, but not the obligation, to defend the same and charge all of the reasonable direct or incidental costs of such defense, including reasonable fees and costs, to Applicant and to recover the same from Applicant. The term “Representatives” shall mean employees, representatives, agents, contractors, subcontractors or any other persons directly or indirectly employed by any of the foregoing or reasonably under the control of any of the foregoing or for whose acts any of the foregoing may be liable. Except as expressly provided herein, no provision of this Agreement shall in any way limit the extent of the responsibility of Applicant for payment of damages resulting from its operations or the operations of any of its Representatives.

- 9. a. Unless otherwise approved by District in writing, Applicant shall carry and maintain, at Applicant’s sole cost and expense, until all of the Facilities have been installed or completed, not less than the following coverage and limits of insurance which shall be maintained with insurers and under forms of policies satisfactory to District:
 - (i) Worker’s Compensation and Employer’s Liability:
 - (A) State Workers Compensation – coverage as required by law.
 - (B) Employer’s Liability with limits of at least \$1,000,000 per occurrence.
 - (ii) Automobile Liability for Bodily Injury, Death and Property Damage - \$2,000,000 per person, \$2,000,000 per occurrence.
 - (iii) Commercial General Liability for Bodily Injury, Death and Property Damage - \$2,000,000 per person, \$2,000,000 per occurrence.
 - (iv) Builder’s Risk Insurance covering no less than the total construction costs of all Facilities to be constructed by Applicant hereunder. Coverage shall be on an “all risks basis.” The coverage shall include vandalism coverage which remains in force until acceptance of all the Facilities by the District, automatic inclusion of underground exposure, coverage to be on a replacement basis, and waiver of co-insurance penalties.

The foregoing policies shall include, without limitation, owned, non-owned and hired automobile (vehicle) liability, contractual liability, personal injury, blanket commercial, broad form property damage and product/completed operation liability coverage. These policies may contain an aggregate limit not less than the occurrence limit. The required limits may be satisfied by a combination of a primary policy and an excess or umbrella policy.

- b. (i) All insurance required pursuant to the express provisions of this Agreement shall:

- (A) Provide that coverage shall not be revised, cancelled or reduced until at least thirty (30) days written notice of such cancellation shall have been given to District. In the event any policies of insurance are revised, cancelled or reduced, Applicant shall, prior to the revision, cancellation or reduction date, submit evidence of new insurance to the District complying with this Section.
 - (B) Be issued by insurance companies which are qualified to do business in the State of California and which have a rating satisfactory to District and by such rating service as shall be reasonably acceptable to District.
 - (C) Be reasonably satisfactory to District in all other reasonable respects.
- (ii) The policies required pursuant to this Agreement or a certificate of the policies, together with evidence of payment of premiums, shall be provided to District prior to the commencement of construction of the Facilities. Any Certificate of Insurance and additional insured endorsement(s), if any, attached hereto as Exhibit "F" are approved by District as satisfying all requirements of this Section 9 unless otherwise stated in Exhibit "F."
- (iii) The general liability insurance to be maintained by Applicant pursuant to this Section shall:
- (A) Name District, its officers, and employees as additional insureds;
 - (B) Apply severally to Applicant and District, its officers and employees.
 - (C) Cover Applicant and District as insureds in the same manner as if separate policies had been issued to each of them;
 - (D) Contain no provisions affecting the rights which either of them would have as claimants if not so named as insured.
 - (E) Be primary insurance with any other valid and collectible insurance available to the aforesaid additional insureds constituting excess insurance and each policy shall be endorsed substantially as follows:

“The insurance afforded by this policy to District shall be primary insurance and other valid and collectible insurance available to District shall be excess insurance and, under no circumstances, shall be considered contributory.”

- (F) Have a deductible or deductibles, if any, which are no greater than those normally maintained from similar projects in the State of California and shall contain a waiver of subrogation and endorsement in favor of the District.

10. All notices, demands, invoices, and written communication shall be in writing and delivered to the following addresses or such other addresses as the Parties may designate by written notice:

To District: West Valley Water District
 Attn: General Manager
 P.O. Box 920
 855 West Baseline Road
 Rialto, CA 92377
 Fax: 909-875-1361

To Applicant: Thrifty Oil, Inc
 Attn: Moshe Sassover
 13116 Imperial Highway
 Santa Fe Springs, CA 90670
 (562) 921-3581

With a Copy To: Surety Company
 Attn:
 Address
 Phone Number

Depending upon the method of transmittal, notice shall be deemed received as follows: by facsimile, as of the date and time sent; by electronic mail, as of the date and time sent; by messenger or overnight mail, as of the date delivered; and by U.S. Mail first class postage prepaid, as of 72 hours after deposit in the U.S. Mail.

- 11. a. The Parties shall fully cooperate with one another, and shall take any additional acts or sign any additional documents as may be necessary, appropriate, or convenient to attain the purposes of this Agreement.

- b. No supplement, modification or amendment of this Agreement shall be binding unless executed in writing and signed by both Parties.
- c. This Agreement contains the entire agreement between District and Applicant and supersedes any prior oral or written statements or agreements between District and Applicant.
- d. In the event of any litigation between District and Applicant concerning this Agreement, the prevailing Party as determined by the court shall be awarded its reasonable attorney's fees.
- e. This Agreement shall be binding on the successors and assigns of the Parties.
- f. This Agreement will be executed in multiple counterparts which shall together constitute the complete Agreement.
- g. If any provision of this Agreement shall be ruled invalid, illegal or unenforceable, the Parties shall: (i) promptly negotiate a substitute for the provision which shall, to the greatest extent legally permissible, effect the intent of the Parties in the invalid, illegal or unenforceable provision, and (ii) negotiate such changes in, substitutions for or additions to the remaining provisions of this Agreement as may be necessary in addition to and in conjunction with subsection (i) above to give effect to the intent of the Parties without the invalid, illegal or unenforceable provision. To the extent the Parties are unable to negotiate such changes, substitutions or additions as set forth in the preceding sentence, and the intent of the Parties with respect to the essential terms of the Agreement may be carried out without the invalid, illegal or unenforceable provision, the balance of this Agreement shall not be affected, and this Agreement shall be construed and enforced as if the invalid, illegal or unenforceable provision did not exist.
- h. This Agreement is entered into within the State of California, and all questions concerning the validity, interpretation and performance of any of its terms or provisions or any of the rights or obligations of the Parties hereto shall be governed by and resolved in accordance with the laws of the State of California.
- i. The terms and provisions set forth in this Agreement shall be deemed provisions, terms and/or covenants running with Cedar and Orange Business Center in accordance with applicable law and whereupon all such rights and obligations shall pass to and be binding upon such assignee as the successor owner(s) of Cedar and Orange Business Center. This Agreement shall burden Cedar and Orange Business Center and is binding upon the Parties and their successors, assigns and all persons

acquiring ownership of any interest in, or any portion of Cedar and Orange Business Center. This Agreement shall benefit Cedar and Orange Business Center and inure to the benefit of the owners of Cedar and Orange Business Center. Any such assignees As such, all successor owners of Cedar and Orange Business Center shall have all any of the rights, responsibilities and liabilities of Applicant, as if such person or entity originally executed this Agreement in place and stead of Applicant. Each and every contract, deed or other instrument hereafter executed covering or conveying Cedar and Orange Business Center, or any portion thereof, shall conclusively be held to have been executed, delivered and accepted subject to such terms and conditions regardless of whether such terms and conditions are set forth in such contract, deed or other instrument. No transfer of Cedar and Orange Business Center shall relieve Applicant of any responsibility or liability under this Agreement unless the Assignee expressly assumes all of Applicant's rights and obligations hereunder by written assignment and assumption agreement in a form approved the City, which approval shall not be unreasonably withheld. Applicant may assign its right to receive a reimbursement under this Agreement after the Facilities have been completed and accepted by the District and with the prior written consent of the District, which consent shall not be unreasonably withheld.

- k. The provisions of the Agreement shall be construed as to their fair meaning, and not for or against any Party based upon any attribution to such Party as the source of language in question.
- l. Time is of the essence of this Agreement and each and every term and provision thereof.
- m. This Agreement shall be construed as if prepared by all of the Parties. Accordingly, any rule of law (including California Civil Code Section 1654) or legal decision that would require interpretation of any ambiguities in this Agreement against the Party that has drafted it is not applicable and is waived.
- n. No delay on the part of any Party hereto in exercising any right, power or privilege hereunder shall operate as a waiver thereof, nor shall any waiver on the part of any Party hereto of any right, power or privilege hereunder operate as a waiver of any other right, power or privilege hereunder, nor shall any single or partial exercise of any right, power or privilege hereunder, preclude any other or further exercise of any other right, power or privilege hereunder.
- o. Each individual executing this Agreement hereby represents and warrants that he or she has the full power and authority to execute this Agreement on behalf of the named Parties.

- p. Applicant shall maintain and make available for inspection by District during regular office hours, accurate records pertaining to the design, construction and installation of the Facilities.
- q. The Parties agree that any action or proceeding to enforce or relating to this Agreement shall be brought exclusively in the State courts located in San Bernardino County, California, or the Federal court located in Riverside County, California and the Parties hereto consent to the exercise of personal jurisdiction over them by any such courts for purposes of any such action or proceeding.

IN WITNESS WHEREOF, the Parties have executed this Agreement on the date and year hereinabove written.

WEST VALLEY WATER DISTRICT

Thrifty Oil, Inc.,
a California Corporation.

By: _____
Name: Clarence Mansell
Its: Interim General Manager

By: Thrifty Oil, Inc.,
a California Corporation.

By: _____
Name: Moshe Sassover
Its: Co-CEO

EXHIBIT LIST

EXHIBIT "A"	LEGAL DESCRIPTION OF APN 0253-171-16
EXHIBIT "B"	DESCRIPTION AND LOCATION OF FACILITIES
EXHIBIT "C"	DESCRIPTION AND LOCATION OF REIMBURSABLE FACILITIES
EXHIBIT "D"	MITIGATED NEGATIVE DECLARATION
EXHIBIT "E"	DEPICTION OF BILL OF SALE FORM
EXHIBIT "F"	INSURANCE CERTIFICATE AND ENDORSEMENT FORM

EXHIBIT "A"**Description of APN: 0253-171-16**

THE LAND REFERRED TO IN THIS COMMITMENT IS SITUATED IN THE UNINCORPORATED AREA OF THE COUNTY OF SAN BERNARDINO, STATE OF CALIFORNIA, AND IS DESCRIBED AS FOLLOWS:

PARCEL 1 OF PARCEL MAP NO. 15729, IN THE COUNTY OF SAN BERNARDINO, STATE OF CALIFORNIA, AS SHOWN BY MAP FILE IN BOOK 199, PAGES 84 THROUGH 86 OF PARCEL MAPS, IN THE OFFICE OF THE COUNTY RECORDER OF SAID COUNTY.

EXCEPTING THEREFROM SAID LAND ALL COAL, OIL AND OTHER MINERALS WITHIN OR UNDERLYING SAID LAND AS DESCRIBED THEREIN, HOWEVER WITHOUT THE RIGHT TO USE THE SURFACE, AS RESERVED BY LOS ANGELES & SALT LAKE RAILROAD COMPANY, A UTAH CORPORATION IN A DEED RECORDED NOVEMBER 29, 1944 IN BOOK 1725, PAGE 220 OF OFFICIAL RECORDS.

ALSO EXCEPTING THEREFROM SAID LAND ALL URANIUM, THORIUM AND OTHER FISSIONABLE MATERIALS, ALL OIL, GAS, PETROLEUM, ASPHALTUM, AND OTHER HYDROCARBON SUBSTANCES AND OTHER MINERALS AND MINERAL ORES OF EVERY KIND AND CHARACTER, WHETHER SIMILAR TO THESE HEREIN SPECIFIED OR NOT, WITHIN OR UNDERLYING, OR WHICH MAY BE PRODUCED FROM THE HEREINABOVE DESCRIBED LAND, TOGETHER WITH THE RIGHT TO USE THAT PORTION ONLY OF SAID LAND WHICH UNDERLINES A PLANE PARALLEL TO AND 500 FEET BELOW THE PRESENT SURFACE OF SAID LAND, FOR THE PURPOSE OF PROSPECTING FOR, DEVELOPING AND/OR EXTRACTING SAID URANIUM, THORIUM, AND OTHER FISSIONABLE MATERIALS, OIL, GAS, PETROLEUM, ASPHALTUM, AND OTHER MINERAL OR HYDROCARBON SUBSTANCES FROM SAID LAND, IT BEING EXPRESSLY UNDERSTOOD AND AGREED THAT THERE SHALL BE NO RIGHT TO ENTER UPON THE SURFACE OF SAID LAND, OR TO USE SAID LAND OR ANY PORTION THEREOF TO SAID DEPTH OF 500 FEET, FOR ANY PURPOSE WHATSOEVER, AS RESERVED BY SOUTHERN CALIFORNIA EDISON COMPANY, A CORPORATION IN A DEED RECORDED MAY 3, 1972 IN BOOK 7923, PAGE 366 OF OFFICIAL RECORDS.

ALSO EXCEPTING THEREFROM SAID LAND ALL MINERALS AND MINERAL RIGHTS, INTERESTS, AND ROYALTIES, INCLUDING, WITHOUT LIMITING, THE GENERALITY THEREOF, OIL, GAS AND OTHER HYDROCARBON SUBSTANCES, AS WELL AS METALLIC OR OTHER SOLID MINERALS, IN AND UNDER THE PROPERTY; HOWEVER, GRANTOR OR ITS SUCCESSORS AND ASSIGNS, SHALL NOT HAVE THE RIGHT FOR ANY PURPOSE WHATSOEVER TO ENTER UPON, INTO OR THROUGH THE SURFACE OF SAID PROPERTY IN CONNECTION THEREWITH OR THE SUBSURFACE THEREOF TO A DEPTH OF

500 FEET, AS THE SAME WAS RESERVED BY SOUTHERN PACIFIC TRANSPORTATION COMPANY, A DELAWARE CORPORATION IN THE DEED RECORDED DECEMBER 4, 1990 AS INSTRUMENT NO. 90-478369 OF OFFICIAL RECORDS.

APN: 0253-171-16-0-000

EXHIBIT “B”

DESCRIPTION AND LOCATION OF FACILITIES

1. Cedar Pl to Cedar Ave: 621 lf of 12” Ductile Iron Pipe.
2. Cedar Ave to Orange St: 213 lf of 12” Ductile Iron Pipe.

CEDAR AND ORANGE BUSINESS CENTER

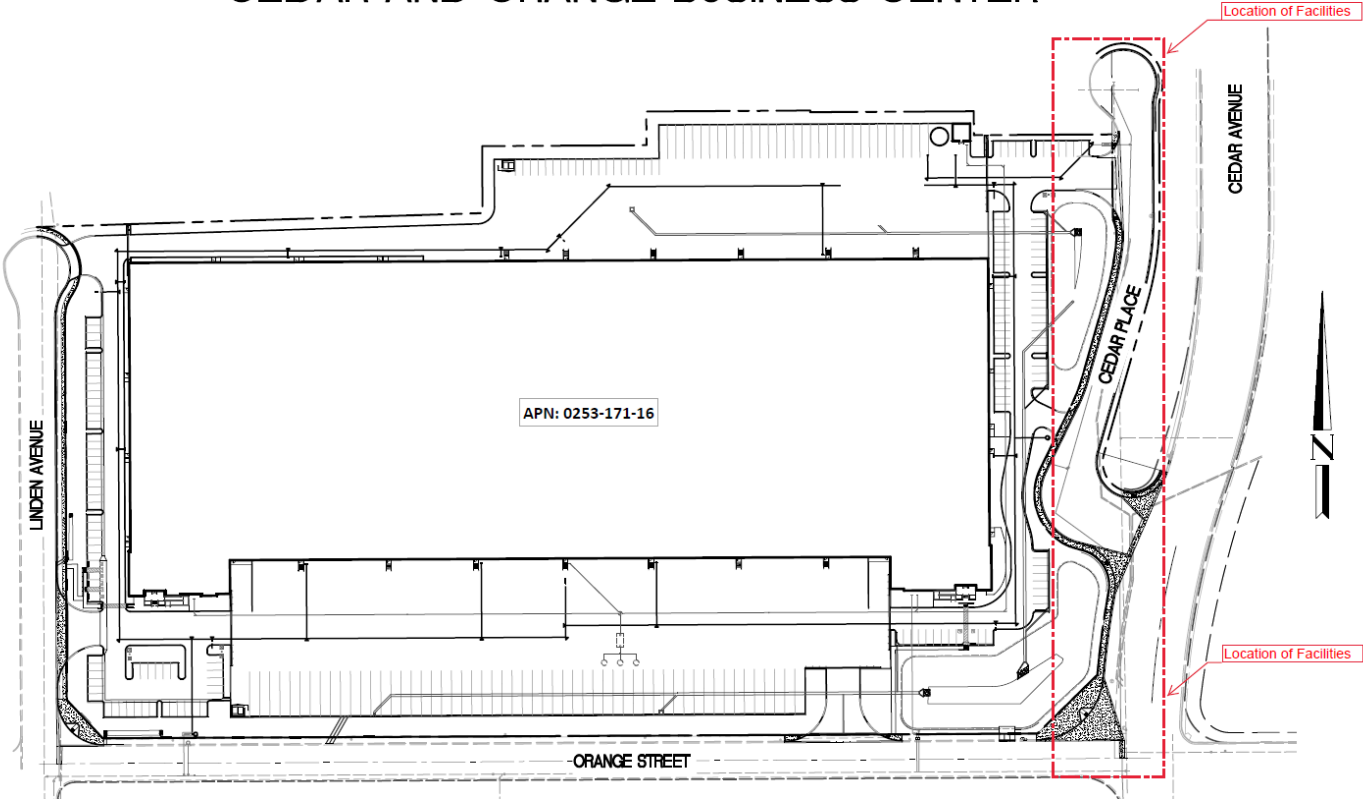

EXHIBIT “C”**DESCRIPTION AND LOCATION OF THE REIMBURSABLE FACILITIES**

The Reimbursable Facilities consist of the following:

1. The oversizing of the waterline in Cedar Place from the eight inch (8”) cross located at the north end of the cul-de-sac to Cedar Avenue. From eight inches (8”) to twelve inches (12”); and
2. The installation of twelve inch (12”) waterline in Cedar Avenue. From the intersection of Cedar Place and Cedar Avenue to the point of connection at the ten inch (10”) water line in Orange Street.

CEDAR AND ORANGE BUSINESS CENTER

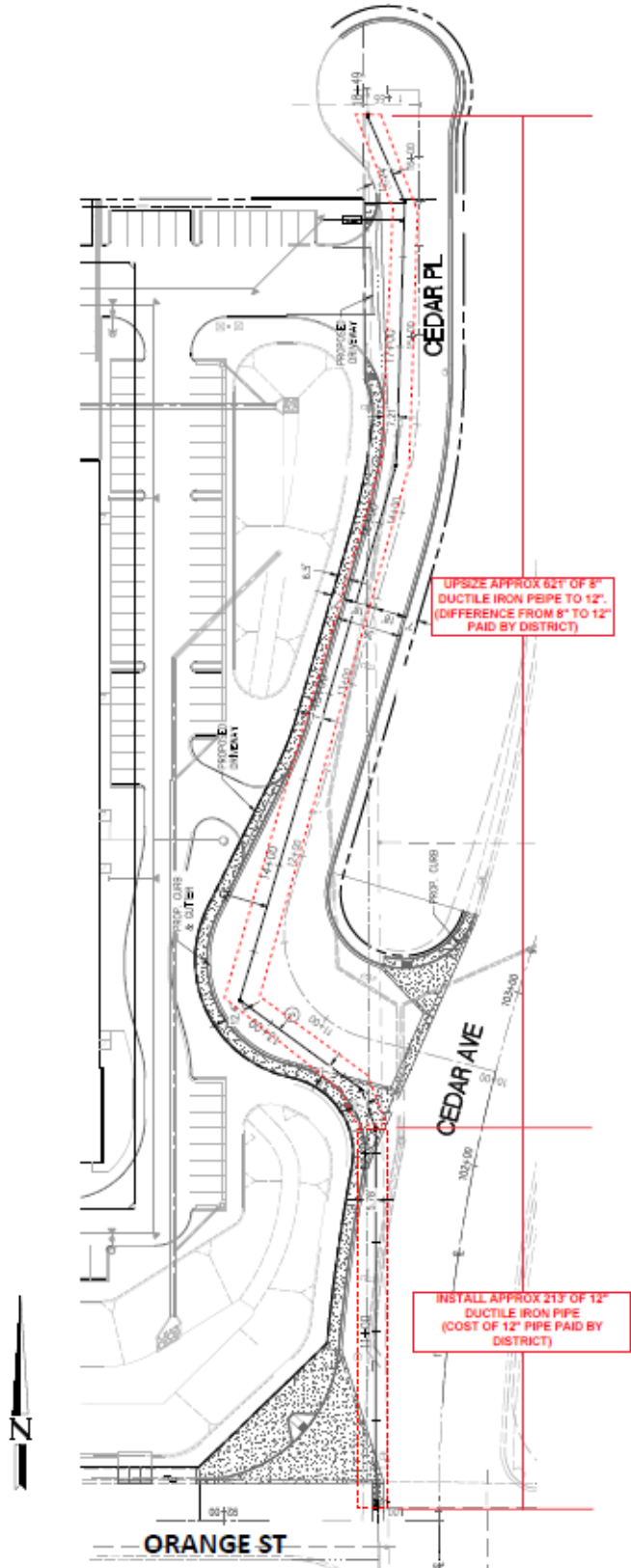

EXHIBIT "D"
MITIGATED NEGATIVE DECLARATION

EXHIBIT "E"

BILL OF SALE

This Bill of Sale, Assignment, and Assumption Agreement is given pursuant to that certain Reimbursement Agreement dated as of _____, 20__ (the "Agreement"), by and between Thrifty Oil, Inc., a California Corporation ("Assignor) and West Valley Water District, a public agency of the State of California ("Assignee"), providing for, among other things, the conveyance of the Facilities as described in the Agreement.

NOW THEREFORE FOR VALUABLE CONSIDERATION, receipt and adequacy of which are hereby acknowledged, Assignor hereby sells, transfers, assigns, and conveys to Assignee, the following:

1. All right, title, and interest of Assignor in and to all of the Facilities as described in the Agreement and more particularly described in Exhibit A attached hereto.
2. This Bill of Sale, Assignment, and Assumption Agreement may be executed in one or more identical counterparts, each of which such counterpart shall be deemed an original for all purposes and all such counterparts shall collectively constitute the complete Bill of Sale, Assignment, and Assumption.

IN WITNESS WHEREOF, Assignor has executed this Bill of Sale, Assignment, and Assumption Agreement as of _____, 20__.

THRIFTY OIL, INC,
a California Corporation

Thrifty Oil, Inc.,
a California Corporation.

By: _____
Name: Moshe Sassover
Its: Co-CEO

Dated: _____, 20__

ASSUMPTION

AS OF THE DATE FIRST WRITTEN, ASSIGNEE HEREBY ACCEPTS THE FOREGOING BILL OF SALE, ASSIGNMENT, AND ASSUMPTION AGREEMENT.

ASSIGNEE:

WEST VALLEY WATER DISTRICT

By: _____
Name: Clarence Mansell
Its: Interim General Manager

Dated: _____, 20__

EXHIBIT A TO BILL OF SALE

1. Cedar Place to Cedar Ave: 621 lf of 12" Ductile Iron Pipe.
2. Cedar Ave to Orange St: 213 lf of 12" Ductile Iron Pipe.

CEDAR AND ORANGE BUSINESS CENTER

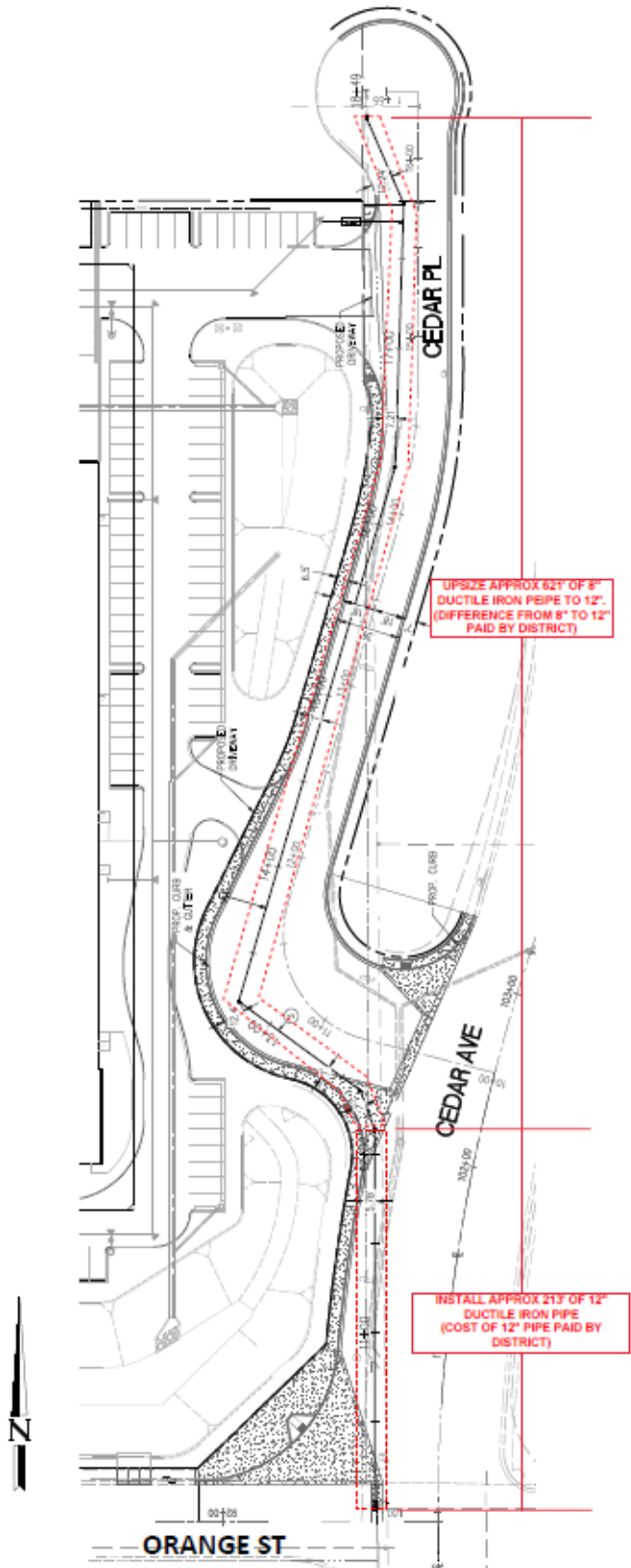

EXHIBIT "F"

INSURANCE CERTIFICATE AND ENDORSEMENT FORM



**BOARD OF DIRECTORS
ENGINEERING AND PLANNING COMMITTEE
STAFF REPORT**

DATE: March 11, 2020
TO: Engineering and Planning Committee
FROM: Clarence Mansell Jr., General Manager
SUBJECT: CONSIDER NOTICE OF COMPLETION RECORDATION FOR THE
CONSTRUCTION OF THE BLOOMINGTON AREA WATERLINE
REPLACEMENT PHASE 3A PROJECT

BACKGROUND:

Distribution mains, services and valves serving a portion of the community of Bloomington are located within the rear alleyways of the homes. Over the course of many years, fences, and buildings have been constructed within these alleyways limiting West Valley Water District's ("District") ability to read meters, locate shut off valves and perform regular and emergency maintenance.

To address this, the District initiated an infrastructure improvement project that includes construction of new water lines and connections to existing waterlines within the existing street right-of-way and paved area.

DISCUSSION:

On June 13, 2019, the District entered into an Agreement with El-Co Contractors, Inc ("El-Co") for the construction of the Bloomington Area Waterline Replacement Phase 3A Project. Since their contract was established, El-Co has successfully conducted the scope of work and provided deliverables as stated in the contract.

The District's Project Manager on the project, Bertha Perez, P.E., has confirmed the substantial completion of the Bloomington Area Waterline Replacement Phase 3A Project. Attached as **Exhibit A** is a copy of the certificate of substantial completion.

FISCAL IMPACT:

No fiscal impact. This project was a budgeted item in the Fiscal Year 2019/20 Capital Improvement Budget under the Bloomington Area Waterline Replacement Phase 3A project.

STAFF RECOMMENDATION:

It is recommended that the Engineering, Operations, and Planning Committee authorize staff to file the Notice of Completion for the project.

Respectfully Submitted,



Clarence Mansell Jr, General Manager

RMG:ce

ATTACHMENT(S):

1. Exhibit A - Notice of Substantial Completion for Bloomington Area Waterline Replacement Phase 3A

EXHIBIT A

CERTIFICATE OF SUBSTANTIAL COMPLETION

Owner:	West Valley Water District	Project:	Zone 2 – Bloomington Phase 3A Waterline Replacement
Contractor:	El-Co Contractors, Inc.		
Construction Manager:	Michael Baker International Inc. - Patrick Hanify,		
	P.E. CCM, QSD/P		
Inspector:	ERSC – Mark Korando		

This Certificate of Substantial Completion applies to:

- All Work The following specified portions of the Work:

March 4th, 2020

Date of Substantial Completion

The Work to which this Certificate applies has been inspected by authorized representatives of Owner, Contractor, Inspector and Construction Manager, and found to be substantially complete. The Date of Substantial Completion of the Work or portion thereof designated above is hereby established, subject to the provisions of the Contract pertaining to Substantial Completion. The date of Substantial Completion in the Certificate of Substantial Completion marks the commencement of the contractual correction period and applicable warranties required by the Contract.

The responsibilities between Owner and Contractor for security, operation, safety, maintenance, heat, utilities, insurance, and warranties upon Owner's use or occupancy of the Work shall be as provided in the Contract.

This Certificate does not constitute an acceptance of Work not in accordance with the Contract Documents, nor is it a release of Contractor's obligation to complete the Work in accordance with the Contract.

EXECUTED BY PROJECT MANAGER:		RECEIVED:	RECEIVED:
By: <u>Bertha Perez</u> (Authorized signature)	By: <u>Patrick Hanify</u> (Authorized Signature)	By: <u>John Wiles</u> Contractor (Authorized Signature)	
Name: <u>Bertha Perez, P.E.</u>	Name: <u>Patrick Hanify, P.E., CCM, QSD/P</u>	Name: <u>John Wiles</u>	
Title: <u>Project Manager</u>	Title: <u>Construction Manager</u>	Title: <u>General Manager</u>	
Date: <u>3/4/2020</u>	Date: <u>3/4/2020</u>	Date: <u>3/4/2020</u>	



**BOARD OF DIRECTORS
ENGINEERING AND PLANNING COMMITTEE
STAFF REPORT**

DATE: March 11, 2020
TO: Engineering and Planning Committee
FROM: Clarence Mansell Jr., General Manager
SUBJECT: CONSIDER A COMMON USE AGREEMENT WITH THE CITY OF RIALTO FOR THE CACTUS TRAIL

BACKGROUND:

The City of Rialto (“Rialto”) is in the conceptual design stage for a community bicycle and pedestrian trail. The design concept for the Cactus Trail, focuses on “water” and the history and development of the water canal system of Rialto. From the north trailhead monument at Baseline Road, to the southern trailhead monument at Rialto Avenue, interpretive signs will be placed at strategic locations highlighting a period of Rialto history. These displays will walk the users of the trail down the timeline of water development in Rialto. As water flows from the north canyons to the south agricultural fields and citrus groves, so will the historic timeline of water and agricultural irrigation in Rialto. Starting from the early Serrano inhabitants to today’s residents, the Cactus Trail will focus on the importance of this resource; it’s history, and conveyance within this arid region of Southern California.

The Cactus Trail will include stone veneered Cactus Trail Monuments with water features, weathered metal trail signage, cactus accents, landscape boulders and decomposed granite paths. Pedestrian nodes will be placed between major intersections with enhanced paving illustrating various Cactus Trail themes in concrete, pedestrian seating areas, decorative cobble paving, landscape boulders and accent planting.

DISCUSSION:

In order to extend the Cactus Trail from Rialto Avenue to Base Line Road, a proposed 10-foot wide meandering pedestrian walkway would cross over West Valley Water District’s (“District”) reservoir site property on Cactus Avenue.

The City of Rialto would like to enter into a Common Use Agreement with the District for use of the District’s property (APN 0128-121-33 and APN 0128-121-39) adjacent to Cactus Avenue for the Cactus Trail. Existing bollards, keypads and air-vac canister will be protected in place. There will be no impact to the existing chain link fencing. The existing wooden rail fence will be replaced by a rail fence that will extend the length of the trail. Attached, as Exhibit A are renderings of the project, proposed signage at the gate entrance and a topographic map showing the driveway and appurtenances. Attached, as Exhibit B is a copy of the Common Use Agreement.

FISCAL IMPACT:

No fiscal impact.

STAFF RECOMMENDATION:

It is recommended that the Engineering, Operations and Planning Committee approve the Common Use Agreement with the City of Rialto, and have this item considered by the full Board of Directors at a future meeting.

Respectfully Submitted,



Clarence Mansell Jr, General Manager

LJ:ce

ATTACHMENT(S):

1. Exhibit A - Trail Concepts
2. Exhibit B - Common Use Agreement

EXHIBIT A

REGULAR TRAIL



CACTUS AVENUE

MOW CURB

MULTI USE TRAIL

PLANTER

PVC 2- RAIL FENCE

DG PLANTER



California Gold Decomposed Granite



Boulders



Adobe Sunset Decomposed Granite



PVC 2-Rail Fence



Parkinsonia aculeata Desert Museum Palo Verde Tree



Cistus x purpureus Orchid Rockrose



Callistemon 'Little John' Dwarf Callistemon



Artemisia 'Powis Castle' Wormwood



Caesalpinia gilliesii Mexican Bird of Paradise



Chitalpa tashkentensis Chitalpa



Cercis canadensis 'Forest Pansy' Forest Pansy Redbud



Baccharis x 'Centennial' Centennial Coyote Brush



Rosa x 'Noala' Flower Carpet* Coral Groundcover Rose



Festuca 'Siskiyou Blue' Siskiyou Blue Fescue



Agave americana Century Plant



Aloe striata Coral Aloe



Hesperaloe parviflora Red Yucca



Rosmarinus officinalis 'Huntington Carpet' Huntington Carpet Rosemary

REGULAR TRAIL
CACTUS TRAIL RIALTO, CALIFORNIA



CROSSING AT DRIVEWAY PAINTED MEDIAN

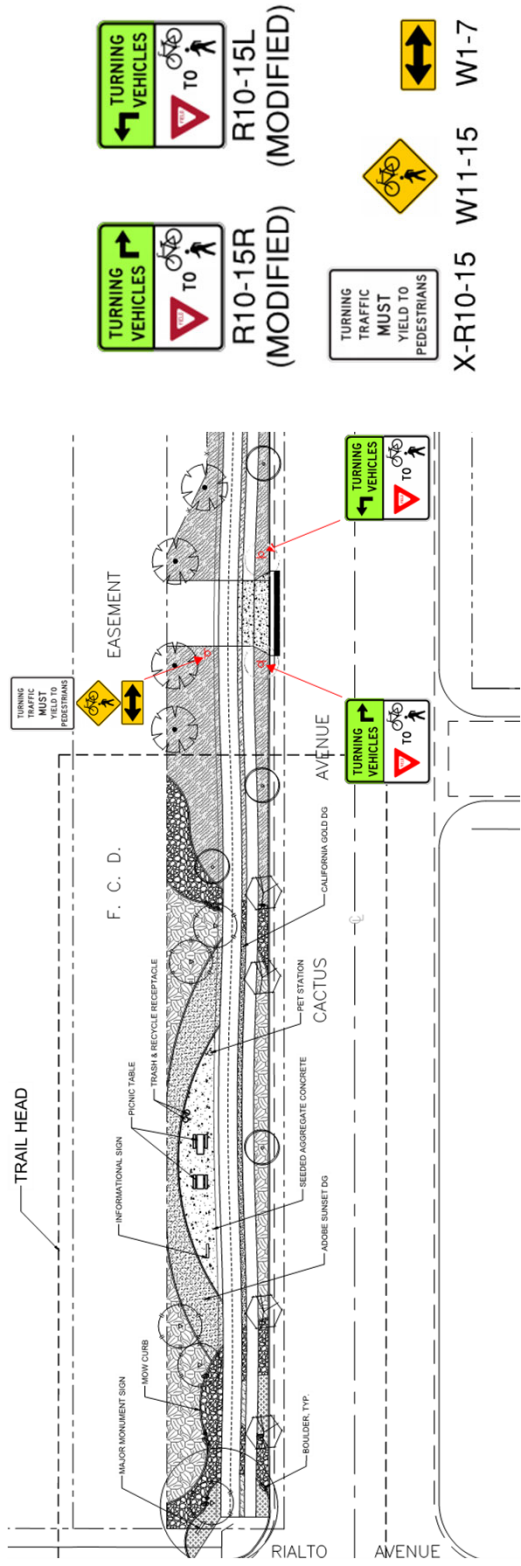

Goleta, CA

Conceptual Design Concept

Water has played a vital role in the development of the City of Rialto. Long before the arrival of the Mexican and European settlers, the Serrano people, a Native American tribe of this region, inhabited the area known as the "bench" adjacent to the Lytle Creek Wash. This land was fertile and provided a yearlong supply of water to these people and the game they hunted.

Early settlers of the mid 1800's built their homes on the rich sandy loam soils of the "bench". Nearby springs and artesian wells seeped out water, and helped to provide additional summer irrigation for the early agricultural crops of Rialto. As the population grew, the demand for water supply increased. The delivery of water for irrigation and the management and battles over water rights, helped to shape Rialto and the businesses and corporations that settled there.

The design concept for the Cactus Trail focuses on "water" and the history and development of the water canal system of Rialto. From the north trailhead monument at Baseline Road, to the southern trailhead monument at Rialto Avenue, interpretive signs are placed at strategic locations highlighting Rialto history. These displays will walk the users of the trail down the timeline of water development in Rialto. As water flows from the north canyons to the south agricultural fields and citrus groves, so will the historic timeline of water and agricultural irrigation in Rialto. Starting from the early Serrano inhabitants to today's residents, the Cactus Trail will focus on the importance of this resource; it's history, and conveyance within this arid region of Southern California.

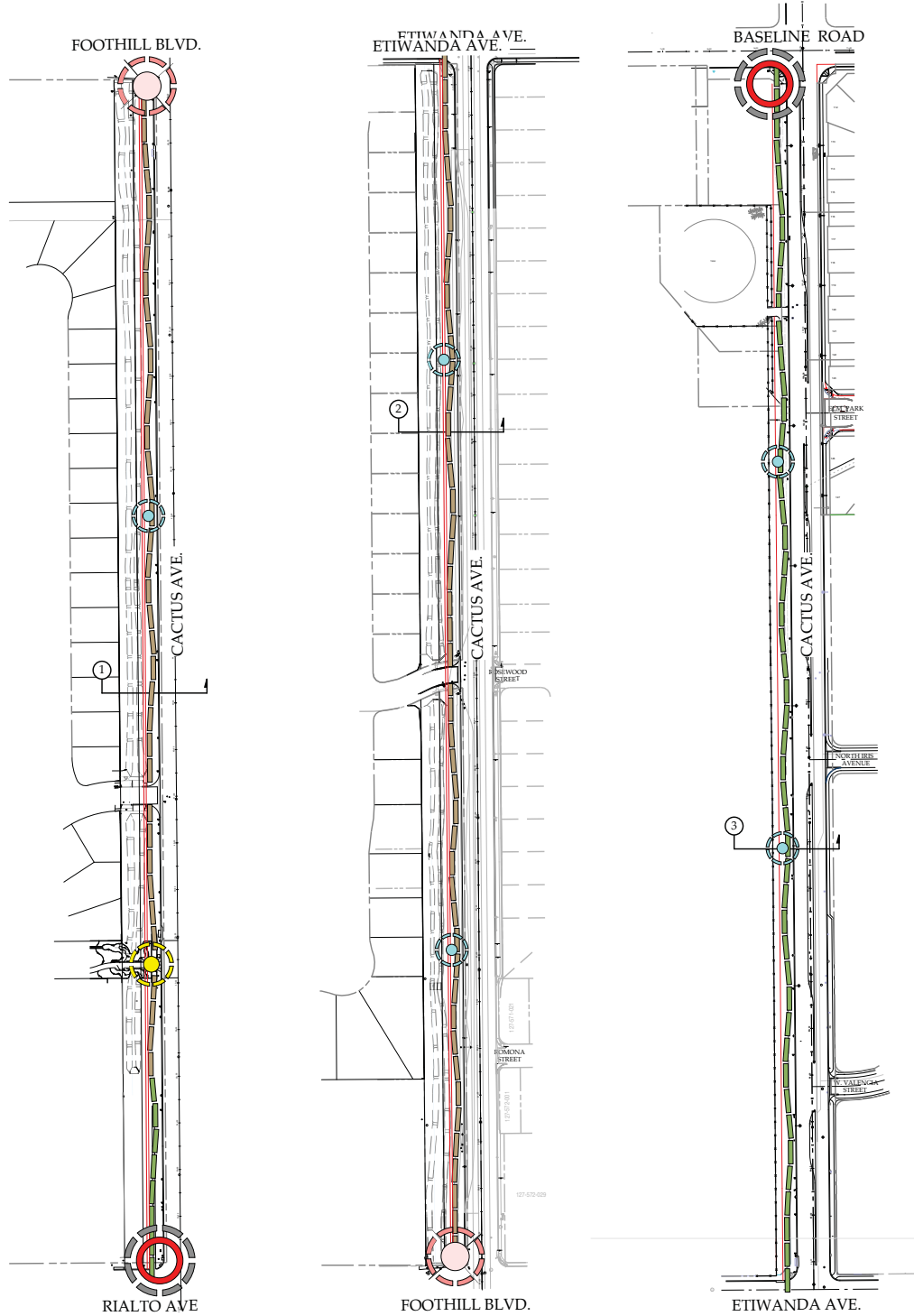

OVERALL CONCEPTUAL LANDSCAPE MASTER PLAN CACTUS AVENUE TRAIL CITY OF RIALTO RIALTO, CALIFORNIA



FEATURE LEGEND:

Primary Trail Monument
Trail markers at Rialto Avenue and Baseline Road. Stone engraved Cactus Trail Monument with water feature (see Monument Perspective A and Monument Elevation B), weathered metal trail signage, cactus accents, landscape boulders and decomposed granite path. See Enlargements C and D.

Secondary Trail Monument
Cactus Trail Monument at Etiwanda Avenue with landscape boulders, accent planting and decomposed granite path. See Monument Enlargement and Elevation E.

Cactus Avenue at Rails to Trails Project Intersection
Connection to Rails to Trails Project along the Rialto canal with accent cobble, landscape boulders and accent planting. See Enlargement C.

Pedestrian Trail Node
Pedestrian nodes between major intersections with enhanced paving and decorative cobble paving, landscape boulders and accent planting. See Enlargement H.

Pedestrian Trail
10' wide pedestrian trail along adjacent to earthen flood control channel.

Pedestrian Trail
10' wide pedestrian trail along Cactus Ave, adjacent to abandoned rail road track north of Rialto Ave. and adjacent to West Valley Water District.

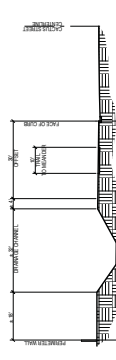

1 CACTUS AVE SECTION
(Station Point 43+21) SCALE: 1" = 20'



2 CACTUS AVE SECTION - BETWEEN
FOOTHILL BLVD AND ETIWANDA AVE
(Station Point 75+20) SCALE: 1" = 20'

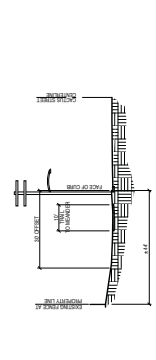

3 CACTUS AVE SECTION
(Station Point 92+85) SCALE: 1" = 20'

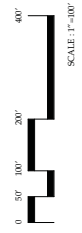

3.f.a

Date: October 2010
AUC/DIR/ETB/2



CACTUS AVE (45MPH)

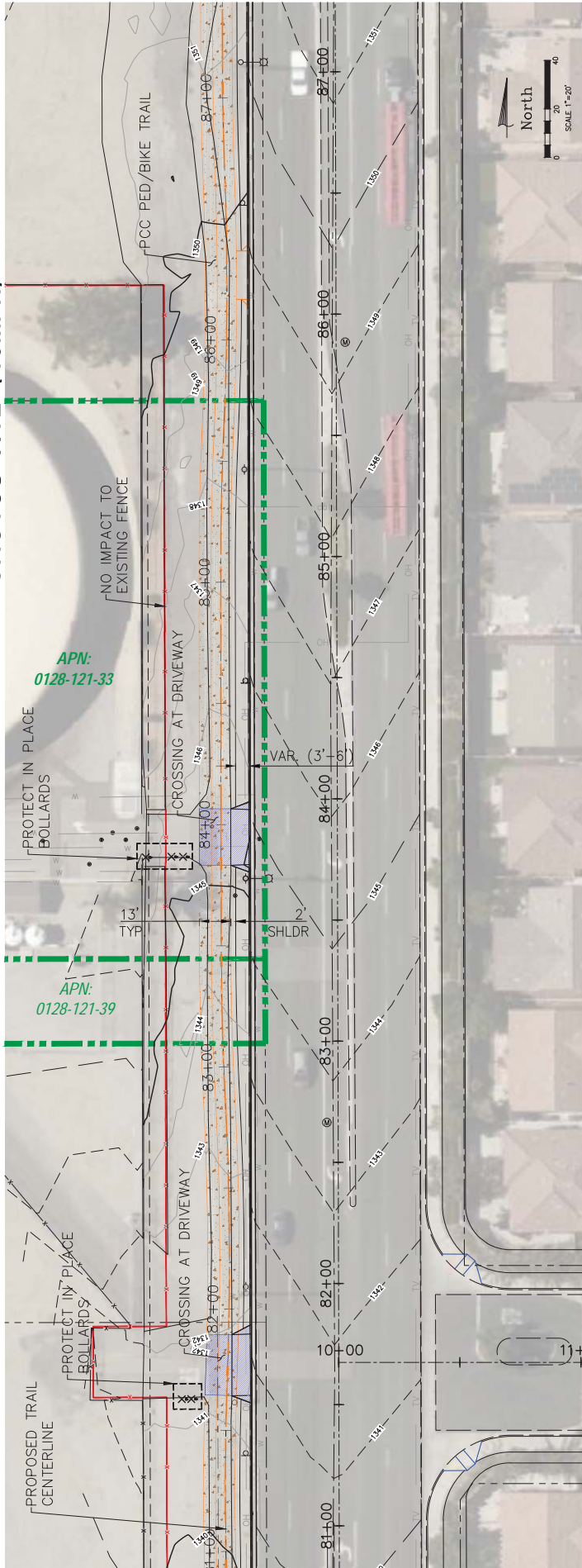

ELM PARK AVE.

EXHIBIT B



**BOARD OF DIRECTORS
ENGINEERING AND PLANNING COMMITTEE
STAFF REPORT**

DATE: March 11, 2020
TO: Engineering and Planning Committee
FROM: Clarence Mansell Jr., General Manager
SUBJECT: CONSIDER REMOVAL OF APN 175-170-040 AND 175-200-001 FROM WEST VALLEY WATER DISTRICT SERVICE AREA

BACKGROUND:

Crestmore Redevelopment, LLC. (“Developer”) is the owner of land located in Riverside County, on the southeast corner of Rubidoux Boulevard/Cedar Avenue and El Rivino Road in the City of Jurupa Valley, known as Agua Mansa Commerce Center (“Development”), as shown in **Exhibit A**. The Project is proposing to build an industrial park on approximately 303 acres of land, with six (6) buildings totaling 3.4 million square feet. The entire project site will be serviced by the Rubidoux Community Services District (“RCSD”), and will require domestic, irrigation, and fire service connections.

DISCUSSION:

The proposed Development consists of approximately eighteen (18) parcels which are mostly within the RCSD service area, with the exception of two (2) parcels of land totaling nineteen (19) acres which are located along El Rivino Road at the District’s southern boundary. As identified in the projects Plan of Service, the outlying parcels would need to be removed from the West Valley Water District (“WVWD”) service area in order to complete the lot consolidation required for the project, and to allow RCSD to provide water service to the entire project. As part of the Development’s entitlement process, the Plan for Service, attached as **Exhibit B**, will need to be approved by the WVWD Board of Directors, before being accepted by the Land Agency Formation Commission (“LAFCO”) as required by California Government Code Section 56653.

FISCAL IMPACT:

No fiscal impact.

STAFF RECOMMENDATION:

It is recommended that the Engineering, Operations and Planning Committee approve the removal of APN 175-170-040 and 175-200-001 as shown in the Plan of Service for the Agua Mansa Commerce Center, and have this item considered by the full Board of Directors at a future meeting.

Respectfully Submitted,



Clarence Mansell Jr, General Manager

DG:ce

ATTACHMENT(S):

1. Exhibit A - Aerial Map
2. Exhibit B - Plan of Service for Agua Mansa Commerce Center

EXHIBIT A



Exhibit A El Rivino Rd. Between Cedar Ave and Hall Ave

Rubidoux Community Services District Service Area

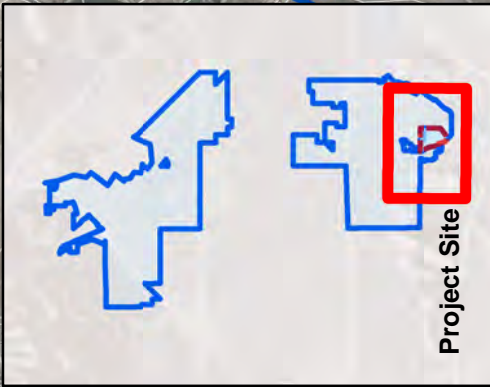
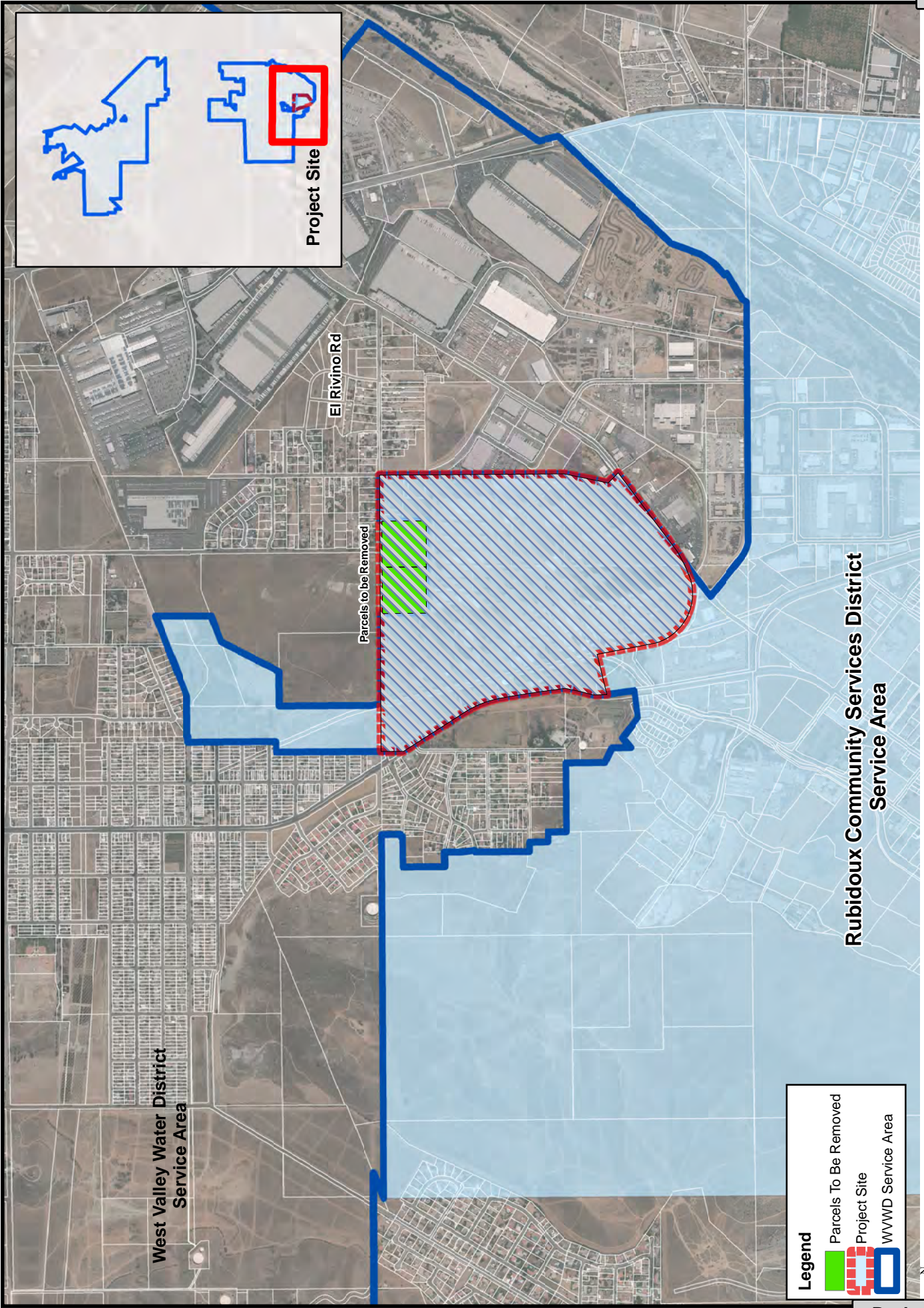

Project Site

El Rivino Rd

Parcels to be Removed

West Valley Water District
Service Area

Legend

- Parcels To Be Removed
- Project Site
- WVWD Service Area

Date: 3/6/2020

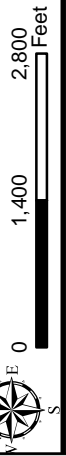

EXHIBIT B

ADDENDUM #1

Rubidoux Community Services District Plan of Services Agua Mansa Commerce Center

Removal of Assessor’s Parcel Numbers 175-170-040 and 175-200-001 from West Valley Water District for Annexation into Rubidoux Community Services District

February 19, 2020

Introduction

Crestmore Redevelopment, LLC (Applicant) is proposing to build an industrial park on the 303± acre site. The annexation is proposed for eighteen (18) existing assessor’s parcels, as follows: APNs 175-170-005, portion of -006,-027, -028, -036, -040, -042, -043, and -046; 175-180-001; and 175-200-001 through -005, and -007 through -009, located on the southeast corner of the intersection of Rubidoux Boulevard and El Rivino Road in the City of Jurupa Valley.

Currently, APNs 175-170-040 and 175-200-001 are within the service area boundaries of West Valley Water District (WVWD). In order to annex these parcels into the service area of Rubidoux Community Services District (RCSD), they must first be removed from the boundaries of WVWD. The exhibits below show the existing and revised boundaries as proposed.

EXISTING BOUNDARIES

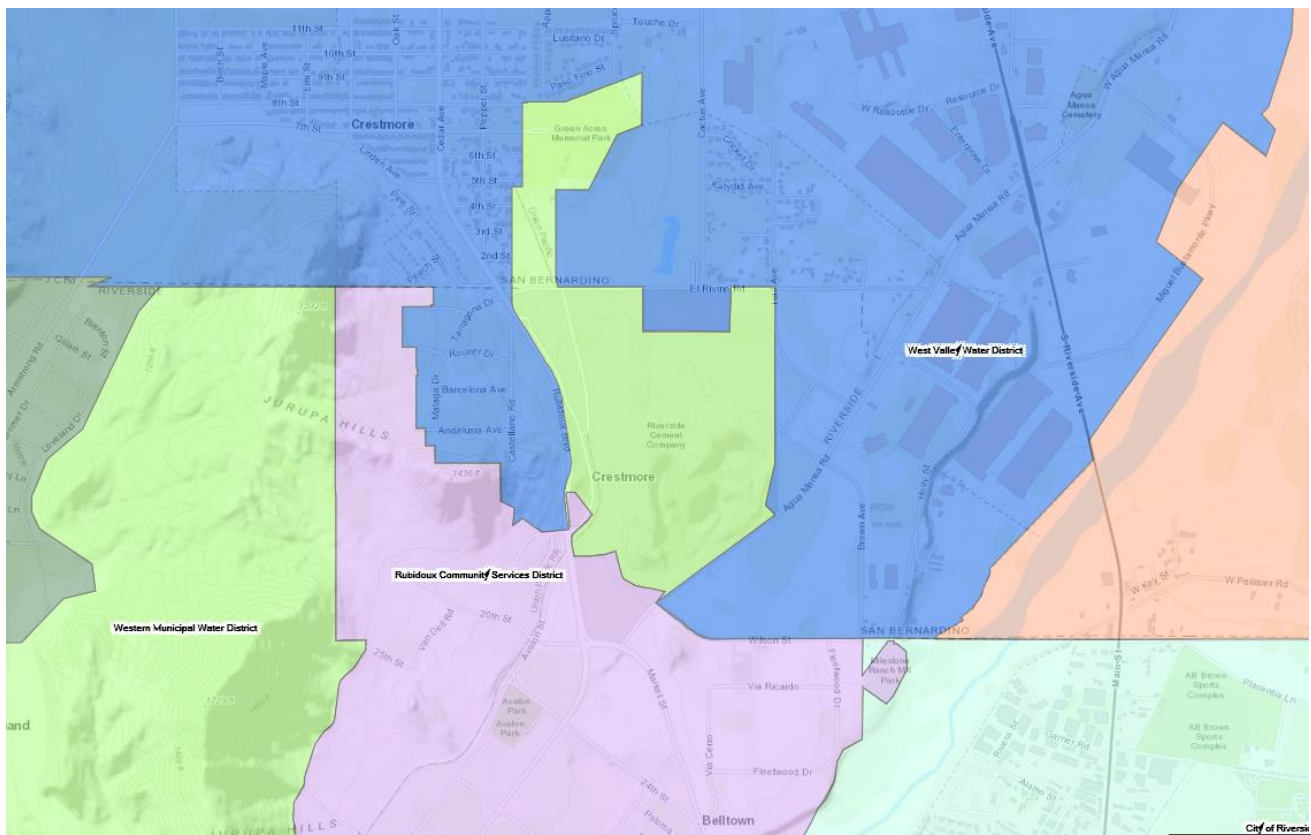

PROPOSED BOUNDARIES

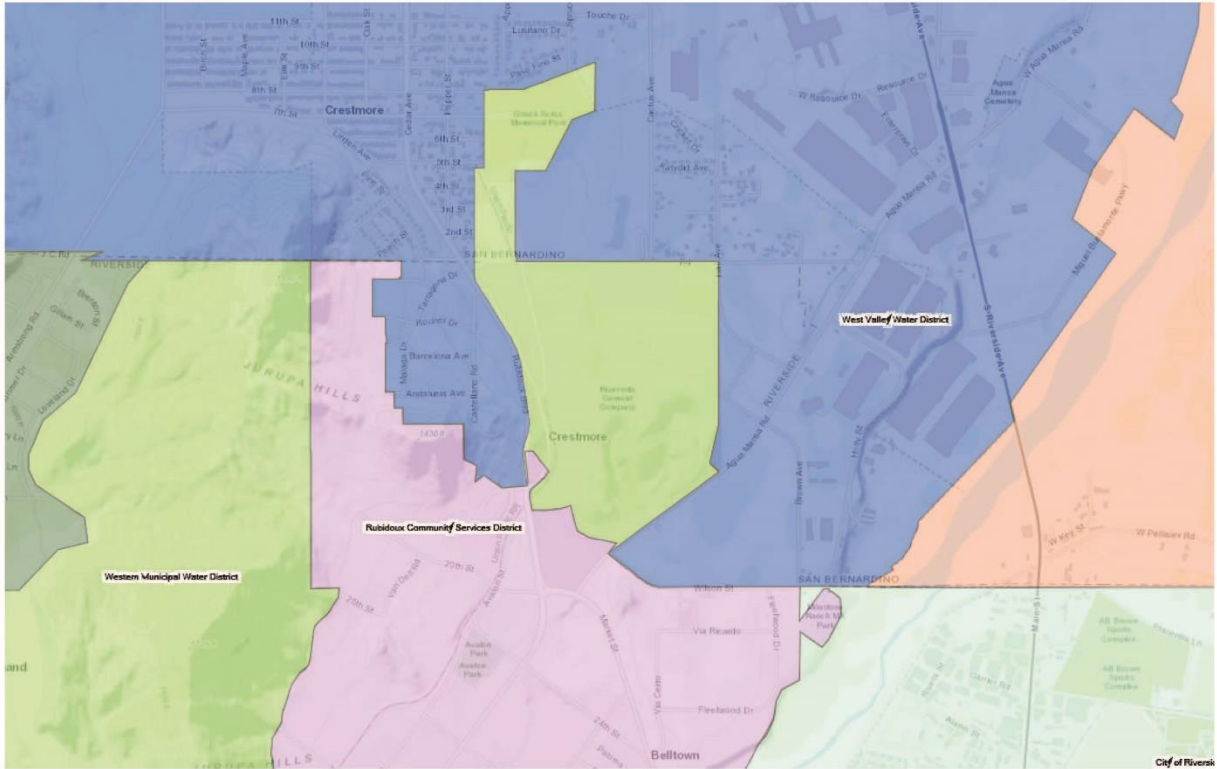

WVWD has reviewed and approved the proposed boundary revisions and has provided their signature below.

By:

 Steven W. Appel, General Manager
 Rubidoux Community Services District

Date: _____

By:

 Clarence C. Mansell, Jr., General Manager
 West Valley Water District

Date: _____

Rubidoux Community Services District Plan of Services Agua Mansa Commerce Center

(Annexation for APNS 175-170-005, portion of -006, -027, -028, -036, -040, -042, -043, -046, 175-180-001, 175-200-001 through -005, and -007 through -009)

October 30, 2019

Introduction

Crestmore Redevelopment, LLC (Applicant) is proposing to build an industrial park on the 303± acre site¹. The annexation is proposed for eighteen (18) existing assessors parcels, as follows: APNs 175-170-005, portion of -006,-027, -028, -036, -040, -042, -043, and -046; 175-180-01 ; and 175-200-001 through -005, and -007 through -009, located on the southeast corner of the intersection of Rubidoux Boulevard and El Rivino Road in the City of Jurupa Valley. The general location of the Project is in the Fontana and South San Bernardino Quadrangle Map, Section 3 of Township 2 South, Range 5 West. The Project Site is approximately 1.4 miles north of Interstate 60 (I-60) and 2.5 miles south of Interstate 10 (I-10). The Project will ultimately be served from the District’s existing Atkinson Pressure Zone. See Figure 1.

All eighteen parcels are to be annexed into the Rubidoux Community Services District (RCSD or “the District”) for Water, Sewer, Fire, Solid Waste, and Street Lighting services. The total annexation area is approximately 290.2 acres. The subject property adjoins the service area of Rubidoux Community Services District (RCSD), and is within the District’s Sphere of Influence.

ANNEXATION MAP

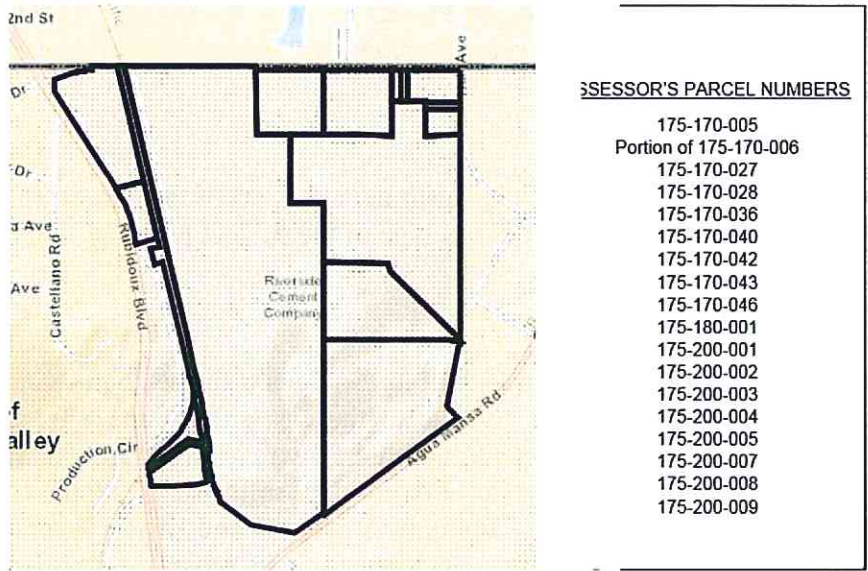

¹ Although the Agua Mansa Commerce Center Specific Plan is approximately 303 acres, the proposed annexation is for 290.2 acres. The remaining 12.8 acres were annexed separately by CalPortland.

Figure 1 – Annexation Boundary

This Plan of Services utilizes information from the District's 2015 Water System Master Plan Update (Master Plan), which addresses water demands and master planned facilities for the Project. This Master Plan is currently being updated. Land use information was obtained from the Riverside County General Plan and the City of Jurupa Valley Planning Department General Plan. The 303± acre site for the proposed industrial development is currently developed with the Riverside Cement Plant, a quarry for the mining of limestone for the manufacture of cement and cement products, and various support buildings. The tentative schedule for the Project has a start date for construction of approximately 2020 with the first occupancy anticipated in 2021.

Fire

RCSD contracts with CalFire and Riverside County Office of Emergency Services to provide fire protection services within RCSD's service area. RCSD will provide fire protection services to the subject property. The closest County fire station is located at 5721 Mission Boulevard, Jurupa Valley, CA 92509, which is approximately 3 miles southwest of the subject property. The Department provides full service municipal and wildland fire protection, pre-hospital emergency medical response by paramedics and emergency medical technicians, technical rescue services, and response to hazardous materials discharges. The applicant/property owner of the subject property shall pay a one-time Fire Mitigation fee (\$0.41 per square foot) to RCSD.

Solid Waste Disposal

The District contracts Solid Waste Collection Services to Burrtec Waste Industries, Inc. solid waste collection service is currently provided by RCSD to properties that are within the RCSD service area. The Burrtec Waste Industries, Inc. yard is located at 1850 Agua Mansa Road, Riverside, CA, which is approximately one mile south of the proposed site. Therefore, RCSD will provide solid waste collection services to the subject property following development of the site.

Street Lighting Service

RCSD provides Street Lighting services to its customers. As part of the annexation into the District's services, the street lights along the frontage of the subject property will be included.

Sewer System Improvements

There is an existing 12-inch sewer line in Rubidoux Boulevard to the southwest of the Site and an existing 8-inch sewer line in Brown Avenue to the east side of the Site. Existing on-site wastewater is conveyed to septic fields on-site with no flow reaching these existing public lines. The Project will install new on-site sewer distribution infrastructure and two new sewer connections to the existing sewer lines in Rubidoux Boulevard and Brown Avenue.. Buildings 1 and 2 will have a minimum of two points of connection in order to accommodate multiple tenants if necessary. Buildings 3, 4, 5, and 6 will have one point of connection.

All wastewater collected by the RCSD is conveyed through regional wastewater conveyance facilities to the City of Riverside Regional Water Quality Control Plant (WQCP). The WQCP is located on Acorn Street in the City of Riverside. The current capacity of the WQCP is 40 million gallons per day (gpd). The RCSD currently flows approximately 2 million gallons of wastewater to the WQCP daily.

The total preliminary estimate for the projected sewage generation for the Project is 8,752 gpd based on the Utility Report dated January 21, 2019 prepared by Langan Engineering. Future quantities of wastewater conveyed by RCSD to the WQCP have been reviewed for the next 25 years and has been noted that the WQCP will have capacity for the anticipated wastewater flows from the proposed Project. Further determination and assessment by RCSD during final sewer engineering design will be conducted to identify the exact sewer discharge flow.

Total Dissolved Solids

The Rubidoux Community Services District (“RCSD”) owns sewer discharge rights through Contracts with the City of Riverside (“City”) for wastewater treatment and disposal at the City’s wastewater treatment plant. RCSD and the City continually monitor the wastewater influent and effluent to ensure compliance with the City’s Wastewater Plants regulatory permits (“Wastewater Permits”), including the levels of Total Dissolved Solids (“TDS”) in the wastewater effluent. TDS includes inorganic and organic salts dissolved in the water and wastewater. TDS occurs naturally with potable water delivered to customers and is often elevated in wastewater from customer and industry use of the potable water. The Wastewater Permits include limits on TDS levels allowed in the wastewater effluent. The City current Wastewater Permit has a maximum TDS limit for discharge of recycled water to the Santa Ana River of 650 mg/l based on a rolling 12-month average.

TDS is naturally occurring in the groundwater within the region, including the RCSD service area. RCSD has been historically, and currently continues to be 100% reliant on groundwater for its source of potable water delivered to its customers. Groundwater pumped within RCSD’s area has a natural ambient TDS of approximately 520 mg/l. This naturally occurring TDS contributes to the concentration of TDS in the wastewater received from within the RCSD service area (“RCSD Wastewater”) and to TDS levels in the wastewater effluent discharged from the City’s wastewater treatment plant. The RCSD is preparing a plan to evaluate TDS levels in the RCSD wastewater and recommend action(s) to reduce TDS levels in the RCSD Wastewater (“TDS Reduction Plan”). TDS levels in wastewater may be controlled through reducing TDS in potable water prior to use by the customer, reduction in customer contribution of TDS (“Customer Use Increment”) and treatment of wastewater. TDS reduction treatment is typically accomplished through filtration or chemical treatment processes: Industries that discharge high TDS wastewater (i.e. Industrial laundries, fabrication plants, etc.) are required to treat their industrial wastewater to decrease TDS levels (and other contaminants), prior to discharge into the public sewer system. RCSD has an existing industrial pre-treatment program that focuses on these industrial discharges. The industrial pre-treatment program complies with the City’s requirements for industrial dischargers. The RCSD TDS Reduction Plan will comprehensively review options to reduce TDS in wastewater delivered to the City. Options anticipated to be included in the TDS Reduction plan are: reduction of TDS in potable water deliveries, and more control on Customer Use Increment.

The Project will be required to comply with the following requirements that will reduce

levels:

1. Any industrial user that generates a high-strength wastewater must apply for a permit and comply with the RCSD Industrial Pre-Treatment program, including all currently adopted limits for the discharge of pollutants as adopted by the RCSD and as applicable to the specific industrial user.
2. a. Comply with the RCSD TDS Reduction Plan; or if the TDS Reduction Plan has not been adopted prior to the issuance of the first building permit; then
 - b. Coordinate with RCSD to develop a plan that will insure wastewater delivered into RCSD's sewer collection system for treatment at the City's Treatment Plant will not have a TDS concentration exceeding 650 mg/l. The TDS control methods will be accomplished using standards mutually agreed to with RCSD and may include TDS removal treatment for potable water delivered to the Project in whole, or for each individual building within the Project. TDS removal is not required for irrigation systems or fire protection systems.

Water System Improvements

The subject property will be served from an existing 24" water main within RCSD's Atkinson Pressure Zone.

The estimated fire flow is 4,000 gpm with a minimum residual pressure of 20 psi at the Project site. The Fire Department will stipulate the required fire flow for the Project.

The Applicant will install a 24-inch fire water and 2-inch potable water mains from Rubidoux Blvd heading east to the site point of connections (meter and detector check) approximately 850 linear feet each. The estimated average day domestic potable water demand for the annexation, for the proposed buildings, is 6.18 gpm.

Non-Potable water

The District does not currently have recycled water in the project area.

Water Supply and Facilities

The District was formed on November 24, 1952. The District's service area is situated in the eastern portion of the City of Jurupa Valley in Riverside County, California, approximately 50 miles east of Los Angeles. The service boundary area is currently 8.5 square miles. The District is bounded by San Bernardino County on the north and west, the Santa Ana River on the south, and the City of Riverside to the east.

Rubidoux Community Services District has over 6,800 metered connections, including 6,400 residential and 400 commercial/industrial uses. One hundred percent (100%) of RCSD's water supply is obtained from groundwater and other outside water sources are not required. RCSD has approximately 50 miles of pipeline with 11 active production wells (6 potable water and 5 non-potable water with 4 storage reservoirs and 2 booster stations.

Presently, the subject property is outside the District's boundary but within the District's s

of influence. As stated above, the District is not currently providing service to any of the proposed parcels or any existing buildings at the site. The existing buildings are using “well water” for non-potable uses and potable water is delivered to the site. There are no connections to any potable or recycled water at the site.

The District’s Water Master Plan recommends that the Atkinson or 1066 RCSD Pressure Zone ultimately serve the Project. Water supply for the 1066 Atkinson pressure zone is from seven RCSD groundwater wells. The seven wells supply water to two storage tanks with a combined capacity of 5 million gallons. The existing Atkinson or 1066 is adequate to provide pressure and water supply for fire flow and domestic service to the Project.

Expected Pressures

Atkinson Pressure Zone

Major backbone facilities in this pressure zone are in place to support the Project. The District’s flow tested hydrant on Avalon St near Rubidoux Blvd, in October 2016, was used to predict system pressures within the Atkinson Pressure Zone for the Project. The District’s flow tested hydrant results indicate that the static pressure was 74 psi. During maximum day plus a fire flow of 4,000 gpm the predicted pressures at the site is estimated to be 20 psi.

Required Potable Water Facility Improvements

The following are the required backbone potable water facilities that must be installed and shall be in accordance with the District’s Master Plan.

- Install a 2-inch potable water main from Rubidoux Blvd heading east to the site point of connection (domestic meter). The 2-inch potable water line shall be terminated at the most westerly property line of the project where the meter is located.
- The applicant shall install all water distribution lines in accordance with District policies and design standards.
- Design and construction of all facilities shall be in accordance with drawings prepared by the Applicant and approved and signed by the District.
- All pipes shall be ductile iron pipe with push-on joints. The minimum pressure class of the pipe shall be Class 150. All pipe and laterals shall be encased in polyethylene bags in accordance with District standards. In addition, the applicant shall install fire hydrants or 4-inch blow-offs at the end of all lines for line flushing.
- The applicant shall install standard 6-inch fire hydrants in accordance with District standards. The Fire Marshall shall approve all 79 fire hydrant locations.
- The applicant shall install minimum 2” copper services from the water main to and including angle meter stop and coupling fitting in accordance with District’s stand

drawings and specifications. All service laterals shall be located horizontally within the public right-of-way and minimum 10 feet clear of all sewer laterals.

Figure 2 – Existing and Proposed Sewer Facilities

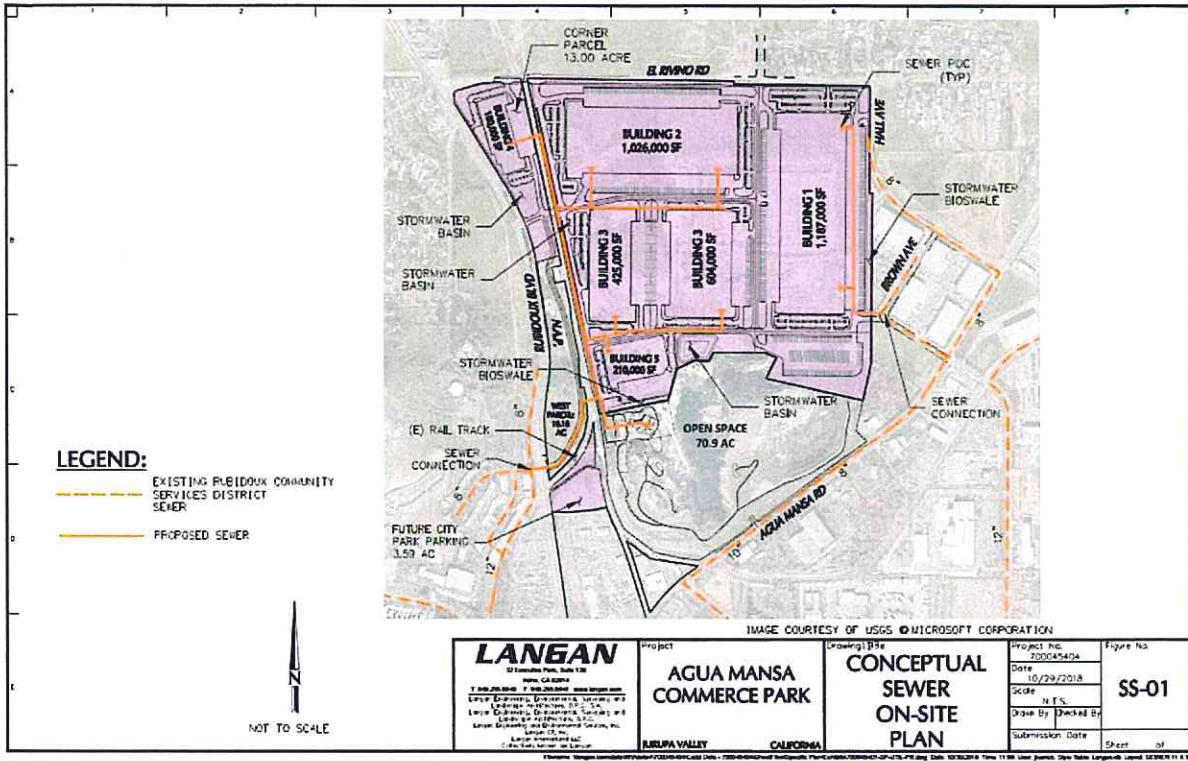
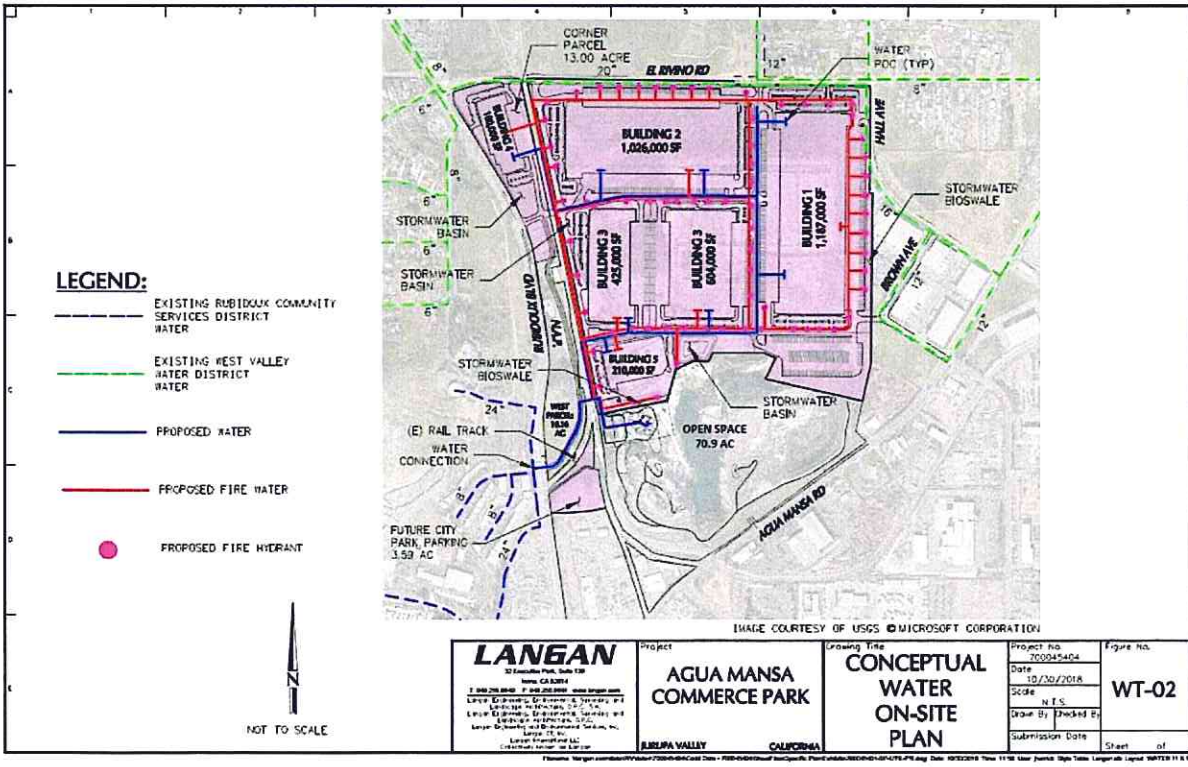

Figure 3 – Existing and Proposed Water Facilities



Recycled Water Facility Improvements

RCSD currently does not have recycled water facilities.

Water Supply

Table 1

Groundwater Production (YEARS 1977 – 2010)

TABLE 6-2 GROUNDWATER SUPPLY RELIABILITY – HISTORIC CONDITIONS (AF/yr)					
Riverside Basin	Normal Water Year (2010)	Single Dry Water Year (1977)	Multiple Dry Water Years		
			2013	2014	2015
Potable Water Wells	14,000	14,000	14,000	14,000	14,000
Non-Potable Water Wells	3,000	3,000	3,000	3,000	3,000
Total Supply	17,000	17,000	17,000	17,000	17,000
Percent of Normal	—	100%	100%	100%	100%

TABLE 6-3 GROUNDWATER SUPPLY RELIABILITY – CURRENT CONDITIONS (AF/yr)				
Riverside Basin	Average/Normal Water Year Supply	Multiple Dry Water Years		
		2016	2017	2018
Potable Water Wells	14,000	14,000	14,000	14,000
Non-Potable Water Wells	3,000	3,000	3,000	3,000
Total	17,000	17,000	17,000	17,000
Percent of Normal	100%	100%	100%	100%

TABLE 6-4 BASIS OF WATER YEAR DATA	
Water Year Type	Base Year(s)
Normal Water Year	2010
Single-Dry Water Year	1977
Multiple-Dry Water Years	2013-2015

Riverside-Arlington Subbasin

The sole source of potable water supply for the District and for all water users in the Rubidoux Community is groundwater extracted from the southern portion of the Riverside-Arlington Subbasin (also referred to herein as the Riverside Basin) of the Upper Santa Ana Valley Groundwater Basin. The Basin encompasses the District's entire service area.

The District currently does not purchase or otherwise obtain water from a wholesale water supplier, and recycled water is not currently available to the District. The District expects that groundwater extracted from the Basin by six potable and six non-potable (irrigation only) groundwater wells will continue to be its primary (and possibly only) source of water through the year 2040, and possibly beyond.

The District extracts groundwater from the Riverside-Arlington Subbasin (also referred to herein as the Riverside Basin) as its source of water supply. *California's Groundwater Bulletin 118* (2003), prepared by DWR, contains supplemental information that is updated as it becomes available, and data for the Riverside-Arlington Subbasin was last updated in 2004. The Riverside Basin encompasses a surface area of 58,600 acres (92 square miles) within portions of Riverside and San Bernardino Counties. The Riverside Basin underlies part of the Santa Ana River Valley in northwestern Riverside County and southwestern San Bernardino County and is bounded by impermeable rocks of Box Springs Mountains on the southeast, Arlington Mountain on the south, La Sierra Heights and Mount Rubidoux on the northwest, and the Jurupa Mountains on the north.

The Upper Santa Ana Valley Groundwater Basin is adjudicated, as set forth in Judgment No. 78426 (also referred to herein as the Basin Judgment). According to Section IX(b) of the Basin Judgment, entered April 17, 1969, "over any five-year period, there may be extracted from such Basin Area, without replenishment obligation, an amount equal to five times such annual average for the Basin Area; provided, however, that if extractions in any year exceed such average by more than 20 percent, Western [Western Municipal Water District] shall provide replenishment in the following year equal to the excess extractions over such 20 percent peaking allowance."

The Basin Judgment required the annual determination of extractions from the Riverside Basin and further required that Western replenish said basin if the annual extractions exceed the quantities allowed by the judgment. Replenishment has never been required previously, but if replenishment is ever required, the costs for such replenishment would potentially be allocable to the groundwater extractors, including RCSD.

In August 2015, DWR released a draft list of 21 groundwater basins and subbasins significantly overdrafted by "excessive" pumping in response to a series of executive orders issued by Governor Brown since January 2014. The Riverside-Arlington Subbasin was not included in this list. DWR published the final list in January 2016, with no changes to the designation of the Riverside-Arlington Subbasin.

Water Demand AnalysisTable 2

TABLE 3-1 BASE DAILY PER CAPITA WATER USE (BASELINE)				
Year	Estimated Service Area Population ⁽¹⁾	AF/yr ⁽²⁾	Gross Water Use	
			gpd	gpcd
	A	B	C (B x 43560 x 7.48/365)	D (C + A)
1999	24,856	5,466	4,879,398	196
2000	25,367	5,631	5,026,690	198
2001	25,850	5,922	5,286,461	205
2002	26,340	6,733	6,010,426	228
2003	26,824	6,113	5,456,963	203
2004	27,305	6,595	5,887,235	216
2005	27,780	6,304	5,627,465	203
2006	28,251	6,841	6,106,835	216
2007	28,717	6,894	6,154,147	214
2008	29,179	6,511	5,812,250	199
Baseline (Average of Gross Water Use for 1999-2008)				208

Rubidoux Community Service District Fees

<u>WATER METER SIZE</u>	<u>EDU's</u>	<u>FLOW RATE</u>	<u>MAX FIRE FLOW</u>
**5/8"	0.67		
3/4"	1.00	15 gpm	30 gpm
1"	1.67	25 gpm	50 gpm
1 1/2"	3.33	50 gpm	100 gpm
2"	5.33	80 gpm	
3"	10.00	150 gpm	
4"	16.67	250 gpm	
6"	33.33	500 gpm	
8"	53.33	800 gpm	
10"	80.00	1,200 gpm	

<u>WATER METER SIZE</u>	<u>WATER CAPACITY FEES</u>
**5/8"	\$4,556
3/4"	\$6,800
1"	\$11,356
1 1/2"	\$22,644
2"	\$36,244
3"	\$68,000
4"	\$113,356
6"	\$226,644
8"	\$362,644
10"	\$544,000

FIRE MITIGATION
 Residential = \$815.00/Unit
 Commercial (CII) = \$0.41/sqft

SEWER CAPACITY FEES
 EDU (300 gallons per day) = \$5.200
 (Based on water meter size)

<u>WATER METER SIZE</u>	<u>WATER METER FEES</u>
3/4"	\$275
1"	\$325
1 1/2"	\$420
2"	\$625
3"	\$Actual
4"	\$Actual
6"	\$Actual
8"	\$Actual
10"	\$Actual

** 5/8" meter size for calculating per unit cost of multi-unit structures

File: S:\Engineering\Will Serve Letters\billing Units (Eff. 7-21-16)

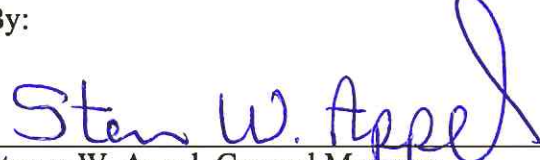
By: 
 Steven W. Appel, General Manager
 Rubidoux Community Services District

Date: 10-30-19



**BOARD OF DIRECTORS
ENGINEERING AND PLANNING COMMITTEE
STAFF REPORT**

DATE: March 11, 2020
TO: Engineering and Planning Committee
FROM: Clarence Mansell Jr., General Manager
SUBJECT: CONSIDER AN AGREEMENT WITH EVOQUA WATER TECHNOLOGIES FOR THE WELL 41 ION EXCHANGE TREATMENT PROJECT RESIN INSTALLATION

BACKGROUND:

At the March 9, 2019 Mid-Year Budget Workshop and Water Reliability Workshop, West Valley Water District (“District”) staff reported on the status of the system and pointed out a potential for not having adequate water supply to meet the high water summer demands. To address this issue, District staff has embarked upon the Emergency Well Optimization project.

On April 6, 2019, the Board of Directors authorized the General Manager to issue emergency contracts to approved vendors not to exceed \$335,000.00 in total without prior approval of the Board. The contracts were to rehabilitate, lower and/or add treatment systems to wells that staff determined are in need of such services.

The Well 41 Ion Exchange Treatment Project Resin Installation is a part of the Emergency Well Optimization project. The project includes the purchase of resin media for Well 41 ion exchange treatment which has been approved for use at the well by the State Water Resources Control Board, Division of Drinking Water (“DDW”).

DISCUSSION:

The ion exchange vessels and pre-filter were transferred from Zone 2-3 ion exchange system to Well 41. This well can be used to supply water to Zone 2 and can supply an average of 2,215 GPM when operational. A permit amendment has been approved by the DDW to utilize the ion exchange vessels at Well 41 for perchlorate removal. The two (2) vessels will require initial resin fill services and the DDW permit amendment specifies to use Dowex PSR2 Plus resin. Three (3) firms were asked to submit a quote for the Well 41 Ion Exchange Treatment Project Resin Installation – Evoqua Water Technologies (“Evoqua”), Purolite, and Carbon Activated Corporation. The three (3) quotes are summarized below:

Firm	Quote
Evoqua	\$177,743.06
Purolite	\$164,745.89
Carbon Activated Corporation	No quote

Purolite provided a quote for a different type of resin and Carbon Activated Corporation informed the District, Evoqua has sole source of Dowex PRS2 Plus resin attached as **Exhibit A**. Attached as **Exhibit B** is the proposal from Evoqua.

FISCAL IMPACT:

This was a budgeted item in the Fiscal Year 2019/20 Capital Improvement Budget under the W19002 Well 41 Ion Exchange Treatment with a current budget of \$747,634.98. Sufficient funds are available in the project budget to cover the cost. A summary of the requested budget is as follows:

CIP FY 2019-2020 Project Name	Project Budget	Expenditures	Budget Balance	Resin Cost	Remaining Budget
W19002 Well 41 Ion Exchange Treatment	\$970,785.00	\$223,150.22	\$747,634.98	\$177,743.06	\$569,891.92

STAFF RECOMMENDATION:

It is recommended that the Engineering, Operations, and Planning Committee approve an Agreement with Evoqua for the Well 41 Ion Exchange Treatment Project Resin Installation in the amount of \$177,743.06 and have this item considered by the full Board of Directors at a future meeting and authorize the General Manager to execute the necessary documents.

Respectfully Submitted,



Clarence Mansell Jr, General Manager

RMG:ce

ATTACHMENT(S):

1. Exhibit A - Evoqua Sole Source Justification
2. Exhibit B - Evoqua Proposal

EXHIBIT A

Sole Source Justification

Well 41 Ion Exchange Treatment Project Resin Installation

1. Why do we need to acquire the goods and services?

The Well 41 Ion Exchange Treatment Project Resin Installation is a part of the Emergency Well Optimization project. The project includes the purchase of resin media for perchlorate removal.

2. Why are the goods or services the only ones that can meet your needs?

The ion exchange treatment of Dowex PRS2 Plus resin has been approved for use at Well 41 by the State Water Resources Control Board, Division of Drinking Water ("DDW").

3. Were alternative goods/services evaluated? If yes, why are those unacceptable?

Dowex PRS2 Plus resin is produced exclusively for Evoqua Water Technologies ("Evoqua").

4. What efforts were made to get the best price?

The same resin was required to be selected prior to the amended permit and at that time West Valley Water District ("District") chose Dowex PRS2 resin because the same resin was being used at Well 18A and at the Zone 2-3.

5. Why is price fair and reasonable?

The price is fair given that Evoqua has sole source of the resin the District needs.

6. What impact is there if the sole source is not used?

The project will be delayed. The use of a different resin needs to be tested and approved by DDW.

Recommendation:

It is recommended purchasing Dowex PRS2 Plus resin from Evoqua for Well 41.

Signature: 
Name: Rosa M. Gutierrez, P.E.

Date: 03/05/2020

Title: Senior Engineer

Signature: 
Name: Clarence C. Mansell, Jr.

Date: 03/05/2020

Title: General Manager

EXHIBIT B



Confidentiality Statement

This document and all information contained herein are the property of Evoqua Water Technologies LLC. The design concepts and information contained herein are proprietary to Evoqua Water Technologies LLC and are submitted in confidence. They are not transferable and must be used only for the purpose for which the document is expressly loaned. They must not be disclosed, reproduced, loaned or used in any other manner without the express written consent of Evoqua Water Technologies LLC. In no event shall they be used in any manner detrimental to the interest of Evoqua Water Technologies LLC. All patent rights are reserved. Upon the demand of Evoqua Water Technologies LLC, this document, along with all copies or extracts, and all related notes and analyses, must be returned to Evoqua Water Technologies LLC or destroyed, as instructed by Evoqua Water Technologies LLC. Acceptance of the delivery of this document constitutes agreement to these terms and conditions.

Terms and Conditions

In the event Evoqua Water Technologies LLC is the selected vendor for the products and services contemplated in the subject bid, Evoqua Water Technologies LLC desires to negotiate a mutually agreeable set of terms and conditions to govern such transaction (including issues such as warranty, indemnity, appropriate limitations of liability and other substantive terms and conditions). Evoqua Water Technologies LLC will not be obligated to supply products or services pursuant to such bid unless and until the parties have entered into an agreement with terms and conditions mutually agreed in writing by the parties.



Evoqua Water Technologies LLC

January 29, 2020

Proposal #: 11.15.2019.PAT.R1

Joanne Chan
West Valley Water District
855 W. Base Line · P.O. Box 920
Rialto, CA 92377

Subject: Well 41 Water Treatment Facility Perchlorate Selective Resin Media Purchase and Installation Services

Dear Joanne:

Evoqua Water Technologies LLC is pleased to provide this proposal to the West Valley Water District for the initial resin fill services for the two (2) vessels at Well 41 Treatment plant.

Evoqua appreciates the business we've done at West Valley as a trusted supplier. We are committed to making sure your systems are operating at the peak performance, and your citizens get reliable, compliant drinking water. Evoqua continually goes beyond when it comes to customer service as shown in our history with West Valley. We are there to help troubleshoot systems. We've installed items on the weekend. We really do care about making sure West Valley is running their treatment systems optimally.

We put that kind of attention into every change out we perform and look forward to continuing our services at Well 41.

The following proposal provides pricing for PSR2 Plus.

Please find the following scope of supply and pricing. Let me know if you have any questions. We do have resin in inventory and can provide a change out at your convenience. Thank you again for the opportunity to work with you on this.

Sincerely,

Patricia Tinnerino
Sales Engineer
Evoqua Water Technologies
714-262-1560
Patricia.tinnerino@evoqua.com

Attachments:

Scope of Supply
Pricing
PSR-2Plus Data Sheet
Terms



SCOPE OF SUPPLY

Seller's scope of supply is as follows below (the "Well Conditions"):

TABLE ONE:

Description	Well 41
Operational Flow Rate	2200 gpm
Peak Flow Rate	2200 gpm
Operational Schedule	Not available
Daily Volume (average)	Not defined
Chloride (max)	11 mg/l
Nitrate (max) (as NO ₃)	6.5 mg/l
Sulfate (max)	32 mg/l
Perchlorate (max)	5.4 ppb
Alkalinity (max) (as CaCO ₃)	160 mg/l

Estimated Throughput – 353 cf PSR2 Plus per vessel

620,000 BV for the initial lead bed (490 days at 2200 gpm)

490,000 BV for subsequent beds (390 days at 2200 gpm)

These are based on 5.4 ppb perchlorate in the influent and running the lead bed to 4 ppb. More throughput is possible if they are willing to run longer and allow more perchlorate in the final influent. I assume influent will be less than 4 since it is 1.1 on average, in which case the resin works as a buffer and they can run until the beds plug with solids. No throughput warranty is provided with this proposal.

Time Line:

Day 1 – Chlorinate vessels

Day 2 – Flush vessels and sample for Bac T and HPC

Day 4 – Get Bac T and HPC results

Day 5- Prep resin (Evoqua at LA Branch)

Day 7 – Fill vessels. Flush vessels and sample for Bac T and HPC

Day 9 (end of day) - Get Bac T and HPC results and put online



Scope of Services – Disinfection and Initial Fill

The following identifies each activity to be provided by Evoqua Water Technologies. (Please note that a more detailed description of each of the processes follows):

- Using appropriate personnel protective equipment apply a sanitizing chlorine solution.
- Retain chlorine within the closed, chlorinated IX vessels for at least 24 hours and no more than 72 hours. Chlorinated water to flow through all face piping to ensure complete disinfection.
- Introduce potable water into the IX vessel and to remove chlorine from the interior of the vessel until an appropriate chlorine residual is achieved.
- Obtain water sample from the newly disinfected vessels and perform BAC-T and total Coliform analyses at a state-licensed analytical laboratory.
- Upon notice that the bacteriological tests are negative, Evoqua will proceed with the resin loading operation.
- Deliver and load washed, virgin resin in the IX vessel as a slurry.
- Following testing, inspection, and disinfection of the system, two (2) IX resin vessels shall be filled with a minimum of 353 cubic feet/each of PSR2 Plus resin (706 cf total).
- Obtain water sample from the newly loaded vessel and perform BAC-T and total Coliform analyses at a state-licensed analytical laboratory.
- Confirm that bacteriological tests are negative.
- If bacteriological tests are positive, sanitize the vessel and resin, and perform new laboratory tests to verify that bacteriological tests are negative.

Scope of Services – Resin Change out Event (future)

The following identifies each activity to be provided by Evoqua Water Technologies. (Please note that a more detailed description of each of the processes follows):

- Remove spent resin using slurry techniques to place media directly into trucks.
- Open the vessel manway to pressure wash and remove residual resin from the inside of the vessel.
- Haul removed resin to licensed facility for thermal destruction. Provide manifests and certificates documenting thermal destruction of spent resin.
- Inspect and photograph empty vessel(s). Identify any equipment damage or service requirements. Provide photographs to District staff.
- Deliver and load washed, virgin resin in the IX vessel as a slurry.
- Following testing, inspection, and disinfection of the system, two (2) IX resin vessels shall be filled with a minimum of 353 cubic feet/each of PSR2 Plus resin (706 cf total).
- Obtain water sample from the newly loaded vessel and perform BAC-T and total Coliform analyses at a state-licensed analytical laboratory.
- Confirm that bacteriological tests are negative.
- If bacteriological tests are positive, sanitize the vessel and resin, and complete new laboratory tests to verify that bacteriological tests are negative.



As part of our proposal, Evoqua Water Technologies would like to detail the procedures and services that will be a part of this resin installation for your potable water use.

Resin Pre-Installation Services

Evoqua Water Technologies shall deliver resin in company owned and maintained trailers used solely for the transport of potable water resin. Trailers shall be thoroughly cleaned and sanitized prior to filling with resin and shall be lined or constructed with materials suitable for transporting resin that will be in contact with potable water.

Evoqua Water Technologies will provide a proprietary pre-conditioning of the resin in our plant prior to the delivery and installation at the Well 41 Treatment Plant. The resin will be prepared in the Evoqua Water Technologies Los Angeles resin processing plant utilizing a proprietary and SWRDB approved process. Our Evoqua Water Technologies owned and operated slurry trailers, along with the hoses, connections and transfer pumps, will be disinfected in our plant, using AWWA recommended methods for disinfection. The washing and pre-treatment process of the ion exchange resin will include rinse-up at our Los Angeles facility. This process will minimize the rinse-up process to no more than an estimated two bed volumes per resin bed used for rinse up at the site.

Resin Removal and Vessel Cleaning (only if required)

The interior of the vessel will be scrubbed clean, first with the resin still in the vessel to make it easier to access the top. Confined space is required. Once the top is clean, the resin will be removed. Removal of the spent Ion Exchange Resin shall be accomplished by pressurizing the vessel with compressed air and/or water to displace the spent resin to the Evoqua owned and operated slurry trailer. Resin shall be transferred as water slurry only, using air pressure on the trailer as the motive force. After the resin is removed, Evoqua will finish cleaning the interior of the vessel.

Resin Delivery/Fill Services

Resin shall be transferred as water slurry only, using air pressure on the trailer as the motive force. Evoqua Water Technologies will perform a site safety review which will be held to best determine the safest methods for making the resin transfer. All connections will be inspected and disinfected prior to making hose connections for the slurry transfer. Fresh resin will be hydro-pneumatically slurried into each tank and slurry water will be sent to your discharge location, drain, pond, storage tank or other provided by owner, at the vessel site. After completion of the resin slurry, the tank will be filled with clean distribution water (to be provided by West Valley Water District) and pressurized to check for leaks. Once leak test is complete, the site will be cleaned to its prior level. Clean utility water to be provided to Evoqua Water Technologies by West Valley Water District.

Spent Resin Disposal Services

Evoqua Water Technologies will provide disposal of the spent resin as a non-hazardous spent material at the Covanta disposal facility which will include incineration of the resin at the local waste-to-energy facility. This facility has been environmentally audited for compliance by Evoqua Water Technologies. The incineration of the resin as final disposal includes issuance of a Certificate of Destruction of the spent resin by Evoqua Water Technologies, once it has been processed at the Covanta facility. Pricing has been included for this disposal method.

PRICING –PSR2 Plus

	Qty	\$/cu ft	Total \$
Vessel Disinfection	1	\$ 1,746.10	\$ 1,746.10
Resin	706	\$ 214.29	\$ 151,288.74
Labor	706	\$ 18.39	\$ 12,983.34
Tax on resin only (7.75%)	706	\$ 16.61	\$ 11,724.88
Total			\$ 177,743.06

Also Please Note:

- Proposal pricing valid for 30 days.
- Evoqua Standard Terms and Conditions are attached and are incorporated into this proposal by reference
- Terms of payment are net 30 days, 100% upon completion
- Seller's price does not include, and Seller shall not be responsible for, any taxes, permits, tariffs, duties or fees (or any incremental increases to such taxes, permits, tariffs, duties or fees enacted by governmental agencies) unless specifically agreed herein or otherwise by Seller in writing.
- FOB factory, freight allowed to jobsite.



Product Data Sheet

DOWEX™ PSR2 Plus Cl Ion Exchange Resin

For Selective Removal of Perchlorate from Potable Water

Description

DOWEX™ PSR2 Plus Cl Ion Exchange Resin is a strong base anion exchange resin for the selective removal of perchlorate from potable water.

Designed to offer exceptional selectivity for perchlorate, the gel matrix also helps achieve high capacity while the uniform particle size (UPS) allows operation at lower pressure losses compared to conventional perchlorate removal resins.

Typical Physical and Chemical Properties

Matrix	Styrene-divinylbenzene, gel
Type	Strong base anion
Physical Form	White to yellow spherical beads
Ionic Form as Shipped	Cl ⁻ Form
Total Exchange Capacity	≥ 0.7 eq/L
Water Retention Capacity	25 – 35%
Particle Size	
Particle Diameter ^b	700 ± 50 μm
Uniformity Coefficient	≤ 1.1
< 300 μm	1% max
Particle Density	1.07 g/mL
Bulk Density, as Shipped ^c	690 g/L (43 lb/ft ³)

^b For additional particle size information, please refer to the [Particle Size Distribution Cross Reference Chart](#) (Form No. 177-01775).

^c As per the backwashed and settled density of the resin, determined by ASTM D-2187.

Suggested Operating Conditions

Maximum Operating Temperature	60°C (140°F)
pH Range	0 – 14
Bed Depth, min.	1000 mm (3.1 ft)
Typical Service Flowrate	4 – 64 BV*/h (0.5 – 8 gpm/ft ³)
Typical Linear Velocity	12 – 54 m/h (5 – 22 gpm/ft ²)

* 1 BV (Bed Volume) = 1 m³ solution per m³ resin or 7.5 gal per ft³ resin

Please contact your Dow representative for system design and application testing details.

Commissioning and Limits of Use

DOWEX™ PSR2 Plus CI Resin is suitable for use in potable water applications after an initial commissioning pretreatment at ambient temperature.

Note

These resins may be subject to drinking water application restrictions in some countries.

Please check the application status before use and sale.

Hydraulic Characteristics

Pressure drop data for DOWEX™ PSR2 Plus CI Resin as a function of service flowrate at 20°C (68°F) is shown in Figure 1. The pressure drop for other water temperatures can be calculated with the provided equations. Pressure drop data are valid at the start of the service run with clean water and a correctly classified bed.

Figure 1: Pressure Drop

Temperature = 20°C (68°F)

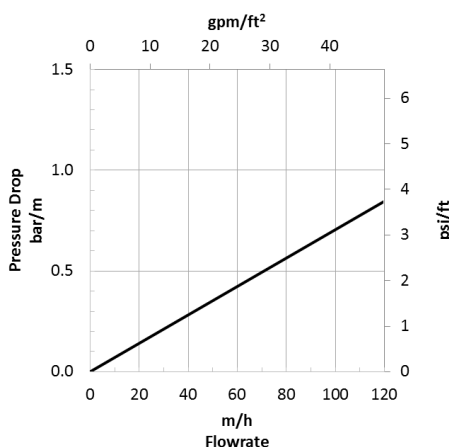

For other temperatures use:

$$P_T = P_{20^\circ\text{C}} / (0.026 T_{\text{C}} + 0.48), \text{ where } P \equiv \text{bar/m}$$

$$P_T = P_{68^\circ\text{F}} / (0.014 T_{\text{F}} + 0.05), \text{ where } P \equiv \text{psi/ft}$$

Packaging

- 5-ft³ (0.14-m³) fiber drums
- 1000-L (264-gal) super sacks

Product Stewardship

Dow has a fundamental concern for all who make, distribute, and use its products, and for the environment in which we live. This concern is the basis for our product stewardship philosophy by which we assess the safety, health, and environmental information on our products and then take appropriate steps to protect employee and public health and our environment. The success of our product stewardship program rests with each and every individual involved with Dow products—from the initial concept and research, to manufacture, use, sale, disposal, and recycle of each product.

Customer Notice

Dow strongly encourages its customers to review both their manufacturing processes and their applications of Dow products from the standpoint of human health and environmental quality to ensure that Dow products are not used in ways for which they are not intended or tested. Dow personnel are available to answer your questions and to provide reasonable technical support. Dow product literature, including safety data sheets, should be consulted prior to use of Dow products. Current safety data sheets are available from Dow.

For more information, contact our Customer Information Group:

Asia Pacific	+86 21 3851 4988
Europe, Middle East, Africa	+31 115 672626
Latin America	+55 11 5184 8722
North America	1-800-447-4369

www.dowwaterandprocess.com

WARNING: Oxidizing agents such as nitric acid attack organic ion exchange resins under certain conditions. This could lead to anything from slight resin degradation to a violent exothermic reaction (explosion). Before using strong oxidizing agents, consult sources knowledgeable in handling such materials.

NOTICE: No freedom from infringement of any patent owned by Dow or others is to be inferred. Because use conditions and applicable laws may differ from one location to another and may change with time, Customer is responsible for determining whether products and the information in this document are appropriate for Customer's use and for ensuring that Customer's workplace and disposal practices are in compliance with applicable laws and other government enactments. The product shown in this literature may not be available for sale and/or available in all geographies where Dow is represented. The claims made may not have been approved for use in all countries. Dow assumes no obligation or liability for the information in this document. References to "Dow" or the "Company" mean the Dow legal entity selling the products to Customer unless otherwise expressly noted. NO WARRANTIES ARE GIVEN; ALL IMPLIED WARRANTIES OF MERCHANTABILITY OR FITNESS FOR A PARTICULAR PURPOSE ARE EXPRESSLY EXCLUDED.

All information set forth herein is for informational purposes only. This information is general information and may differ from that based on actual conditions. Please note that physical properties may vary depending on certain conditions and while operating conditions stated in this document are intended to lengthen product lifespan and/or improve product performance, it will ultimately depend on actual circumstances and is in no event a guarantee of achieving any specific results. Nothing in this document should be treated as a warranty by Dow.



Water Quality Association

2/8/2019



CERTIFIED DRINKING WATER SYSTEM COMPONENTS

NSF/ANSI 61 - 2017: Drinking Water System Components - Health Effects

The Dow Chemical Company

2030 Willard H Dow Center

Midland, MI 48674

United States

<http://www.dow.com> (<http://www.dow.com>)

Product Type: Ion Exchange Resin

Brand Name	Model	Water Contact Temp	Water Contact Material	Size
AMBERLITE™	AMBERLITE PWA15 Anion Exchange Resin ⁴	Cold (23C)	SYN	525-625 um
AMBERLITE™	AMBERLITE PWA17 Anion Exchange Resin ³	Cold (23C)	SYN	16x50 mesh
AMBERLITE™	AMBERLITE SF120ES K ¹¹	Cold (23C)	SYN	25x70 mesh
AMBERLITE™	AMBERLITE™ HPR1100 Na ⁴	Cold (23C)	SYN	525-625 um
AMBERLITE™	AMBERLITE™ SCAV3 Cl ²	Cold (23C)	SYN	16x50 mesh
DOWEX	DOWEX 1 Anion Exchange Resin ¹⁵	Cold (23C)	SYN	16x50 mesh

DOWEX	DOWEX MARATHON C Cation Exchange Resin ⁴	Cold (23C)	SYN	525-625 um
DOWEX	DOWEX PSR-2 Anion Exchange Resin ^{1,2}	Cold (23C)	SYN	16x50 mesh
DOWEX	DOWEX PSR2 Plus (CL) Ion Exchange Resin ^{12,13}	Cold (23C)	SYN	0.5 - 0.9 mm
DOWEX	DOWEX SAR Anion Exchange Resin ⁵	Cold (23C)	SYN	16x50 mesh
DOWEX	DOWEX TAN-1 Anion Exchange Resin ⁷	Cold (23C)	SYN	16x50 mesh
DOWEX	Dowex RSC Na Cation Exchange Resin ⁸	Cold (23C)	SYN	16x50 mesh
DOWEX	HCR-S Cation Exchange Resin	Cold (23C)	SYN	16x50 mesh
DOWEX	HCR-S Cation Exchange Resin ⁶	Cold (23C)	SYN	300-1200 um

Product Type: Adsorption Media

AMBERSORB	AMBERSORB™ 4652 Adsorbent ¹⁴	Cold (23C)	SYN	20x60 mesh
AMBERSORB	AMBERSORB™ 560 Adsorbent ¹⁴	Cold (23C)	SYN	20x60 mesh

Facility: Fombio, Italy

Product Type: Ion Exchange Resin

Brand Name	Model	Water Contact Temp	Water Contact Material	Size
DOWEX	Dowex HCR-S/S Cation Exchange Resin	Cold (23C)	SYN	16x50 mesh

Facility: Midland, MI

Product Type: Ion Exchange Resin

Brand Name	Model	Water Contact Temp	Water Contact Material	Size
DOWEX	HCR-S/S Cation Exchange Resin ^{9,4,10}	Cold (23C)	SYN	16x50 mesh

¹ Anion Resin

² Certified for water treatment plant applications. This product has not been evaluated for point of use applications.

³ This product is certified with a minimum flow rate of = 0.4 gpm/ft³ of media.

⁴ This product is certified with a minimum flow rate of = 0.8 gpm/ft³ of media.

⁵ Flush at least 3 BV water.

⁶ This product is certified with a minimum of = 1.0 gpm/ft³ of media.

⁷ Flush 3 BV water at < 20 BV/hour.

⁸ This product is certified with a minimum flow rate of = 0.72 gpm/ft³ of media.

⁹ Flush 3 BV water at > 20 BV/hour.

¹⁰ The regeneration water consumption is at least .21 liters of regeneration water consumption per 100 grams of media.

¹¹ This product has not been evaluated for Point-of-Entry (POE) end-use.

¹² This product is certified with a minimum flow rate of 0.38 gpm/ft³ of media

¹³ For conditioning the resin; soak 1 hour with water. Then, rinse with RO/DI water at 10BV/hr = 0.044 gallons/minute for 20BV.

¹⁴ This product is certified for Process Media Applications (small and large systems).

¹⁵ This product is certified with a minimum flow rate of 0.4 gpm/ft³ of media.

EVOQUA WATER TECHNOLOGIES LLCStandard Terms of Sale

1. **Applicable Terms.** These terms govern the purchase and sale of equipment, products, related services, leased products, and media goods if any (collectively herein "Work"), referred to in Seller's proposal ("Seller's Documentation"). Whether these terms are included in an offer or an acceptance by Seller, such offer or acceptance is expressly conditioned on Buyer's assent to these terms. Seller rejects all additional or different terms in any of Buyer's forms or documents.
2. **Payment.** Buyer shall pay Seller the full purchase price as set forth in Seller's Documentation. Unless Seller's Documentation specifically provides otherwise, freight, storage, insurance and all taxes, levies, duties, tariffs, permits or license fees or other governmental charges relating to the Work or any incremental increases thereto shall be paid by Buyer. If Seller is required to pay any such charges, Buyer shall immediately reimburse Seller. If Buyer claims a tax or other exemption or direct payment permit, it shall provide Seller with a valid exemption certificate or permit and indemnify, defend and hold Seller harmless from any taxes, costs and penalties arising out of same. All payments are due within 30 days after receipt of invoice. Buyer shall be charged the lower of 1 ½% interest per month or the maximum legal rate on all amounts not received by the due date and shall pay all of Seller's reasonable costs (including attorneys' fees) of collecting amounts due but unpaid. All orders are subject to credit approval by Seller. Back charges without Seller's prior written approval shall not be accepted.
3. **Delivery.** Delivery of the Work shall be in material compliance with the schedule in Seller's Documentation. Unless Seller's Documentation provides otherwise, delivery terms are ExWorks Seller's factory (Incoterms 2010). Title to all Work shall pass upon receipt of payment for the Work under the respective invoice. Unless otherwise agreed to in writing by Seller, shipping dates are approximate only and Seller shall not be liable for any loss or expense (consequential or otherwise) incurred by Buyer or Buyer's customer if Seller fails to meet the specified delivery schedule.
4. **Ownership of Materials and Licenses.** All devices, designs (including drawings, plans and specifications), estimates, prices, notes, electronic data, software and other documents or information prepared or disclosed by Seller, and all related intellectual property rights, shall remain Seller's property. Seller grants Buyer a non-exclusive, non-transferable license to use any such material solely for Buyer's use of the Work. Buyer shall not disclose any such material to third parties without Seller's prior written consent. Buyer grants Seller a non-exclusive, non-transferable license to use Buyer's name and logo for marketing purposes, including but not limited to, press releases, marketing and promotional materials, and web site content.
5. **Changes.** Neither party shall implement any changes in the scope of Work described in Seller's Documentation without a mutually agreed upon change order. Any change to the scope of the Work, delivery schedule for the Work, any Force Majeure Event, any law, rule, regulation, order, code, standard or requirement which requires any change hereunder shall entitle Seller to an equitable adjustment in the price and time of performance.
6. **Force Majeure Event.** Neither Buyer nor Seller shall have any liability for any breach or delay (except for breach of payment obligations) caused by a Force Majeure Event. If a Force Majeure Event exceeds six (6) months in duration, the Seller shall have the right to terminate the Agreement without liability, upon fifteen (15) days written notice to Buyer, and shall be entitled to payment for work performed prior to the date of termination. "Force Majeure Event" shall mean events or circumstances that are beyond the affected party's control and could not reasonably have been easily avoided or overcome by the affected party and are not substantially attributable to the other party. Force Majeure Event may include, but is not limited to, the following circumstances or events: war, act of foreign enemies, terrorism, riot, strike, or lockout by persons other than by Seller or its sub-suppliers, natural catastrophes or (with respect to on-site work), unusual weather conditions.
7. **Warranty.** Subject to the following sentence, Seller warrants to Buyer that the (i) Work shall materially conform to the description in Seller's Documentation and shall be free from defects in material and workmanship and (ii) the Services shall be performed in a timely and workmanlike manner. Determination of suitability of treated water for any use by Buyer shall be the sole and exclusive responsibility of Buyer. The foregoing warranty shall not apply to any Work that is specified or otherwise demanded by Buyer and is not manufactured or selected by Seller, as to which (i) Seller hereby assigns to Buyer, to the extent assignable, any warranties made to Seller and (ii) Seller shall have no other liability to Buyer under warranty, tort or any other legal theory. The Seller warrants the Work, or any components thereof, through the earlier of (i) eighteen (18) months from delivery of the Work or (ii) twelve (12) months from initial operation of the Work or ninety (90) days from the performance of services (the "Warranty Period"). If Buyer gives Seller prompt written notice of breach of this warranty within the Warranty Period, Seller shall, at its sole option and as Buyer's sole and exclusive remedy, repair or replace the subject parts, re-perform the Service or refund the purchase price. Unless otherwise agreed to in writing by Seller, (i) Buyer shall be responsible for any labor required to gain access to the Work so that Seller can assess the available remedies and (ii) Buyer shall be responsible for all costs of installation of repaired or replaced Work. If Seller determines that any claimed breach is not, in fact, covered by this warranty, Buyer shall pay Seller its then customary charges for any repair or replacement made by Seller. Seller's warranty is conditioned on Buyer's (a) operating and maintaining the Work in accordance with Seller's instructions, (b) not making any unauthorized repairs or alterations, and (c) not being in default of any payment obligation to Seller. Seller's warranty does not cover (i) damage caused by chemical action or abrasive material, misuse or improper installation (unless installed by Seller) and (ii) media goods (such as, but not limited to, resin, membranes, or granular activated carbon media) once media goods are installed. THE WARRANTIES SET FORTH IN THIS SECTION 7 ARE THE SELLER'S SOLE AND EXCLUSIVE WARRANTIES AND ARE SUBJECT TO THE LIMITATION OF LIABILITY PROVISION BELOW. SELLER MAKES NO OTHER WARRANTIES OF ANY KIND, EXPRESS OR IMPLIED, INCLUDING WITHOUT LIMITATION, ANY WARRANTY OF MERCHANTABILITY OR FITNESS FOR PURPOSE.
8. **Indemnity.** Seller shall indemnify, defend and hold Buyer harmless from any claim, cause of action or liability incurred by Buyer as a result of third party claims for personal injury, death or damage to tangible property, to the extent caused by Seller's negligence. Seller shall have the sole authority to direct the defense of and settle any indemnified claim. Seller's indemnification is conditioned on Buyer (a) promptly, within the Warranty Period, notifying Seller of any claim, and (b) providing reasonable cooperation in the defense of any claim.

9. **Assignment.** Neither party may assign this Agreement, in whole or in part, nor any rights or obligations hereunder without the prior written consent of the other party; provided, however, the Seller may assign its rights and obligations under these terms to its affiliates or in connection with the sale or transfer of the Seller's business and Seller may grant a security interest in the Agreement and/or assign proceeds of the agreement without Buyer's consent.

10. **Termination.** Either party may terminate this agreement, upon issuance of a written notice of breach and a thirty (30) day cure period, for a material breach (including but not limited to, filing of bankruptcy, or failure to fulfill the material obligations of this agreement). If Buyer suspends an order without a change order for ninety (90) or more days, Seller may thereafter terminate this Agreement without liability, upon fifteen (15) days written notice to Buyer, and shall be entitled to payment for work performed, whether delivered or undelivered, prior to the date of termination.

11. **Dispute Resolution.** Seller and Buyer shall negotiate in good faith to resolve any dispute relating hereto. If, despite good faith efforts, the parties are unable to resolve a dispute or claim arising out of or relating to this Agreement or its breach, termination, enforcement, interpretation or validity, the parties will first seek to agree on a forum for mediation to be held in a mutually agreeable site. If the parties are unable to resolve the dispute through mediation, then any dispute, claim or controversy arising out of or relating to this Agreement or the breach, termination, enforcement, interpretation or validity thereof, including the determination of the scope or applicability of this agreement to arbitrate, shall be determined by arbitration in Pittsburgh, Pennsylvania before three arbitrators who are lawyers experienced in the discipline that is the subject of the dispute and shall be jointly selected by Seller and Buyer. The arbitration shall be administered by JAMS pursuant to its Comprehensive Arbitration Rules and Procedures. The Arbitrators shall issue a reasoned decision of a majority of the arbitrators, which shall be the decision of the panel. Judgment may be entered upon the arbitrators' decision in any court of competent jurisdiction. The substantially prevailing party as determined by the arbitrators shall be reimbursed by the other party for all costs, expenses and charges, including without limitation reasonable attorneys' fees, incurred by the prevailing party in connection with the arbitration. For any order shipped outside of the United States, any dispute shall be referred to and finally determined by the International Center for Dispute Resolution in accordance with the provisions of its International Arbitration Rules, enforceable under the New York Convention (Convention on the Recognition and Enforcement of Foreign Arbitral Awards) and the governing language shall be English.

12. **Export Compliance.** Buyer acknowledges that Seller is required to comply with applicable export laws and regulations relating to the sale, exportation, transfer, assignment, disposal and usage of the Work provided under this Agreement, including any export license requirements. Buyer agrees that such Work shall not at any time directly or indirectly be used, exported, sold, transferred, assigned or otherwise disposed of in a manner which will result in non-compliance with such applicable export laws and regulations. It shall be a condition of the continuing performance by Seller of its obligations hereunder that compliance with such export laws and regulations be maintained at all times. BUYER AGREES TO INDEMNIFY AND HOLD SELLER HARMLESS FROM ANY AND ALL COSTS, LIABILITIES, PENALTIES, SANCTIONS AND FINES RELATED TO NON-COMPLIANCE WITH APPLICABLE EXPORT LAWS AND REGULATIONS.

13. **LIMITATION OF LIABILITY.** NOTWITHSTANDING ANYTHING ELSE TO THE CONTRARY, SELLER SHALL NOT BE LIABLE FOR ANY CONSEQUENTIAL, INCIDENTAL, SPECIAL, PUNITIVE OR OTHER INDIRECT DAMAGES, AND SELLER'S TOTAL LIABILITY ARISING AT ANY TIME FROM THE SALE OR USE OF THE WORK, INCLUDING WITHOUT LIMITATION ANY LIABILITY FOR ALL WARRANTY CLAIMS OR FOR ANY BREACH OR FAILURE TO PERFORM ANY OBLIGATION UNDER THE CONTRACT, SHALL NOT EXCEED THE PURCHASE PRICE PAID FOR THE WORK. THESE LIMITATIONS APPLY WHETHER THE LIABILITY IS BASED ON CONTRACT, TORT, STRICT LIABILITY OR ANY OTHER THEORY.

14. **Rental Equipment / Services.** Any leased or rented equipment ("Leased Equipment") provided by Seller shall at all times be the property of Seller with the exception of certain miscellaneous installation materials purchased by the Buyer, and no right or property interest is transferred to the Buyer, except the right to use any such Leased Equipment as provided herein. Buyer agrees that it shall not pledge, lend, or create a security interest in, part with possession of, or relocate the Leased Equipment. Buyer shall be responsible to maintain the Leased Equipment in good and efficient working order. At the end of the initial term specified in the order, the terms shall automatically renew for the identical period unless canceled in writing by Buyer or Seller not sooner than three (3) months nor later than one (1) month from termination of the initial order or any renewal terms. Upon any renewal, Seller shall have the right to issue notice of increased pricing which shall be effective for any renewed terms unless Buyer objects in writing within fifteen (15) days of issuance of said notice. If Buyer timely cancels service in writing prior to the end of the initial or any renewal term this shall not relieve Buyer of its obligations under the order for the monthly rental service charge which shall continue to be due and owing. Upon the expiration or termination of this Agreement, Buyer shall promptly make any Leased Equipment available to Seller for removal. Buyer hereby agrees that it shall grant Seller access to the Leased Equipment location and shall permit Seller to take possession of and remove the Leased Equipment without resort to legal process and hereby releases Seller from any claim or right of action for trespass or damages caused by reason of such entry and removal.

15. **Miscellaneous.** These terms, together with any Contract Documents issued or signed by the Seller, comprise the complete and exclusive statement of the agreement between the parties (the "Agreement") and supersede any terms contained in Buyer's documents, unless separately signed by Seller. No part of the Agreement may be changed or cancelled except by a written document signed by Seller and Buyer. No course of dealing or performance, usage of trade or failure to enforce any term shall be used to modify the Agreement. To the extent the Agreement is considered a subcontract under Buyer's prime contract with an agency of the United States government, in case of Federal Acquisition Regulations (FARs) flow down terms, Seller will be in compliance with Section 44.403 of the FAR relating to commercial items and those additional clauses as specifically listed in 52.244-6, Subcontracts for Commercial Items (OCT 2014). If any of these terms is unenforceable, such term shall be limited only to the extent necessary to make it enforceable, and all other terms shall remain in full force and effect. The Agreement shall be governed by the laws of the Commonwealth of Pennsylvania without regard to its conflict of laws provisions. Both Buyer and Seller reject the applicability of the United Nations Convention on Contracts for the international sales of goods to the relationship between the parties and to all transactions arising from said relationship.

IN WITNESS WHEREOF, the terms and conditions of this proposal are hereby accepted by both Buyer and Seller, who have caused this Agreement to be executed by the signatures of their duly authorized representatives below:

EVOQUA WATER TECHNOLOGIES LLC (SELLER)

NAME: _____

SIGNATURE: _____

TITLE: _____

DATE: _____

BUYER

NAME: _____

SIGNATURE: _____

TITLE: _____

DATE: _____